

EVH-1152S/94

Single 15" Two-Way Coaxial 90° x 40° Full-Range High Efficiency Loudspeaker System



Key Features:

- ND2B 2" (51mm) Diaphragm, 1.4" (36mm) Exit Pure Titanium Compression Driver
- SMX2151 15" (381mm) LF Transducer with Fully Symmetric Drive
- Advanced 4th Order Crossover Network with HF Protection
- Coverage Pattern: 90° x 40° Constant Directivity™ Rotatable Waveguides
- 105 dB Sensitivity, 138 dB Maximum SPL
- System Rating: 500W Continuous, (2000W Peak)
- Active Rating: LF400W/HF40W Continuous (1600W/160W Peak)
- (28) M10 Threaded Suspension Points
- PI Version Available with Gland Nut and Stainless Steel Grille

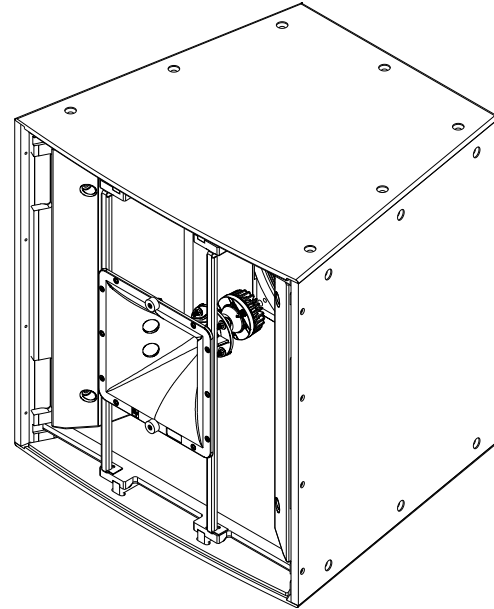

General Description:

The Electro-Voice® EVH-1152S/94 is a high power, 2-way Horn loaded coaxial loudspeaker system that can be used in a variety of applications where excellent quality sound reinforcement, wide bandwidth directivity control, and high efficiency are required in a compact package.

The EVH-1152S/94 utilizes an ND2B and an SMX2151. The ND2B is a high output 2" titanium compression driver, coupled to a rotatable 12" x 12" Constant Directivity™ 90° x 40° waveguide. The new SMX2151 is a high output, low distortion 15" woofer. Developed by EV engineering the motor, suspension, and electrical characteristics of the woofer are optimized to maximize efficiency and minimize distortion. The passive crossover network employs 24 dB/octave slopes for a smooth response in the vocal range, linear off-axis response, and features a comprehensive protection circuit for long term reliability. This combination of technologies results in a smooth response to 16 kHz and excellent pattern control down to 500Hz.

The EVH-1152S/94 features make it ideal for any fixed install application. The trapezoidal enclosure is constructed out of 13 ply, 18mm birch, and coated with EVCoat™ for maximum protection from the elements. PI weather resistant models uses a stainless steel grill grille backed with multiple material layers to prevent weather or humidity ingress. The EVH family of models employ an intelligent combination of superior acoustic design and rigging which allow for vertical and horizontal clusters to be built using any combination of loudspeakers from the entire EVF & EVH Series. 28 suspension points for use with rated eyebolts or EV -I cluster hardware provide low cost, simple rigging solutions. With 5 horn patterns to choose from and an assortment of low frequency and subwoofer loudspeakers, EVH provides you the tools to easily design a custom tailored solution, no matter what the application or budget. The innovative input panel can be customized to one of three input choices, including a phoenix style connector (included in all standard models), dual NL4 type connectors, or a gland nut cover plate (for weatherizing applications). An externally accessible jumper selects passive or active operation. An available 70.7/100 Volt transformer kit can be easily installed for use in distributed systems.

Technical Specifications:

Freq. Response ¹ (-3 dB):	60 Hz - 15 kHz	
Freq. Range ¹ (-10 dB):	50 Hz - 16 kHz	
Rec. Hipass Frequency:	60 Hz	
Axial Sensitivity:	105 dB (1W/1m)	
Max. Calculated SPL:	138 dB	
Horizontal Coverage:	90° (or 40°)	
Vertical Coverage:	40° (or 90°)	
Power Handling:	500W Continuous, 2000W Peak	
LF Transducer:	SMX2151, 15 in (381mm) Driver	
HF Transducer:	ND2B, 2 in (51mm) Diaphragm Compression Driver	
Crossover Frequency:	1300 Hz	
Nominal Impedance:	8 Ohms	
Minimum Impedance:	6.0 Ohms	
Connectors:	(2) 4 Contact 10 AWG (2.6mm) Phoenix/EuroBlock Style Screw Terminals	PI Version - Gland Nut with Included Input Panel Cover
Enclosure Material:	13 Ply Weather Resistant Birch	
Grille:	16 GA Galvanneal, Powdercoat, with Rotatable Logo	PI Version - Stainless Steel with Hydrophobic Cloth
Suspension:	(28) M10 Threaded Points	
Dimensions (H x W x D):	30.26" x 30.26" x 26.77" (768.6mm x 768.6mm x 680.1mm)	
Net Weight:	143 lbs (64.9 kg)	
Shipping Weight:	158 lbs (71.8 kg)	

¹ Half Space Measurement.



EVH-1152S/94 Loudspeaker System

Frequency Response & Impedance:

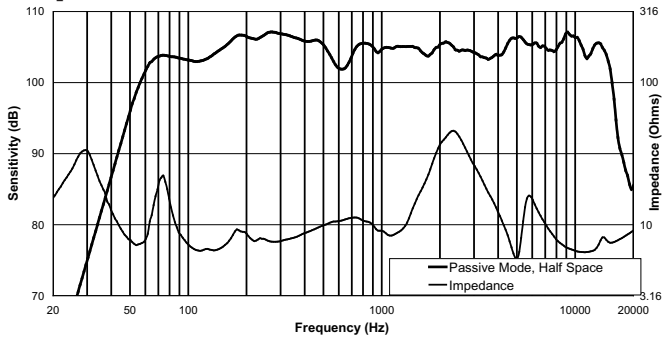

Horizontal Off Axis Frequency Response:

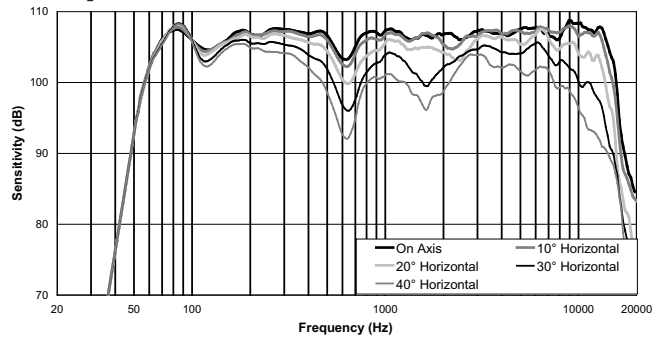

Vertical Off Axis Frequency Response:

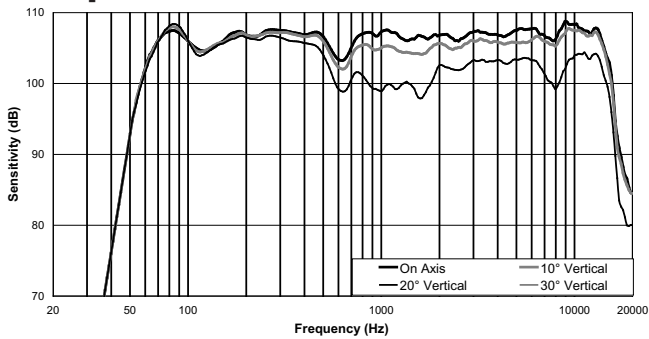

Beamwidth:

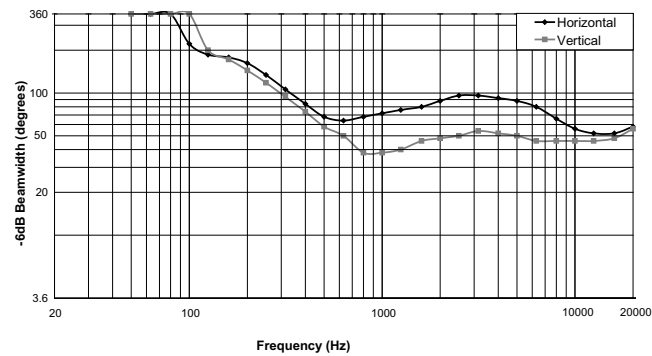

Directivity:

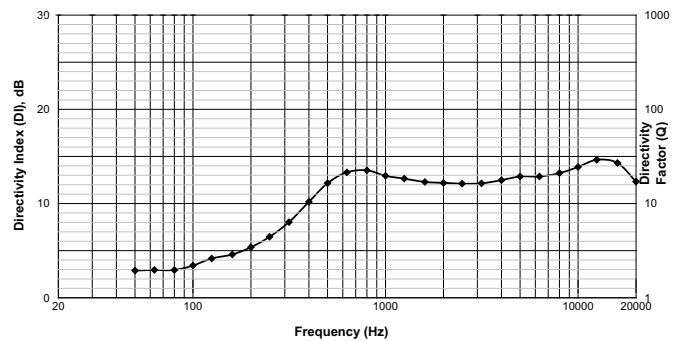

Block Diagram (Biamp):

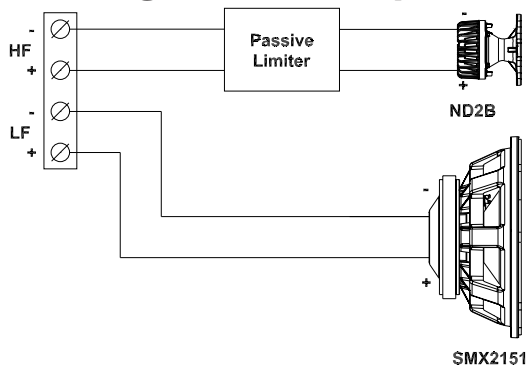

Block Diagram (Passive):

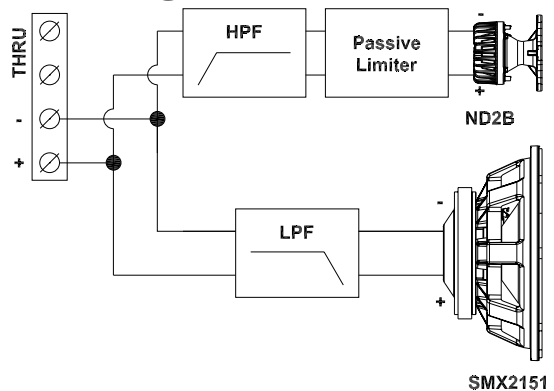

Polar Plots (1/3 Octave):

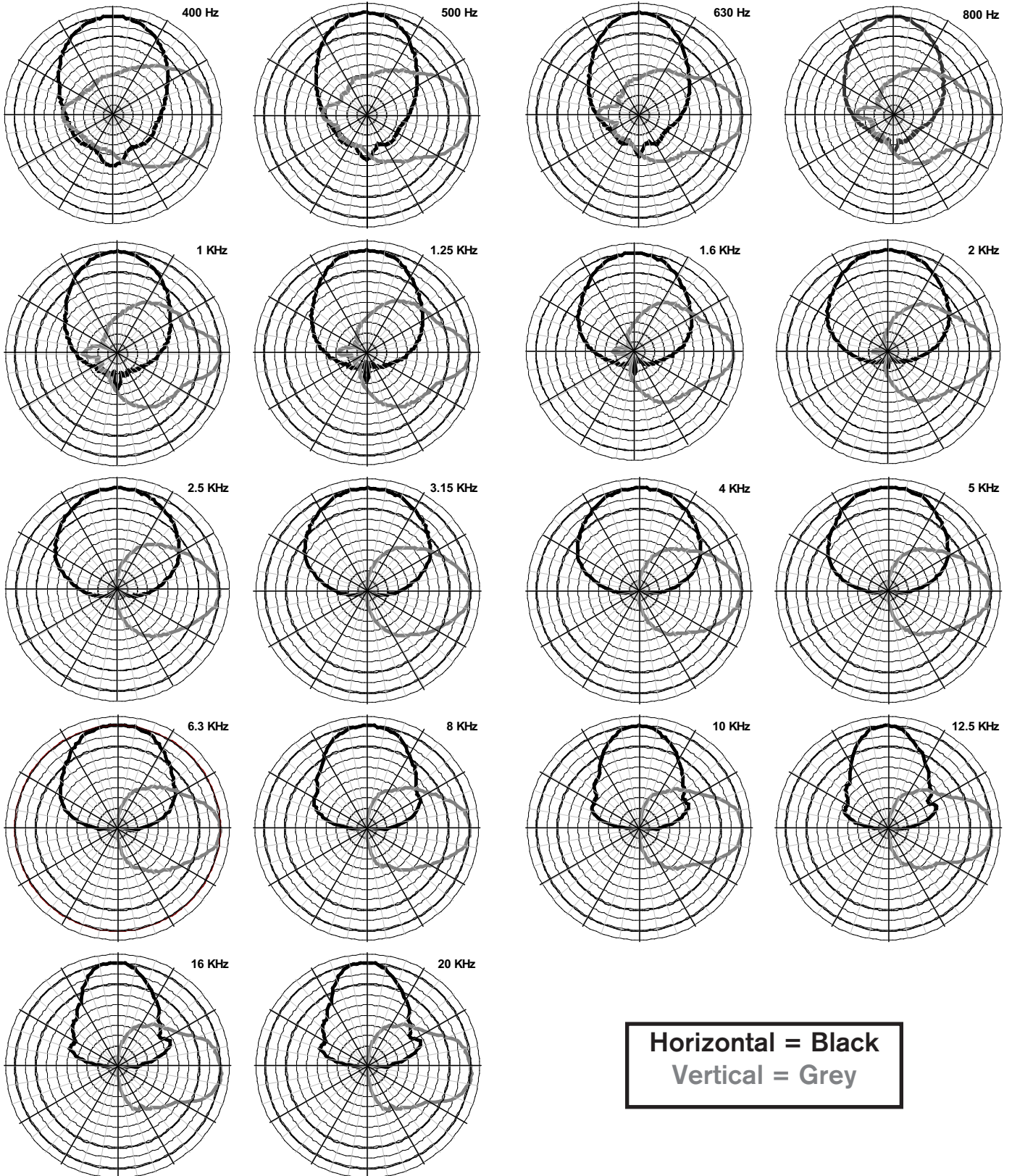

Dimension Drawings:

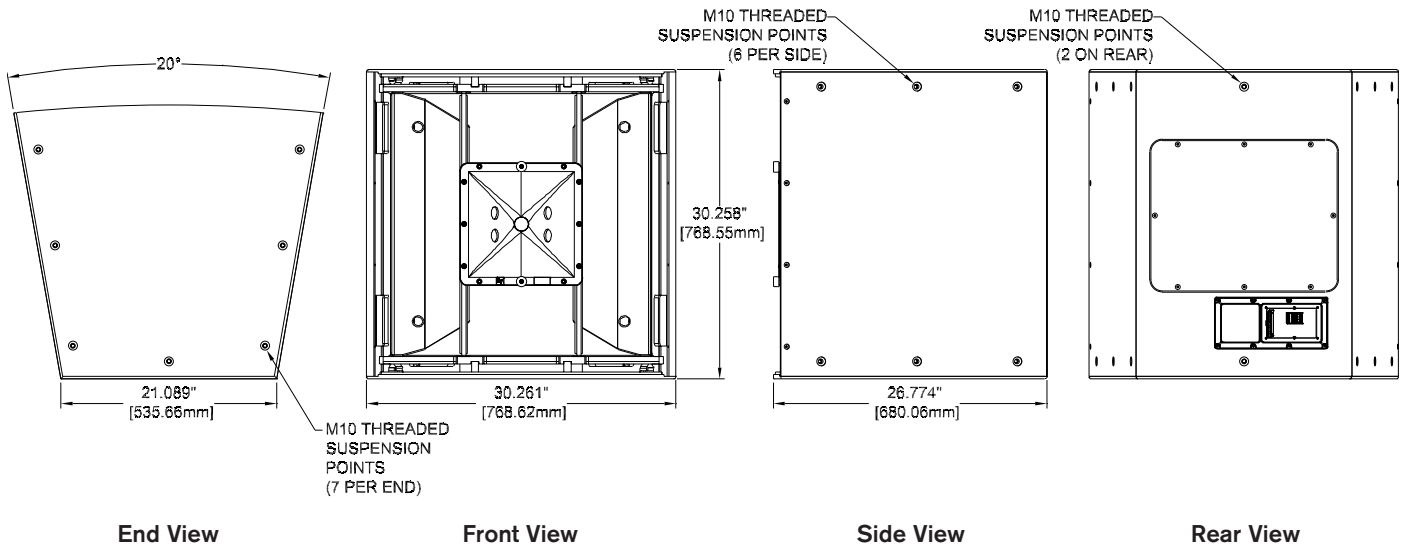

EVH-1152S/94 Part Numbers

- PRD000216-001 EVH-1152S/94-BLK, 90° x 40°, Black Finish
- PRD000216-002 EVH-1152S/94-WHT, 90° x 40°, White Finish
- PRD000216-003 EVH-1152S/94-PIB, 90° x 40°, Black Finish, Weather Resistant
- PRD000216-004 EVH-1152S/94-PIW, 90° x 40°, White Finish, Weather Resistant
- PRD000216-005 EVH-1152S/94-FGB, 90° x 40°, Black Finish, Weather Resistant Fiberglass
- PRD000216-006 EVH-1152S/94-FGW, 90° x 40°, White Finish, Weather Resistant Fiberglass



CAUTION

This EVH Loudspeaker should be suspended overhead only in accordance with the procedures and limitations specified in the *EVF/EVH Users Manual* and possible manual update notices. This system should be suspended with certified rigging hardware by an authorized rigging professional and in compliance with local, state, and federal overhead suspension ordinances.

Performance Match

- PRD000211 EVF-1121S, 12" Bass Element
- PRD000212 EVF-1151S, 15" Bass Element
- PRD000213 EVF-1181S, 18" Bass Element
- PRD000214 EVH-1152S/64, Coaxial 60° x 40° Coverage
- PRD000215 EVH-1152S/66, Coaxial 60° x 60° Coverage
- PRD000217 EVH-1152S/96, Coaxial 90° x 60° Coverage
- PRD000218 EVH-1152S/99, Coaxial 90° x 90° Coverage
- F.01U.076.843 CPS2.9, 120V Power Amplifier, 2 x 900W
- F.01U.076.844 CPS2.12, 120V Power Amplifier, 2 x 1200W
- D170469 CPS4.5, 120V Power Amplifier, 4 x 500W
- D170466 CPS4.10, 120V Power Amplifier, 4 x 1000W

Accessories

- ACC000084-000 CDNL4, Cover Plate, Dual NL4
- ACC000085-000 CSG, Cover Plate, Single Gland Nut
- ACC000086-000 CDG, Cover Plate, Dual Gland Nut
- ACC000087-000 TK-150, 70V Transformer, 150W
- ACC000089-001 HRK-1B, Horiz. Rigging Kit, EVF, Black
- ACC000089-002 HRK-1W, Horiz. Rigging Kit, EVF, White
- ACC000090-001 HRK-2B, Horiz. Rigging Kit, EVF-SUB, Black
- ACC000090-002 HRK-2W, Horiz. Rigging Kit, EVF-SUB, White
- ACC000091-001 HRK-3B, Horiz. Rigging Kit, EVH, Black
- ACC000091-002 HRK-3W, Horiz. Rigging Kit, EVH, White
- ACC000092-001 VRK-1B, Vert. Rigging Kit, EVF, Black
- ACC000092-002 VRK-1W, Vert. Rigging Kit, EVF, White
- ACC000093-001 VRK-2B, Vert. Rigging Kit, EVF-SUB, Black
- ACC000093-002 VRK-2W, Vert. Rigging Kit, EVF-SUB, White
- ACC000094-001 VRK-3B, Vert. Rigging Kit, EVH, Black
- ACC000094-002 VRK-3W, Vert. Rigging Kit, EVH, White

Electro-Voice®

12000 Portland Avenue South, Burnsville, MN 55337
 Phone: 952/884-4051, Fax: 952/884-0043

www.electrovoice.com

© Bosch Communications Systems 05/2009

Part Number LIT000281002 Rev A

U.S.A. and Canada only. For customer orders, contact Customer Service at:
800/392-3497 Fax: 800/955-6831

Europe, Africa, and Middle East only. For customer orders, contact Customer Service at:
+ 49 9421-706 0 Fax: + 49 9421-706 265

Other International locations. For customer orders, Contact Customer Service at:
+ 1 952 884-4051 Fax: + 1 952 887-9212

For warranty repair or service information, contact the Service Repair department at:
800/685-2606

For technical assistance, contact Technical Support at: **866/78AUDIO**

Specifications subject to change without notice.