

EVH-1152D/64

Single 15" Two-Way Coaxial 60° x 40° Full-Range High-Efficiency Loudspeaker System



Key Features:

- DH7N 3" (76 mm) diaphragm, 1.4" (36 mm) exit pure titanium compression driver
- SMX2151 15" (381 mm) LF transducer with fully symmetric drive
- Advanced fourth-order crossover network with HF protection
- Coverage pattern: 60° x 40° Constant Directivity™ 12" rotatable waveguide
- 105 dB sensitivity, 138 dB maximum SPL
- System rating: 500 W continuous, 2000 W peak
- Active rating: LF 400 W/HF 75 W continuous (1600 W/300 W peak)
- (28) M10 threaded suspension points
- PI and FG versions available with gland nut and stainless-steel grille

General Description:

The Electro-Voice EVH-1152D/64 is a high-power, two-way horn-loaded coaxial loudspeaker system that can be used in a variety of applications where excellent sound reinforcement, wide bandwidth directivity control, and high efficiency is required in a compact package.

The EVH-1152D/64 utilizes the DH7N, a high-output 3" titanium compression driver, coupled to a Constant Directivity™ 60° x 40° waveguide. The SMX2151 15" woofer was developed using FEA optimization for motor, suspension, and electrical design to ensure very low distortion, high efficiency, and maximum intelligibility at high SPL. The crossover uses steep, 24-dB-per-octave slopes with equalization for very smooth response in the vocal range, linear off-axis response, and a protection circuit for long-term reliability. This combination of technologies results in a smooth response to 20 kHz and excellent pattern control down to 500 Hz.

The EVH-1152D/64's features make it ideal for many fixed-install applications. The trapezoidal enclosure is constructed of weather-resistant birch, and coated with EVCoat™ for protection from the elements. For maximum protection against extreme outdoor elements, a fully-weatherized fiberglass version is available. The unique acoustic and rigging design allows for vertical and horizontal clusters to be built using any combination of loudspeakers from the entire EVF and EVH series. With seven horn patterns to choose from, along with an assortment of low-frequency and subwoofer loudspeakers, you have the tools to maximize flexibility of system design, no matter what the application and budget. The innovative input panel provides a choice of Phoenix-style connector (included in all standard models) or the ability to add a dual NL4-type connector cover plate or gland-nut cover plate (for weatherizing applications). An externally accessible jumper selects passive or active operation. An available 70.7/100-V transformer kit may be easily mounted to the input panel for use in distributed systems. All these features give you the flexibility to address a large range of venues, quickly and precisely supporting customer requirements with fewer items in inventory.

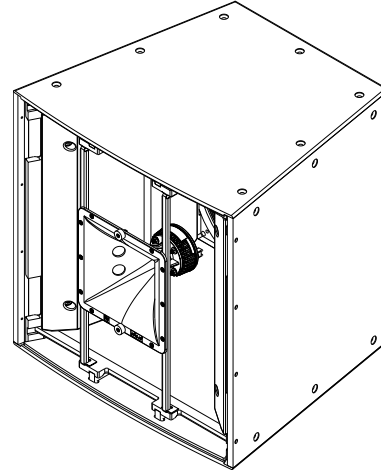

Technical Specifications:

Freq. Response ¹ (-3 dB):	60 Hz - 17 kHz	
Freq. Range ¹ (-10 dB):	50 Hz - 20 kHz	
Rotatable Coverage:	60° x 40°	
Rec. High-Pass Frequency:	60 Hz	
Passive Crossover Freq.:	1300 Hz	
Axial Sensitivity ¹ :	105 dB (1 W/1 m)	
Max. Calculated SPL ¹ :	138 dB	
Passive Power Handling ² :	500 W continuous, 2000 W peak	
Impedance:	8 ohms (nominal), 6.0 ohms (min.)	
LF Transducer - SMX2151, 15" (381 mm) driver		
LF Axial Sensitivity ⁴ :	106 dB (1 W/1 m)	
LF Max. Calculated SPL:	138 dB	
LF Power Handling ³ :	400 W continuous, 1600 W peak	
LF Impedance:	8 ohms (nominal), 6.1 ohms (min.)	
HF Transducer - DH7N, 3" (76 mm) diaphragm compression driver		
HF Axial Sensitivity ⁴ :	113 dB (1 W/1 m)	
HF Max. Calculated SPL:	138 dB	
HF Power Handling ³ :	75 W continuous, 300 W peak	
HF Impedance:	8 ohms (nominal), 6.0 ohms (min.)	
Connectors:	Dual four-pin 10 AWG Phoenix/Euro Block screw-terminals	PI/FG Versions - CDG dual-gland-nut input panel cover included
Enclosure:	13-ply weather-resistant birch with EVCoat™	FG Version - 13-ply weather-resistant birch with fiberglass finish
Grille:	16 GA powder-coated galvanized with rotatable logo	PI/FG Versions - Stainless steel with hydrophobic cloth
Environmental:	IEC 60529 IP55 for PI and FG versions	
Suspension:	(28) M10 threaded suspension points	
Dimensions (H x W x D):	30.26" x 30.26" x 26.77" (768.6 mm x 768.6 mm x 680.1 mm)	
Weight:	145.5 lb (66.1 kg) net, 160.5 lb (72.9 kg) shipping	

¹ Half-space measurement.

² EIA RS-426A, tested for eight hours.

³ AES 2-1984, tested for eight hours.

⁴ Arithmetic averages, 300 - 1,300 Hz (LF) and 1,300 - 5,000 Hz (HF).



EVH-1152D/64 Loudspeaker System

Frequency Response & Impedance:

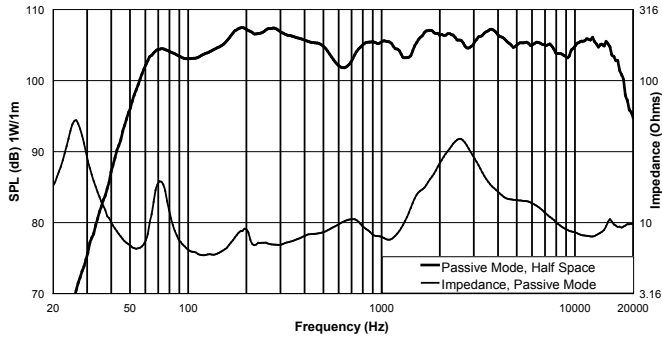

Horizontal Off-Axis Frequency Response:

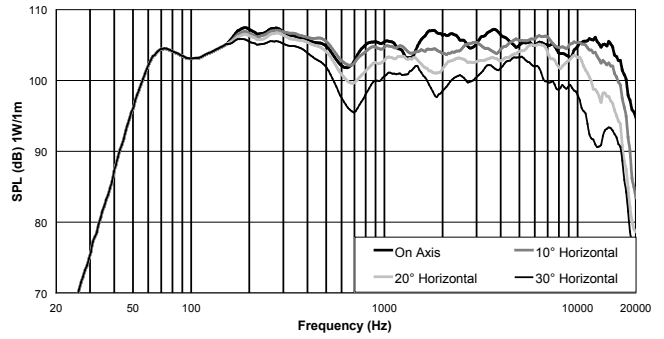

Vertical Off-Axis Frequency Response:

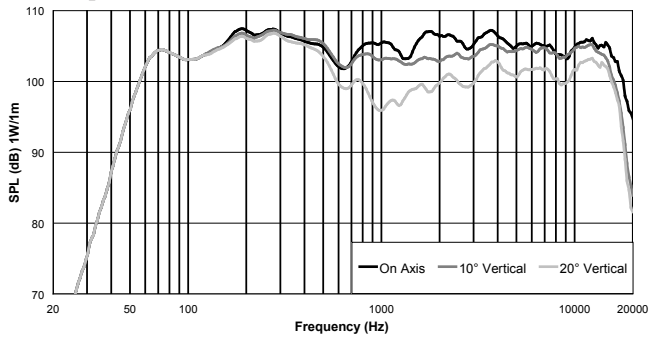

Beamwidth:

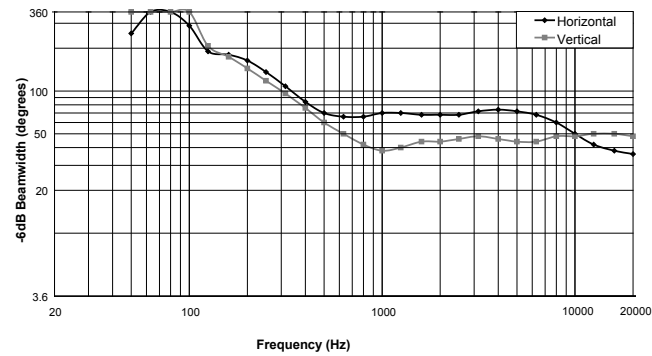

Directivity:

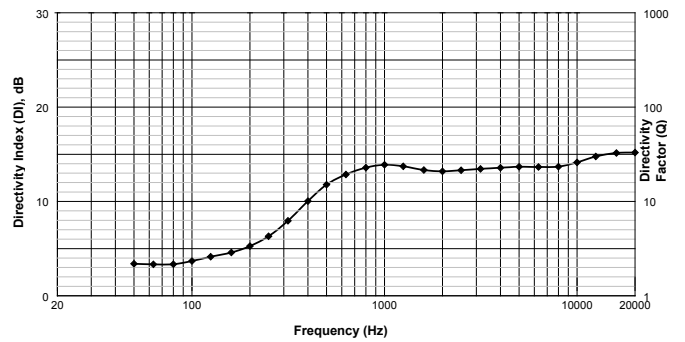

Block Diagram (biamp):

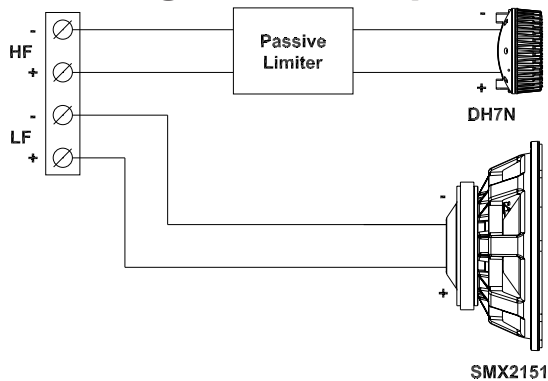

Block Diagram (passive):

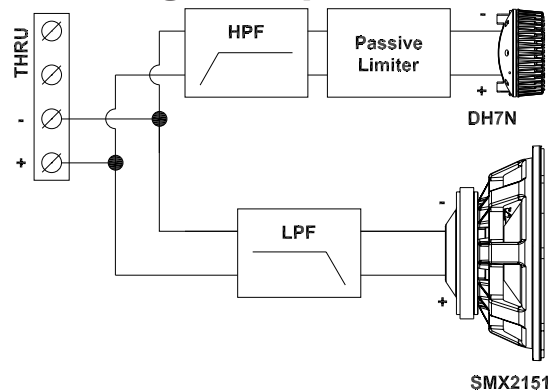

Polar Plots (1/3 Octave):

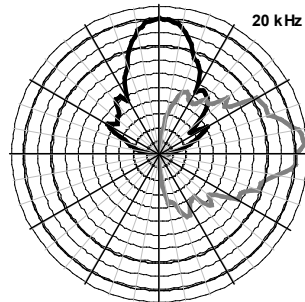
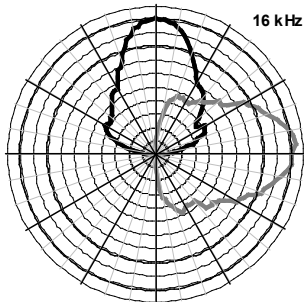
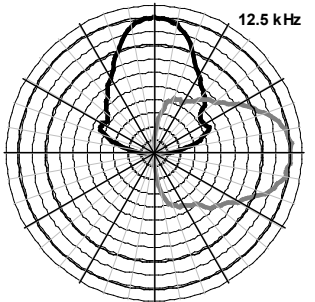
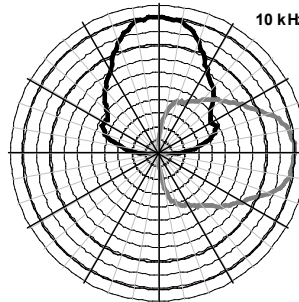
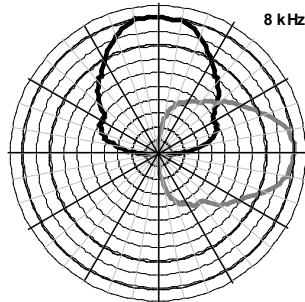
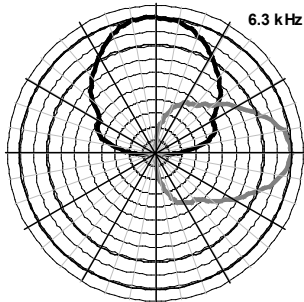
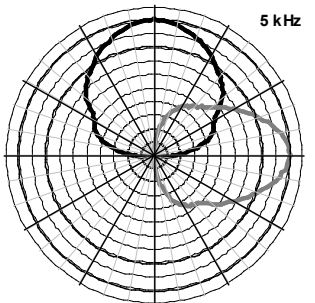
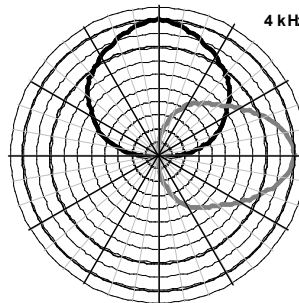
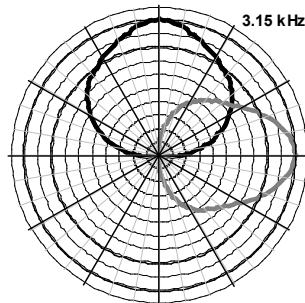
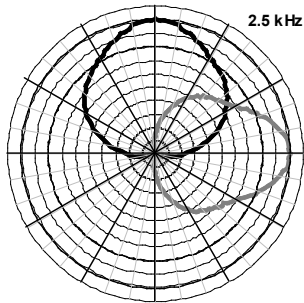
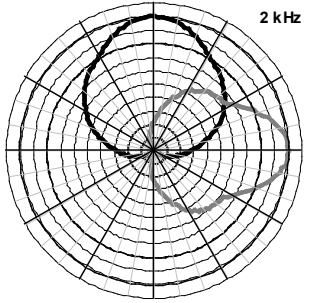
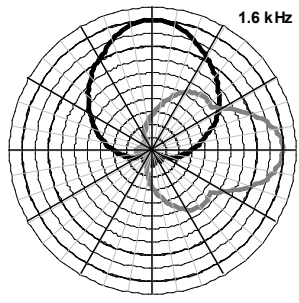
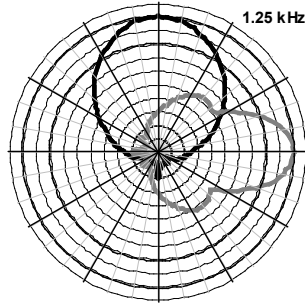
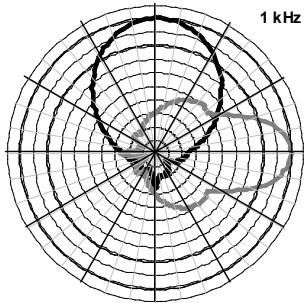
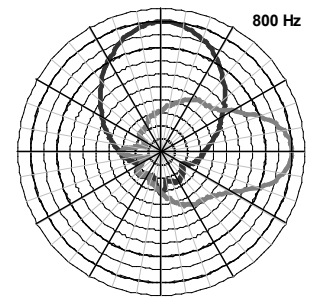
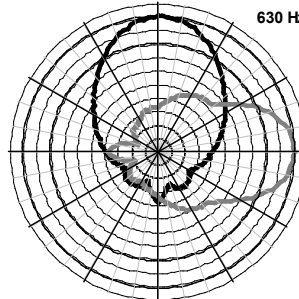
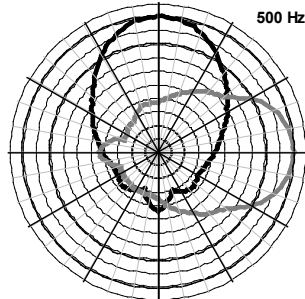
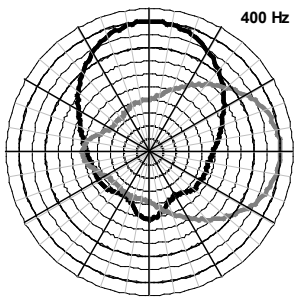

Horizontal = Black
Vertical = Grey

Dimension Drawings:

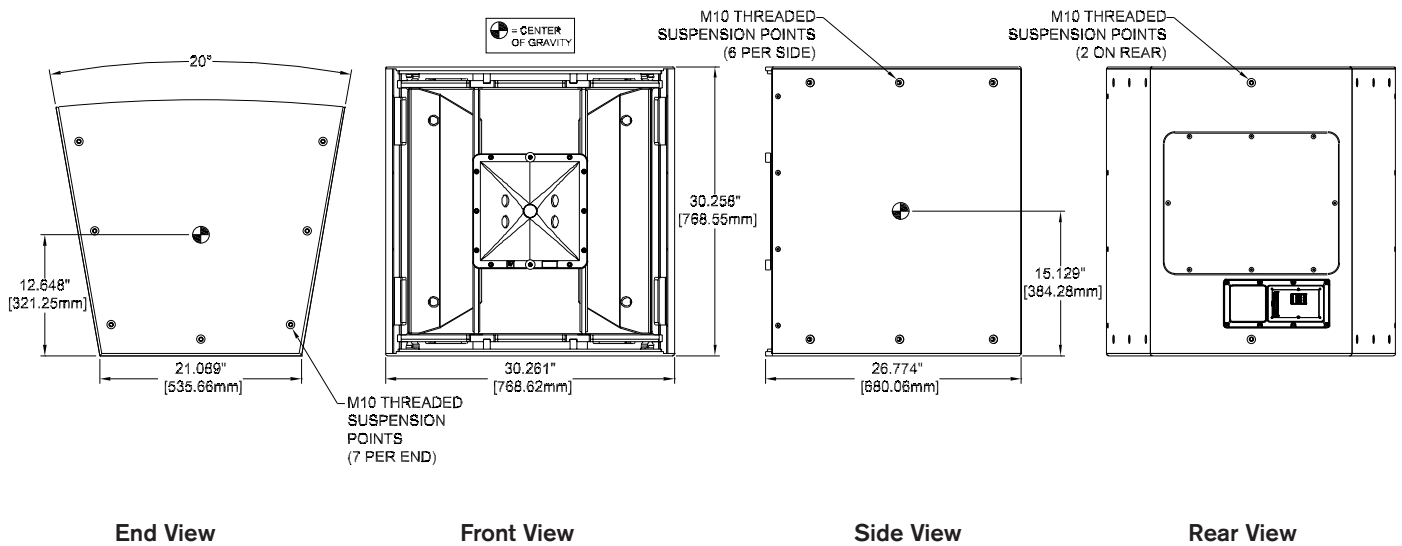

EVH-1152D/64 Part Numbers

- PRD000304-001 EVH-1152D/64-BLK, 60° x 40°, black finish
- PRD000304-002 EVH-1152D/64-WHT, 60° x 40°, white finish
- PRD000304-003 EVH-1152D/64-PIB, 60° x 40°, black finish, weather resistant
- PRD000304-004 EVH-1152D/64-PIW, 60° x 40°, white finish, weather resistant
- PRD000304-005 EVH-1152D/64-FGB, 60° x 40°, black finish, weather resistant fiberglass
- PRD000304-006 EVH-1152D/64-FGW, 60° x 40°, white finish, weather resistant fiberglass

⚠ CAUTION ⚠

This EVH loudspeaker should be suspended overhead only in accordance with the procedures and limitations specified in the *EVF/EVH User Manual* and possible manual update notices. This system should be suspended with certified rigging hardware by an authorized rigging professional and in compliance with local, state, and federal overhead suspension ordinances.

Performance Match

- PRD000303 EVH-1152D/43, 40° x 30° coverage
- PRD000305 EVH-1152D/66, 60° x 60° coverage
- PRD000306 EVH-1152D/94, 90° x 40° coverage
- PRD000307 EVH-1152D/96, 90° x 60° coverage
- PRD000308 EVH-1152D/99, 90° x 90° coverage
- PRD000300 EVF-2121S, dual 12" bass element
- PRD000302 EVF-2151D, dual 15" bass element
- CPS2.9 120V CPS2.9, 120V power amplifier, 2 x 900W
- CPS2.12 120V CPS2.12, 120V power amplifier, 2 x 1200W
- D170469 CPS4.5, 120V power amplifier, 4 x 500W
- D170466 CPS4.10, 120V power amplifier, 4 x 1000W

Accessories

- ACC000084-000 CDNL4, cover plate, dual NL4
- ACC000085-000 CSG, cover plate, single gland nut
- ACC000086-000 CDG, cover plate, dual gland nut
- ACC000087-000 TK-150, 70V transformer, 150W
- ACC000089-001 HRK-1B, horiz. rigging kit, EVF, black
- ACC000089-002 HRK-1W, horiz. rigging kit, EVF, white
- ACC000090-001 HRK-2B, horiz. rigging kit, EVF-SUB, black
- ACC000090-002 HRK-2W, horiz. rigging kit, EVF-SUB, white
- ACC000091-001 HRK-3B, horiz. rigging kit, EVH, black
- ACC000091-002 HRK-3W, horiz. rigging kit, EVH, white
- ACC000092-001 VRK-1B, vert. rigging kit, EVF, black
- ACC000092-002 VRK-1W, vert. rigging kit, EVF, white
- ACC000093-001 VRK-2B, vert. rigging kit, EVF-SUB, black
- ACC000093-002 VRK-2W, vert. rigging kit, EVF-SUB, white
- ACC000094-001 VRK-3B, vert. rigging kit, EVH, black
- ACC000094-002 VRK-3W, vert. rigging kit, EVH, white

Electro-Voice

12000 Portland Avenue South, Burnsville, MN 55337
 Phone: 952/884-4051, Fax: 952/884-0043

www.electrovoice.com

© Bosch Communications Systems 07/2010
Part Number LIT000467064 Rev A

U.S.A. and Canada only. For customer orders, contact Customer Service at:
800/392-3497 Fax: 800/955-6831

Europe, Africa, and Middle East only. For customer orders, contact Customer Service at:
+ 49 9421-706 0 Fax: + 49 9421-706 265

Other International locations. For customer orders, Contact Customer Service at:
+ 1 952 884-4051 Fax: + 1 952 887-9212

For warranty repair or service information, contact the Service Repair department at:
800/685-2606

For technical assistance, contact Technical Support at: **866/78AUDIO**

Specifications subject to change without notice.