



# ASSEMBLY INSTRUCTION

## NL4FX / NL4FRX

### speakON® SPX Series | Lockable Loudspeaker Connector

#### IMPORTANT SAFETY INSTRUCTION

Electrical Rating acc. UL & CSA:  
USR: 40A/250V, CNR: 25A/250V

“CAUTION: NOT FOR INTERRUPTING CURRENT”  
“ATTENTION: NE PAS UTILISER POUR COUPER LE COURANT”

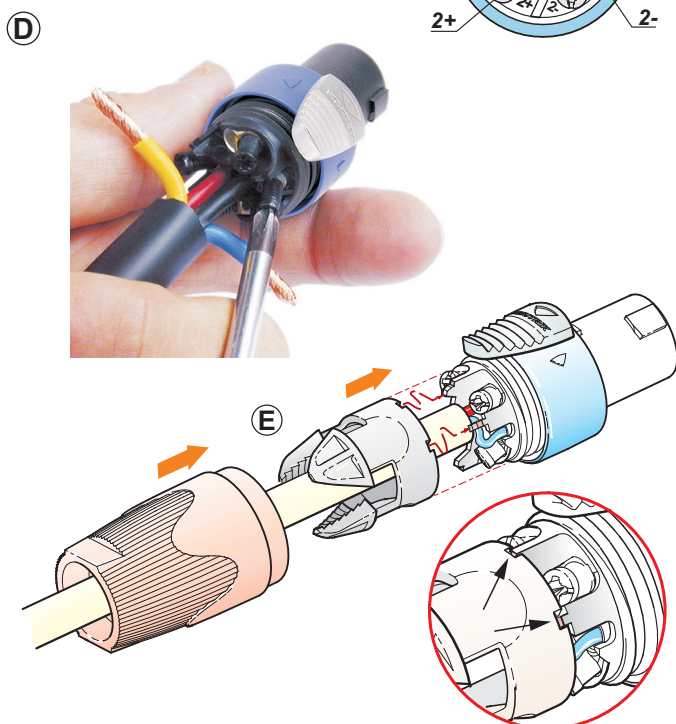
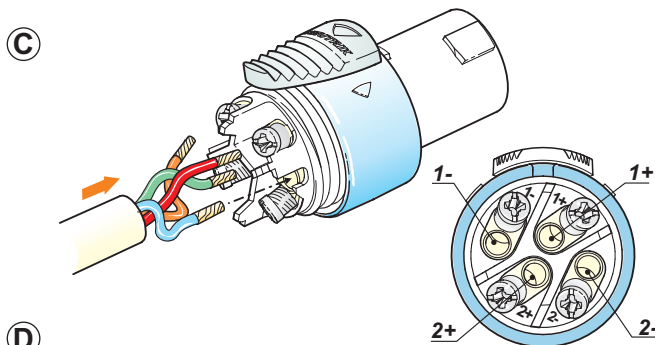
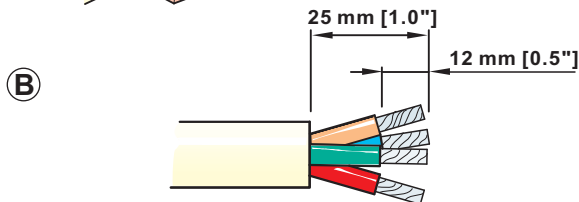
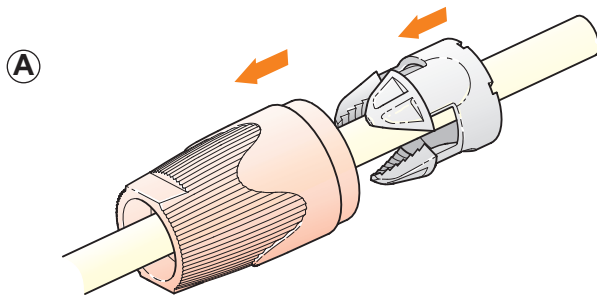

#### Assembly of the Connector:

- A Place bushing and chuck over cable.
- B Prepare cable as shown.  
Important is the stripping length of 25 mm and 12 mm.
- C Insert wires into terminals and secure clamp terminals with screw driver (Pozidrive®).
- D For easy wiring especially on big cables, first screw on the inner contacts 1+ and 2+ and afterwards the outer contacts 1- and 2- !
- E Push chuck up to housing .  
**Important:** Align the chuck by positioning the nose into the recess.
- F Tighten the bushing

#### INFO to the screw driver:

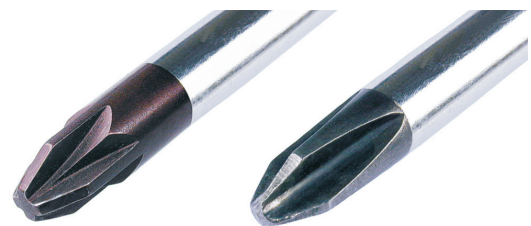

**DO NOT USE!**

Pozidrive #1

Philips

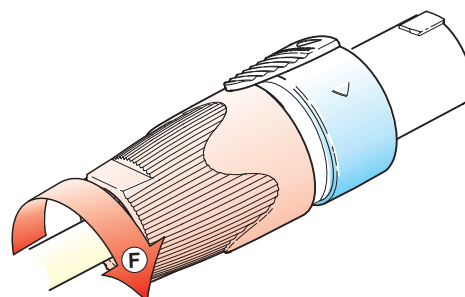



### Assembly of the Conversion Kit:

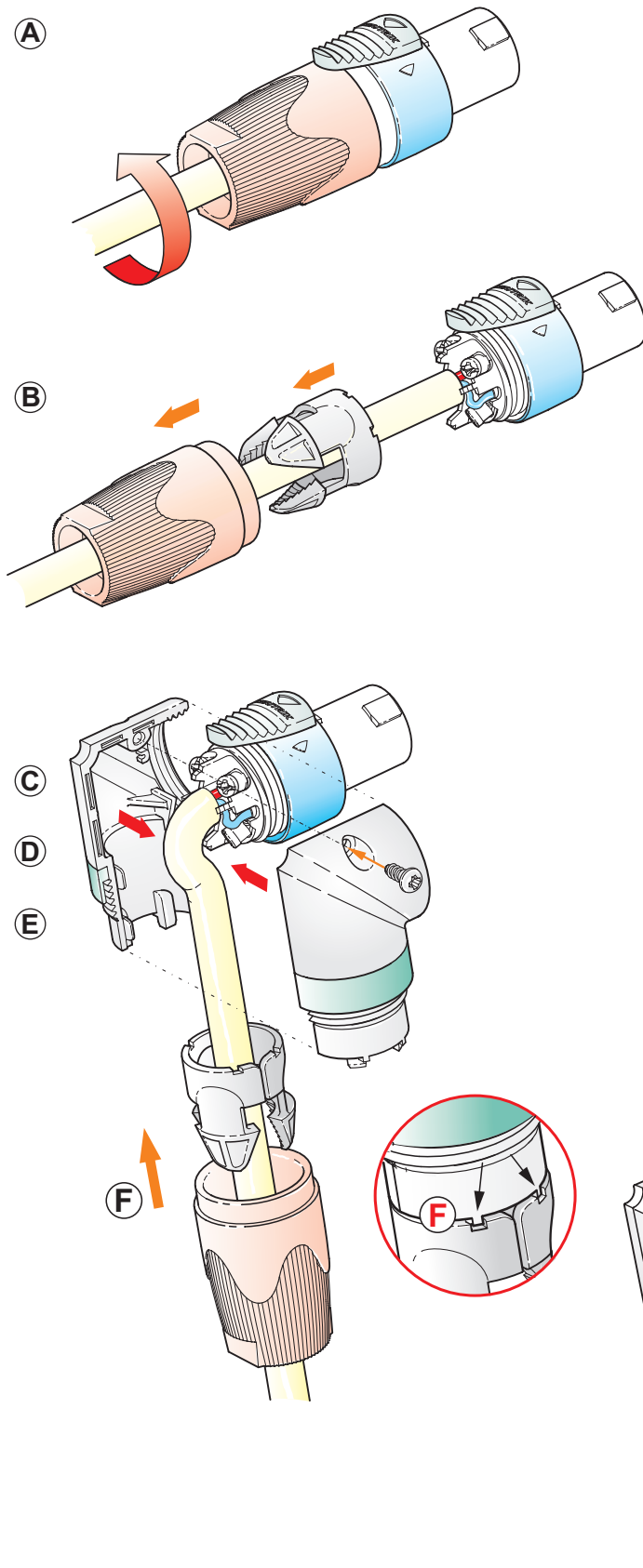

- A** Open the bushing.
- B** Slide the bushing and the chuck back.
- C** Bend the cable as shown.
- D** Position the two conversion shells to fit on the connector thread.
- E** Press together and fix by screw.
- F** Slide the chuck onto the housing and fasten the bushing.  
**Important:** Align the chuck by positioning the nose into the recess.

### Handling:

Engagement:

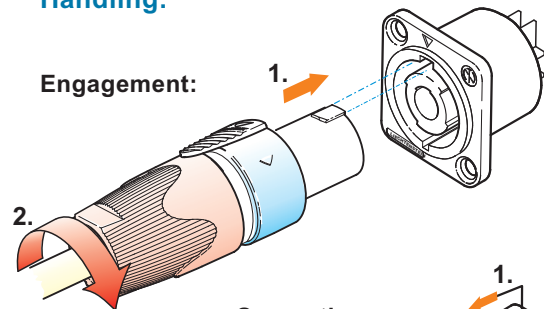

Separation:

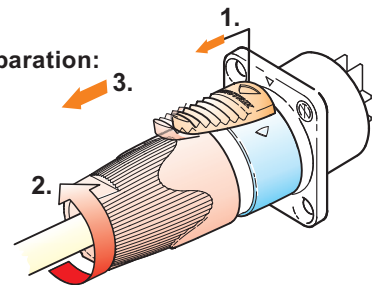

NEUTRIK AG LI T: +423 / 237 24 24 F: +423 / 232 53 93  
 NEUTRIK USA Inc. USA T: +1 732 / 901 9488 F: +1 732 / 901 9608  
 NEUTRIK (UK) Ltd. UK T: +44 1983 / 811 441 F: +44 1983 / 811 439  
 NEUTRIK Vertriebs GmbH DE/NL/AT/DK T: +49 8131 / 280 890 F: +49 8131 / 280 830

NEUTRIK France FR T: +33 1 / 4131 6750 F: +33 1 / 4131 0511  
 NEUTRIK Tokyo Ltd. JP T: +81 3 / 3663 4733 F: +81 3 / 3663 4796  
 NEUTRIK Hong Kong Ltd. HK T: +852 / 2687 6055 F: +852 / 2687 6052