



## **PRO2 Live Audio System**

### **Owner's Manual**

MUSIC Group Research UK Limited,  
Klark Industrial Park,  
Walter Nash Road,  
Kidderminster.  
Worcestershire.  
DY11 7HJ.  
England.

Tel: +44 1562 741515  
Fax: +44 1562 745371

Email: [mkt.info@music-group.com](mailto:mkt.info@music-group.com)  
Website: [www.midasconsoles.com](http://www.midasconsoles.com)

PRO2 Live Audio System — Owner's Manual  
DOC02-DL2 Issue A — October 2011  
© MUSIC Group IP Limited

© 2011 MUSIC Group IP Ltd. Technical specifications and appearances are subject to change without notice and accuracy is not guaranteed. MIDAS and KLARK TEKNIK are part of the MUSIC Group ([music-group.com](http://music-group.com)).





**EN** Important safety instructions

Terminals marked with this symbol carry electrical current of sufficient magnitude to constitute risk of electric shock. Use only high-quality commercially-available speaker cables with ¼" TS plugs pre-installed. All other installation or modification should be performed only by qualified personnel.



This symbol, wherever it appears, alerts you to the presence of uninsulated dangerous voltage inside the enclosure - voltage that may be sufficient to constitute a risk of shock.



This symbol, wherever it appears, alerts you to important operating and maintenance instructions in the accompanying literature. Please read the manual.



**Caution**  
To reduce the risk of electric shock, do not remove the top cover (or the rear section). No user serviceable parts inside. Refer servicing to qualified personnel.



**Caution**  
To reduce the risk of fire or electric shock, do not expose this appliance to rain and moisture. The apparatus shall not be exposed to dripping or splashing liquids and no objects filled with liquids, such as vases, shall be placed on the apparatus.



**Caution**  
These service instructions are for use by qualified service personnel only. To reduce the risk of electric shock do not perform any servicing other than that contained in the operation instructions. Repairs have to be performed by qualified service personnel.

- 1 Read these instructions.
- 2 Keep these instructions.
- 3 Heed all warnings.
- 4 Follow all instructions.
- 5 Do not use this apparatus near water.
- 6 Clean only with dry cloth.
- 7 Do not block any ventilation openings. Install in accordance with the manufacturer's instructions.
- 8 Do not install near any heat sources such as radiators, heat registers, stoves, or other apparatus (including amplifiers) that produce heat.

9 Do not defeat the safety purpose of the polarized or grounding-type plug. A polarized plug has two blades with one wider than the other. A grounding-type plug has two blades and a third grounding prong. The wide blade or the third prong are provided for your safety. If the provided plug does not fit into your outlet, consult an electrician for replacement of the obsolete outlet.

10 Protect the power cord from being walked on or pinched particularly at plugs, convenience receptacles, and the point where they exit from the apparatus.

11 Use only attachments/accessories specified by the manufacturer.



12 Use only with the cart, stand, tripod, bracket, or table specified by the manufacturer, or sold with the apparatus. When a cart is used, use caution when moving the cart/apparatus combination to avoid injury from tip-over.

13 Unplug this apparatus during lightning storms or when unused for long periods of time.

14 Refer all servicing to qualified service personnel. Servicing is required when the apparatus has been damaged in any way, such as power supply cord or plug is damaged, liquid has been spilled or objects have fallen into the apparatus, the apparatus has been exposed to rain or moisture, does not operate normally, or has been dropped.

15 The apparatus shall be connected to a MAINS socket outlet with a protective earthing connection.

16 Where the MAINS plug or an appliance coupler is used as the disconnect device, the disconnect device shall remain readily operable.



## Legal disclaimer

Technical specifications and appearances are subject to change without notice and accuracy is not guaranteed. MIDAS and KLARK TEKNIK are part of the MUSIC Group (music-group.com). All trademarks are the property of their respective owners. MUSIC Group accepts no liability for any loss which may be suffered by any person who relies either wholly or in part upon any description, photograph or statement contained herein. Colours and specifications may vary slightly from product. Midas products are sold through authorized dealers only. Distributors and dealers are not agents of MUSIC Group and have absolutely no authority to bind MUSIC Group by

any express or implied undertaking or representation. This manual is copyrighted. No part of this manual may be reproduced or transmitted in any form or by any means, electronic or mechanical, including photocopying and recording of any kind, for any purpose, without the express written permission of MUSIC Group IP Limited

ALL RIGHTS RESERVED.

© 2011 MUSIC Group IP Limited  
Trident Chambers, Wickhams Cay, P.O. Box 146,  
Road Town, Tortola, British Virgin Islands

## Limited warranty

### § 1 Warranty

7. This limited warranty is valid only if you purchased the product from a MUSIC Group authorized dealer in the country of purchase. A list of authorized dealers can be found on MUSIC Group's website [www.midasconsoles.com](http://www.midasconsoles.com), or you can contact the MUSIC Group office closest to you.

2. MUSIC Group\* warrants the mechanical and electronic components of this product to be free of defects in material and workmanship if used under normal operating conditions for a period of three (3) years from the original date of purchase (see the Limited Warranty terms in § 4 below), unless a longer minimum warranty period is mandated by applicable local laws. If the product shows any defects within the specified warranty period and that defect is not excluded under § 4, MUSIC Group shall, at its discretion, either replace or repair the product using suitable new or reconditioned product or parts. In case MUSIC Group decides to replace the entire product, this limited warranty shall apply to the replacement product for the remaining initial warranty period, i.e., three (3) years (or otherwise applicable minimum warranty period) from the date of purchase of the original product.

3. Upon validation of the warranty claim, the repaired or replacement product will be returned to the user freight prepaid by MUSIC Group.

4. Warranty claims other than those indicated above are expressly excluded.

PLEASE RETAIN YOUR SALES RECEIPT. IT IS YOUR PROOF OF PURCHASE COVERING YOUR LIMITED WARRANTY. THIS LIMITED WARRANTY IS VOID WITHOUT SUCH PROOF OF PURCHASE.

### § 2 Online registration

Please do remember to register your new Midas equipment right after your purchase at [www.midasconsoles.com](http://www.midasconsoles.com) and kindly read the terms and conditions of our limited warranty carefully. Registering your purchase and equipment with us helps us process your repair claims quicker and more efficiently. Thank you for your cooperation!

### § 3 Return materials authorization

1. To obtain warranty service, please contact the retailer from whom the equipment was purchased. Should your MUSIC Group dealer not be located in your vicinity, you may contact the MUSIC Group distributor for your country listed at [www.midasconsoles.com](http://www.midasconsoles.com). If your country is not listed please contact the "United Kingdom (Midas/ KT main office)" located under "Service ↳ Service/Repairs" on the [www.midasconsoles.com](http://www.midasconsoles.com) website. Alternatively, please submit the online warranty return form found under "Service ↳ Warranty Registration" on [www.midasconsoles.com](http://www.midasconsoles.com) BEFORE returning the product. All enquires must be accompanied by the description of the problem and the serial number of the product. The warranty eligibility will be verified from the original sales receipt.
2. Subsequently, the product must be returned in its original shipping carton, together with the return authorization number to the address indicated by MUSIC Group.
3. Shipments without freight prepaid will not be accepted.

### § 4 Warranty Exclusions

1. This limited warranty does not cover consumable parts including, but not limited to, fuses and batteries. Where applicable, MUSIC Group warrants the valves or meters contained in the product to be free from defects in material and workmanship for a period of ninety (90) days from date of purchase.
2. This limited warranty does not cover the product if it has been electronically or mechanically modified in any way. If the product needs to be modified or adapted in order to comply with applicable technical or safety standards on a national or local level, in any country which is not the country for which the product was originally developed and manufactured, this modification/adaptation shall not be considered a defect in materials or workmanship. This limited warranty does not cover any such modification/adaptation, regardless of whether it was carried out properly or not. Under the terms of this limited warranty, MUSIC Group shall not be held responsible for any cost resulting from such a modification/ adaptation.
3. This limited warranty covers only the product hardware. It does not cover technical assistance for hardware or software usage and it does not cover any software products whether or not contained in the product. Any such software is provided "AS IS" unless expressly provided for in any enclosed software limited warranty.
4. This limited warranty is invalid if the factory-applied serial number has been altered or removed from the product.
5. Free inspections and maintenance/repair work are expressly excluded from this limited warranty, in particular, if caused by improper handling of the product by the user. This also

applies to defects caused by normal wear and tear, in particular, of faders, crossfaders, potentiometers, keys/buttons, guitar strings, illuminants and similar parts.

6. Damage/defects caused by the following conditions are not covered by this limited warranty:
  - improper handling, neglect or failure to operate the unit in compliance with the instructions given in Midas user or service manuals;
  - connection or operation of the unit in any way that does not comply with the technical or safety regulations applicable in the country where the product is used;
  - damage/defects caused by acts of God/ Nature (accident, fire, flood, etc) or any other condition that is beyond the control of MUSIC Group.
7. Any repair or opening of the unit carried out by unauthorised personnel (user included) will void the limited warranty.
8. If an inspection of the product by MUSIC Group shows that the defect in question is not covered by the limited warranty, the inspection costs are payable by the customer.
9. Products which do not meet the terms of this limited warranty will be repaired exclusively at the buyer's expense. MUSIC Group or its authorized service centre will inform the buyer of any such circumstance. If the buyer fails to submit a written repair order within 6 weeks after notification, MUSIC Group will return the unit C.O.D. with a separate invoice for freight and packing. Such costs will also be invoiced separately when the buyer has sent in a written repair order.
10. Authorized MUSIC Group dealers do not sell new products directly in online auctions. Purchases made through an online auction are on a "buyer beware" basis. Online auction confirmations or sales receipts are not accepted for warranty verification and MUSIC Group will not repair or replace any product purchased through an online auction.

### § 5 Warranty transferability

This limited warranty is extended exclusively to the original buyer (customer of authorized retail dealer) and is not transferable to anyone who may subsequently purchase this product. No other person (retail dealer, etc.) shall be entitled to give any warranty promise on behalf of MUSIC Group.

### § 6 Claim for damage

Subject only to the operation of mandatory applicable local laws, MUSIC Group shall have no liability to the buyer under this warranty for any consequential or indirect loss or damage of any kind. In no event shall the liability of MUSIC Group under this limited warranty exceed the invoiced value of the product.

### § 7 Limitation of liability

This limited warranty is the complete and exclusive warranty between you and MUSIC Group. It supersedes all other written or oral communications related to this product. MUSIC Group provides no other warranties for this product.

### § 8 Other warranty rights and national law

1. This limited warranty does not exclude or limit the buyer's statutory rights as a consumer in any way.
2. The limited warranty regulations mentioned herein are applicable unless they constitute an infringement of applicable mandatory local laws.
3. This warranty does not detract from the seller's obligations in regard to any lack of conformity of the product and any hidden defect.

### § 9 Amendment

Warranty service conditions are subject to change without notice. For the latest warranty terms and conditions and additional information regarding MUSIC Group's limited warranty, please see complete details online at [www.midasconsoles.com](http://www.midasconsoles.com).

\* MUSIC Group Macao Commercial Offshore Limited of Rue de Pequin No. 202-A, Macau Finance Centre 9/J, Macau, including all MUSIC Group companies



# Licences

The following are the license agreements applicable to the Midas Digital Equipment.

## End-User Licence Agreement for Midas™ and Klark Teknik™ Software

**IMPORTANT** - Please read this document carefully before using this Midas™ or Klark Teknik™ Product. This is an agreement governing your use of software or other machine instructions already installed on this Midas™ or Klark Teknik™ Product, as well as other software that we provide for installation on this Product. The Midas™ or Klark Teknik™ Product will not operate in accordance with its documentation without this software.

THIS AGREEMENT ("AGREEMENT" OR "LICENCE") STATES THE TERMS AND CONDITIONS UPON WHICH MIDAS KLARK TEKNIK LIMITED ("COMPANY") OFFERS TO LICENSE THE INSTALLED FIRMWARE, SOFTWARE AND/OR PROGRAMS ("the SOFTWARE") WITH THE MIDAS™ OR KLARK TEKNIK™ CONSOLE OR SIGNAL PROCESSING PRODUCT ("PRODUCT") IN WHICH IT HAS BEEN INSTALLED BY, OR FOR WHICH IT IS PROVIDED BY, THE COMPANY. BY USING THIS PRODUCT YOU WILL BE AGREEING TO BECOME BOUND BY THE TERMS OF THIS LICENCE. IF YOU DO NOT AGREE TO THE TERMS OF THIS LICENCE, DO NOT USE THIS PRODUCT AND PROMPTLY RETURN THE PRODUCT TO THE PLACE WHERE YOU OBTAINED IT FOR A FULL REFUND. You agree to notify any persons whom you permit to operate this Product of the terms of this Licence, and to require them to comply with these terms.

The Software is licensed, not sold, to you for use only under the terms of this Licence, and the Company reserves all rights not expressly granted to you. The Company retains ownership of all copies of the Software itself, and all proprietary parts of it, including those stored on or in the Product.

1. **Licence:** Subject to the terms and conditions of this agreement, the Company grants you, and other persons you permit to operate the Product, a personal, limited, non-exclusive, non-transferable licence to use the Software only on the single Product unit in which it has been installed.
2. **Restrictions:** (a) The Software, and the accompanying written materials, are copyrighted and contain trade secrets and other proprietary matter, including confidential information relating to the specifications and performance characteristics of this Product. Save for such elements as may be licensed to the Company, as described in paragraph 5, all rights to copyrights, trade marks and trade secrets in the Software, or any modifications to it, are owned by the Company. Unauthorised use or copying of the Company's proprietary Software, or any portion thereof, or copying of those written materials, is prohibited. (b) You may not create, market, distribute, or transfer copies of the Company's proprietary Software, or any part of it, to others, or duplicate, rent, lease or loan that Software, or any part of it, except that you may transfer that Software installed in this Product in conjunction with the sale, transfer, loan, rent or lease of this Product, and subject at all times to this Licence. YOU MAY NOT REVERSE ENGINEER, DECOMPILE, DISASSEMBLE, EXTRACT OR SEPARATE OUT, MODIFY, ADAPT, PORT, OR TRANSLATE THE SOFTWARE, DERIVE THE SOURCE CODE OF THE SOFTWARE OR CREATE DERIVATIVE WORKS BASED ON THE SOFTWARE OR ANY ACCOMPANYING WRITTEN MATERIALS, save as is allowed by licences pertaining to component parts of the Software which are licensed by third parties, as described under paragraph 5, or otherwise by law. (c) In the event you violate any term of this Licence, all rights granted herein will automatically and immediately terminate and you must stop using the Software and destroy any copies of the Software.
3. **Limited Warranty:** Subject to your installation of any Software updates issued by the Company as described herein, and the condition below, the Company warrants that the Software will operate in compliance with the Software's material specifications and documentation for a period of 90 days from your purchase of this Product. The Software is provided "as is" and the Company does not warrant that the operation of the Software will meet your requirements or operate free from error. To the greatest extent permissible by law, the Company DISCLAIMS ALL WARRANTIES AND CONDITIONS, EITHER EXPRESS OR IMPLIED, INCLUDING THE WARRANTIES OF MERCHANTABILITY, FITNESS FOR A PARTICULAR PURPOSE, NON-INFRINGEMENT OF THIRD PARTY RIGHTS OR CAPABILITY OF CORRECTLY PROCESSING PROVIDING AND/OR RECEIVING

DATE INFORMATION. You understand that the Company may update or revise the Software but in so doing incurs no obligation to furnish such updates to you. However, the Company may in its discretion make updates available from time to time upon such terms and conditions as it shall determine. It is a condition of the above warranty that you install any such Software updates, as may be issued from time to time by the Company for the Software, in accordance with the Company's instructions, and if you do not do so such warranty will cease to apply. You may view current Software updates at <http://www.klarktechnik.com> and <http://www.midasconsoles.com>.

4. **Limited Liability:** THE ENTIRE RISK ARISING OUT OF YOUR USE OR PERFORMANCE OF THE SOFTWARE REMAINS WITH YOU. THE LIABILITY OF THE COMPANY FOR ANY CLAIMS ARISING OUT OF THIS LICENCE AND/OR BASED UPON THE SOFTWARE, REGARDLESS OF THE FORM OF ACTION, AND INCLUDING WORK STOPPAGE, PRODUCT FAILURE OF MALFUNCTION OR ANY OTHER COMMERCIAL LOSS OR DAMAGE, SHALL NOT EXCEED THE COST OF THE LICENCE FEE FOR THE SOFTWARE OR THE COST OF THIS PRODUCT. SUBJECT TO THE PROVISIONS OF APPLICABLE LAW, IN NO EVENT SHALL THE COMPANY BE LIABLE FOR ANY LOSS OF DATA, LOST OPPORTUNITY OR PROFITS, COST OF COVER OR SPECIAL, INCIDENTAL, CONSEQUENTIAL, OR INDIRECT DAMAGES, EVEN IF YOU ADVISE THE COMPANY OF THE POSSIBILITY OF SUCH DAMAGES. THIS IS A FUNDAMENTAL TERM OF THIS AGREEMENT AND YOU ACKNOWLEDGE THAT THE AMOUNT YOU PAID FOR THE SOFTWARE AND/OR THE PRODUCT REFLECTS THIS ALLOCATION OF RISK. NOTHING IN THIS PARAGRAPH PURPORTS TO EXCLUDE OR LIMIT THE COMPANY'S LIABILITY FOR DEATH OR PERSONAL INJURY CAUSED BY NEGLIGENCE OR ANY OTHER LIABILITY WHICH CANNOT BE EXCLUDED OR LIMITED BY LAW.
5. **Other Third-Party Computer Programs:** As referred to herein, the term "Software" refers only to proprietary Midas™ or Klark Teknik™ software, owned by the Company, that has been provided to you for installation on, or already installed in, a Product. In addition to the Software, you may have also been provided, at no additional charge, with a version of the widely-available GNU Linux Operating System, which is a modular operating system made up of hundreds of individual software components, each of which was written, and the copyright and other rights in which are owned individually, by various parties (collectively, "the GNU Linux Programs"). Each component has its own applicable end user licence agreement, and many of these agreements permit you to copy, modify, and redistribute the applicable software, but you must review the on-line documentation that shares a directory or otherwise accompanies each of the GNU Linux Programs provided to you for the specific terms and conditions. Nothing in this Licence limits your rights under, or grants you rights that supersede, the terms of any other applicable end user licence agreement. If you wish to receive a computer-readable copy of the source code for any of the GNU Linux Programs that have been provided with your Midas™ or Klark Teknik™ Product, send a cheque or money order (no cash accepted), your address and [£10.00] to cover the cost of optical media, postage and handling, to:

MUSIC Group Research UK Limited  
ATTN: Linux Programs CD for Midas™/Klark Teknik™  
Walter Nash Road,  
Kidderminster.  
Worcestershire.  
DY11 7HJ.  
England.

In your request, indicate your Product's name and model number, serial number and version/release information. In your request, also indicate the relevant Software version/release information. This offer, made pursuant to the GNU Linux Programs' end user licence agreements, may expire according to the terms of those agreements, in which case your cheque will be returned to you or destroyed at our option. *Please note that the GNU Linux Programs that may be available to you under this offer consists of the GNU Linux Operating System components only and none of the proprietary application software developed by Midas or Klark Teknik is included.* Other updated Linux distributions containing application software are widely available from a variety of Internet sources, and are often available at minimal or no cost.

6. **Termination:** This Licence will terminate immediately if you violate any of the Licence terms. Upon termination you must discontinue use of the Software, and either destroy, erase or return to Company all copies of the Software in your possession, custody or control, including those in or on the Product.
7. **General:** This Licence constitutes the entire agreement between you and the Company with respect to this Software and, save in the case of fraud, supersedes any other communication (including advertising). Company reserves all rights not expressly granted to you in this licence. If any provision of this Licence is held unenforceable, that provision shall be enforced to the maximum extent permissible so as to give effect the intent of this Licence, and the remainder of this Licence shall continue in full force and effect. This Licence shall be governed by English law

and the Courts of England and Wales will have exclusive jurisdiction to hear and decide any dispute concerning it or its formation. No breach by you of any provision of this Licence shall be waived or discharged except with the express written consent of the Company and no failure or delay by the Company to exercise any of its rights under this Licence shall operate as a waiver thereof and no single or partial exercise of any such right shall prevent any other or further exercise of that or any other right. You acknowledge that the Company could be irreparably damaged if the terms of this Licence were not specifically enforced, and agree that the Company may seek appropriate equitable remedies with respect to breaches of this Licence, including injunctive relief, in addition to such other remedies as the Company may otherwise have available to it under applicable laws.

## **GNU General Public License (GPL)**

For details of the Third Party Software License Attribution, Copyright and Terms and Conditions and Notices, and the GNU LESSER GENERAL PUBLIC LICENSE, see the Midas Digital Equipment GNU General Public License (GPL) Booklet part number DOC04-GPL issue A.



# Contents

Cover page	.....	<b>i</b>
Licences	.....	<b>v</b>
Contents	.....	<b>ix</b>

## Overview

<b>Chapter 1</b>	<b>Introduction</b> .....	<b>1</b>
	About this manual .....	1
	PRO2 host software version .....	3
	Service and support .....	3
<b>Chapter 2</b>	<b>PRO2 Live Audio System</b> .....	<b>5</b>
	Features .....	5
	Applications .....	6
	System components (standard supply) .....	7
	Offline editor .....	7
	System configurations .....	8
	Signal flow .....	11
	Mix matrix .....	12
	Processing .....	12
	Surround capabilities .....	14
	Network .....	14
	Resilience to failure (redundancy) .....	15
	Latency management .....	15
	Operating system .....	15
	GUI .....	15
	Integration of third party hardware .....	15
<b>Chapter 3</b>	<b>About The PRO2 Control Centre</b> .....	<b>17</b>
	Overview of the PRO2 Control Centre .....	17
	PRO2 control surface .....	18
	Connections .....	20
	Keyboard .....	20
	External interfaces .....	20

## Getting Started

<b>Chapter 4</b>	<b>Setting Up The System</b> .....	<b>25</b>
	Initial set-up procedure .....	25
	Unpacking the equipment .....	25
	Installation .....	25

Making up a rack . . . . .27  
 Connecting up . . . . .28  
 Powering the PRO2 system . . . . .30  
 Switching the PRO2 Control Centre on/off . . . . .31

## Basic Operation Of The PRO2

**Chapter 5 Before You Start . . . . . 35**  
 Principles of operation . . . . .35  
 Hints and tips . . . . .35  
 Saving your work . . . . .35

**Chapter 6 Working With The PRO2 Control Centre . . . . . 37**  
 About the PRO2 controls . . . . .37  
 About GUI operation . . . . .38  
 GUI screen layout . . . . .38  
 Parameter values displayed on touch . . . . .40  
 Operating the GUI screen controls . . . . .40  
 Using the GUI menu . . . . .42  
 Text editing . . . . .42

**Chapter 7 Navigation . . . . . 43**  
 An introduction to PRO2 navigation . . . . .43  
 Channel navigation . . . . .43  
 Advanced channel navigation . . . . .44  
 About GUI navigation . . . . .46

**Chapter 8 Patching . . . . . 47**  
 Introduction . . . . .47  
 Terms used in PRO2 patching . . . . .47  
 About the Patching screen . . . . .47  
 Patching tooltips . . . . .59  
 About the patching procedure . . . . .60  
 Configuring the devices . . . . .60  
 Setting up the I/O rack device(s) . . . . .62  
 How to patch . . . . .64

**Chapter 9 Basic Operation . . . . . 69**  
 Setting a mic amplifier's input gain . . . . .69  
 Setting the high and low pass filters . . . . .70  
 Input equalisation (E zone) . . . . .71  
 Input dynamics processing (D zone) . . . . .72  
 Output processing . . . . .73  
 Using VCA/POPulation groups . . . . .74  
 Setting up a mix . . . . .76  
 Setting up the effects rack . . . . .79  
 Simple routing to master stereo outputs . . . . .81  
 Automation . . . . .82  
 Configuring the inputs and outputs . . . . .86  
 Using copy and paste . . . . .87  
 User library (presets) . . . . .88

Surround panning . . . . .	89
Area B operation . . . . .	90
Saving your show files to a USB memory stick . . . . .	91
External AES50 synchronisation . . . . .	92
Security (locking mode) . . . . .	92

## Advanced Operation And Features

<b>Chapter 10</b>	<b>Stereo Linking . . . . .</b>	<b>95</b>
	Changing the linking options . . . . .	96
<b>Chapter 11</b>	<b>Panning . . . . .</b>	<b>97</b>
	Stereo panning . . . . .	97
	SIS™ (LCR) mode . . . . .	98
	Surround panning . . . . .	100
	Speaker placement . . . . .	101
<b>Chapter 12</b>	<b>Soloing . . . . .</b>	<b>103</b>
	Solo A . . . . .	103
	Solo B . . . . .	104
	Solo hierarchy . . . . .	105
	Solo in place (SIP) . . . . .	105
	Solo modes . . . . .	105
<b>Chapter 13</b>	<b>Muting . . . . .</b>	<b>107</b>
<b>Chapter 14</b>	<b>Monitors And Communications . . . . .</b>	<b>109</b>
	Monitors (A and B) . . . . .	109
	Solo system . . . . .	112
	Signal generator . . . . .	116
	Talk osc/routing . . . . .	117
	Talk mic . . . . .	118
<b>Chapter 15</b>	<b>Graphic Equaliser (GEQ) . . . . .</b>	<b>121</b>
	Overview of the GEQs . . . . .	121
	About the Graphic EQs screen . . . . .	121
	About the GEQ window . . . . .	123
	GEQ front panel features . . . . .	124
	Configuring the number of GEQs (and effects) . . . . .	125
	Copying settings between GEQs . . . . .	126
<b>Chapter 16</b>	<b>Internal Effects . . . . .</b>	<b>127</b>
	Overview of the internal effects . . . . .	127
	About the effect window . . . . .	128
	Working with the effects . . . . .	129
	Effect programs . . . . .	129
	Delay effect . . . . .	130
	Virtual DN780 Reverb effect . . . . .	132
	Flanger effect . . . . .	134
	Phaser effect . . . . .	135
	Pitch Shifter effect . . . . .	137



	SQ1 Dynamics effect . . . . .	138
	3-Band Compressor effect . . . . .	139
	Dynamic EQ . . . . .	140
<b>Chapter 17</b>	<b>Control Groups . . . . .</b>	<b>143</b>
	VCA and POPulation groups . . . . .	143
	MCA groups . . . . .	146
	Auto-mute (mute) groups . . . . .	147
	About the control group screens . . . . .	148
	Configuring the groups . . . . .	150
<b>Chapter 18</b>	<b>Copy And Paste . . . . .</b>	<b>151</b>
	Copying through channels/scenes . . . . .	151
<b>Chapter 19</b>	<b>Assignable Controls. . . . .</b>	<b>153</b>
	Operating the channel fader assignments . . . . .	154
	Controlling a rotary control . . . . .	155
	Controlling an internal effect/GEO . . . . .	157
	Controlling a GEO . . . . .	159
<b>Chapter 20</b>	<b>Scenes And Shows (Automation) . . . . .</b>	<b>161</b>
	About automation . . . . .	161
	Automation controls . . . . .	162
	Automation screen . . . . .	163
	Using the right-click menu . . . . .	163
	Scenes . . . . .	164
	Scene contents . . . . .	165
	Point scenes . . . . .	165
	Numbering and navigation . . . . .	165
	Initial snapshot scene (scene 0) . . . . .	165
	Date and time . . . . .	166
	Scene cue list . . . . .	166
	Editing scene properties . . . . .	168
	Adding a new scene . . . . .	169
	Copying and deleting scenes . . . . .	169
	Changing the order of the scenes . . . . .	170
	Overriding store scope . . . . .	170
	Using patching in automation . . . . .	171
	Using zoom . . . . .	171
	Show files . . . . .	172
	Rehearsals . . . . .	173
	Safes . . . . .	174
<b>Chapter 21</b>	<b>Scope (Automation) . . . . .</b>	<b>177</b>
	About scope . . . . .	177
	About the Recall Scope screen . . . . .	177
	Selecting scope parameter sections . . . . .	179
	Saving scope parameters in a scene . . . . .	183
	Using store scope . . . . .	183

<b>Chapter 22</b>	<b>Events (Automation) . . . . .</b>	<b>185</b>
	About events . . . . .	185
	About the Edit Event window . . . . .	186
	Programming events . . . . .	187
<b>Chapter 23</b>	<b>Crossfades (Automation) . . . . .</b>	<b>191</b>
	About the crossfade Edit Event window . . . . .	191
	How a crossfade operates . . . . .	194
	Crossfade groups . . . . .	195
	Global events . . . . .	197
	Manually controlling a crossfade . . . . .	198
<b>Chapter 24</b>	<b>User Libraries (Presets) . . . . .</b>	<b>199</b>
	About the Preset Manager screen . . . . .	199
	Managing user libraries . . . . .	201
	Deleting presets from a user library . . . . .	202
<b>Chapter 25</b>	<b>File Management . . . . .</b>	<b>203</b>
	About the Files screen . . . . .	203
<b>Chapter 26</b>	<b>Using Other Devices With The PRO2 . . . . .</b>	<b>205</b>
	Using multiple digital consoles . . . . .	205
	Using an external USB mouse . . . . .	206
	Using a USB keyboard . . . . .	206
	Using an external monitor . . . . .	206
<b>Chapter 27</b>	<b>Changing The Preferences . . . . .</b>	<b>207</b>
	Setting the meter preferences . . . . .	207
	Configuring a virtual soundcheck . . . . .	207
	Configuring playback . . . . .	208
	Restoring the PRO2 defaults . . . . .	208
	Checking the build information . . . . .	208
	Using patching in automation . . . . .	208
	Selecting the surround mode . . . . .	209
	Setting the time and date . . . . .	209
	Setting the user interface preferences . . . . .	209
	Setting the navigation mode . . . . .	210
	VCA unfolding . . . . .	211
	Changing the default input/output names . . . . .	211
	On-scene store . . . . .	212
	Changing the signal processing preferences . . . . .	212
	Adjusting PRO2 illumination . . . . .	212
	Selecting the function of the foot switch(es) . . . . .	212
	Selecting the fan speed . . . . .	213
	Remote control server . . . . .	213
	Configuring the channels, groups and internal units . . . . .	213
<b>Chapter 28</b>	<b>Delay Compensation (Latency) . . . . .</b>	<b>215</b>
	Insert compensation . . . . .	215
	GEQ compensation . . . . .	216
	GUI Delay Compensation options . . . . .	216
	Monitor Mode (Align with Masters) . . . . .	218

Zones .....219  
 Masters to matrix tap-off-point .....220  
 Typical configurations .....221

## Description

**Chapter 29 Panel Connections ..... 227**  
 Rear panel connections .....227  
 Control surface .....235

**Chapter 30 Input Channels ..... 237**  
 Input channel routing .....237  
 Input channel areas .....238  
 Inputs on the GUI .....239  
 Input metering .....241  
 Channel configuration controls .....242  
 Mic amp input gain (preliminary input processing) .....244  
 Dynamics (D zone) .....249  
 Insert .....256  
 EQ (E zone) .....257  
 Mixes .....259  
 Master controls .....261  
 Solo, mute and fader .....263  
 Aux returns .....264

**Chapter 31 Output Channels ..... 265**  
 Output channel routing .....265  
 Output channel areas on the control surface .....266  
 Outputs on the GUI .....267  
 Output metering .....271  
 Talk .....272  
 Dynamics and EQ .....272  
 Mute, safes, level and solo .....278  
 Output channel configuration controls .....279  
 Mixes .....282  
 Masters .....282

**Chapter 32 GUI Menu. .... 283**  
 GUI menu flowchart .....284  
 GUI menu options .....285

## Appendices

**Appendix A Application Notes ..... 289**  
 Spatial imaging system (SIS™) .....289  
 PRO2 compressor modes (dynamic) .....289  
 PRO2 input channel EQ modes .....292  
 PRO2 output channel EQ modes .....293

<b>Appendix B</b>	<b>Functional Block Diagrams. . . . .</b>	<b>295</b>
	Mono input channel signal flow . . . . .	296
	Returns signal flow . . . . .	297
	Aux/group signal flow . . . . .	298
	Master signal flow . . . . .	299
	Mono mix signal . . . . .	300
	Monitor signal flow . . . . .	301
	Comms signal flow . . . . .	302
	Dynamics signal flow . . . . .	303
<b>Appendix C</b>	<b>Technical Specification. . . . .</b>	<b>305</b>
	PRO2 general statistics . . . . .	305
	PRO2 general specifications . . . . .	306
	PRO2 audio performance specifications . . . . .	307
	PRO2 system inputs and outputs . . . . .	311
	Inputs and output characteristics . . . . .	313
	Main processing functions . . . . .	314
	Status functions . . . . .	317
<b>Appendix D</b>	<b>Troubleshooting . . . . .</b>	<b>319</b>
	No audio . . . . .	319
	Troubleshooting automation . . . . .	319
<b>Appendix E</b>	<b>Updating The PRO2 Host Software . . . . .</b>	<b>329</b>
	About the PRO2 updater . . . . .	329
	About the updater screen . . . . .	330
	Using the PRO2 updater . . . . .	332
<b>Appendix F</b>	<b>Parameters Affected By Scope. . . . .</b>	<b>337</b>
	Introduction . . . . .	337
	Overview . . . . .	338
	Inputs . . . . .	339
	Returns (Aux Returns) . . . . .	350
	Auxes (Aux Sends) . . . . .	356
	Matrices . . . . .	363
	Masters . . . . .	369
	GEQ rack . . . . .	376
	Effects rack . . . . .	378
	Groups . . . . .	380
<b>Appendix G</b>	<b>Parameters Affected By Automate Patching . . . . .</b>	<b>381</b>
	Inputs . . . . .	381
	Auxes . . . . .	382
	Matrices . . . . .	382
	Masters . . . . .	383
	Effects . . . . .	383
	System devices . . . . .	384
	Monitors . . . . .	384
<b>Appendix H</b>	<b>Parameters Protected By Safes . . . . .</b>	<b>385</b>
	Overview . . . . .	385
	Inputs . . . . .	386

	Auxes (Aux Sends) . . . . .	396
	Returns (Aux Returns) . . . . .	405
	Matrices . . . . .	410
	Masters . . . . .	419
	Groups . . . . .	428
<b>Appendix I</b>	<b>Parameters Affected By Copy And Paste. . . . .</b>	<b>431</b>
	Overview . . . . .	431
	Inputs . . . . .	432
	Aux . . . . .	440
	Return . . . . .	446
	Matrix . . . . .	449
	Master . . . . .	455
<b>Appendix J</b>	<b>Parameters Affected By Stereo Linking. . . . .</b>	<b>461</b>
	Overview . . . . .	461
	Input Channels . . . . .	462
	Aux Returns . . . . .	474
	Aux Sends . . . . .	482
	Matrix . . . . .	492
	Masters . . . . .	500
<b>Appendix K</b>	<b>Parameters Copied Through Scenes . . . . .</b>	<b>511</b>
	Inputs (input channels) . . . . .	512
	Aux Returns (return channels) . . . . .	522
	Aux Sends (aux channels) . . . . .	528
	Matrix (matrix channels) . . . . .	535
	GEQs . . . . .	541
	Effects . . . . .	541
	VCA/POPulation (groups) . . . . .	542
	Masters (master channels) . . . . .	542
	Misc (miscellaneous) . . . . .	549
<b>Appendix L</b>	<b>Service Information . . . . .</b>	<b>551</b>
	Electrostatic discharge (ESD) precautions . . . . .	551
	Routine maintenance . . . . .	551
	Cleaning the control centre . . . . .	551
	Cleaning the GUI screen . . . . .	552
	Equipment disposal . . . . .	552
<b>Glossary</b>	. . . . .	<b>553</b>

# *Overview*





# Chapter 1: Introduction

Welcome to the PRO2 Live Audio System. The PRO2 Live Audio System is a very powerful and flexible audio processing system that provides a complete solution for any audio mixing and signal distribution application in a live sound environment.

The PRO2 Control Centre, which forms an integral part of the PRO2 Live Audio System, was conceived by Midas to offer audio professionals high-performance audio equipment, designed to provide no-compromise sonic quality with a feature set that offers all essential facilities and functions. It represents the very best of British design and engineering combined with contemporary, efficient manufacturing methods, and will give you many years of reliable service.

So, to obtain the best results with a minimum of effort, please read this Operator Manual and, finally, enjoy your Midas PRO2 Live Audio System!

## About this manual

This is the Owner's Manual for the PRO2 Live Audio System. Its purpose is to familiarise the user with the PRO2 Live Audio System and show how to install, configure and operate the PRO2 Control Centre.

**Note:** *The content of this Operator Manual does not supersede any information supplied with any other item of the PRO2 Live Audio System.*







## Structure

To help you find your way around the manual, it has been divided into the following main areas (volumes):

- **Overview:** This gives an overview of the PRO2 Live Audio System and PRO2 Control Centre and contains information about this manual.
- **Getting Started:** This shows you how to set up and power up a PRO2 Live Audio System.
- **Basic Operation Of The PRO2 Control Centre:** This shows you how to use the controls of the PRO2 Control Centre, how to navigate the control surface and GUI, how to route (patch) the channels and buses, and how to carry out basic operations in order to get some audio out of it.
- **Advanced Operations And Features:** This describes the advanced features of the PRO2 and gives detailed operating instructions.
- **Description:** This gives a detailed description of the PRO2 Control Centre hardware, and the controls and their functions on both the control surface and GUI. It provides useful reference material.
- **Appendices:** This provides additional reference material and technical information on the PRO2, such as application notes, signal path diagrams, technical specifications, service information etc.

## Conventions

The following lists the conventions used in this manual.

- Hand symbols, such as,  (for pushbutton, trackball, glide pad etc.) and  (for control knob), are used to show the operation of the physical controls on the control surface. GUI operation is indicated by a pointer, which represents a 'click'  or 'drag'  operation.
- The graphics shown right are used to differentiate between diagrams of the control surface (immediate right) and GUI (far right). 
- Unless otherwise stated, illumination of a control (pushbutton, switch, control knob etc.) on the control surface/GUI of the PRO2 Live Audio System indicates an "on", "active" or "enabled" state. Conversely, an extinguished condition indicates the control is "off", "inactive" or "disabled".
- 'Selecting' an option on the GUI enables that option, as indicated by a symbol, such as a tick ✓ or cross X. An empty option is unselected (disabled).
- The following types of pushbutton are used on the control surface:
  - "switch" - a latching pushbutton, that is, one that changes its on/off status.
  - "button" - a non-latching pushbutton.
- Generally, control names are the same whether they are on the control surface or the GUI. However, in cases where they differ, both names will be given, separated by a forward slash "/". The control name shown on the GUI will always be last and enclosed in square brackets "[]".
- Hints and tips, which convey useful information to the user, appear where you see the drawing pin graphic (shown right). 

## Terminology

To clarify the understanding and use of the digital console and to discriminate between its analogue equivalent, the terminology has been chosen very carefully (see "Glossary" on page 553). For a definition of the PRO2's primary buses, see "Definition of the primary buses" on page 15.

## GUI diagrams

This manual contains numerous diagrams that represent the GUI screen displays. Due to the many permutations of control settings, operating status, channel configurations etc., it is inevitable that these diagrams will look slightly different to those on your control centre.

### **Anti-aliasing**

To make GUI of the PRO2 as crisp, eye-catching and intelligible as possible it incorporates an anti-aliasing algorithm to ensure the utmost smoothness of straight lines and curves. Unfortunately, the process of reproducing GUI displays for this manual has resulted in an inevitable loss of quality, which in some cases has led to a certain amount of pixelation. Therefore the quality of the actual GUI display on the PRO2 is not truly reflected here.

## PRO2 host software version

This manual is for an PRO2 Control Centre running host software version 1.15 and later.

## Service and support

The PRO2 is a very hi-tech piece of equipment. We provide superb levels of support and service to give users confidence in Midas digital products.



## Chapter 2: PRO2 Live Audio System

The PRO2 is a mid-size mixing console and comes complete with a stage IO box and flight case. The console is designed to work for long periods, not just indoors but under harsh sunlight or near freezing conditions.

The console forms the core of the PRO2 Live Audio System, whose network carries both proprietary control data and open architecture AES50 digital audio, and uses readily available standard cabling and connectors. The PRO2 uses the reliable Linux operating system.

The PRO2 Live Audio System incorporates dual redundancy on mains power, facilitated by two mains inlets.

Additional AES50-compatible sound processing products can be connected to the PRO2 to form extended distribution and mixing console "system".

### Features

Please remember, the PRO2 is not just a console, it's a LIVE PERFORMANCE SYSTEM!

- Available in 8-channel (PRO2C) and 16-channel (PRO2) versions
- XL8-Style "Fast Zones"
- Midas preamps, which accommodate easy passive splitting (optional DL431 mic pres give integral splits for connecting to analogue/digital consoles)
- Offline editor
- 156 inputs x 166 outputs (maximum capacity) point-to-point routing anywhere within the network
- 56 mic/line inputs with Midas mic preamps
- 64 simultaneous input processing channels
- 32 analogue outputs (including 2 stereo local monitor outputs)
- Monitor mixing is simple — master, matrix and aux buses can be routed directly from input channels with independent level control, giving 24 monitor mix buses
- Traditional FOH subgroup mixing is simple — any/all aux buses can operate as post-channel fader and pan (aux gain fixed at unity)
- Aux inputs have two modes of operation: effects return and input channel
- Three AES3 outputs
- Two AES3 inputs
- Six AES50 on the Control Centre for I/O expansion and XL8 connectivity
- 27 sample-synchronous, phase-coherent mix buses
- Six multi-channel FX engines
- Up to 28 Klark Teknik DN370 31-band Graphic EQs
- Configurable "Area B"
- Surround panning including 5.1, Quad and LCRS
- Full-colour 15" daylight-viewable display screen with DVI out

- Eight VCA (Variable Control Association) groups
- Six POPulation groups
- 192 MCA (Mix Control Association) groups
- Automation providing up to 1,000 scenes with snapshot save/recall capability and global edit, presets and show file archiving
- Comprehensive, easy-to-use routing via a GUI Patching screen
- 96kHz 40-bit floating-point processing throughout
- 100m bi-directional Cat-5e AES50 digital snake included (48 in x 16 out)
- Stage I/O: DL251 48 in/16 out fixed configuration
- Dual redundant hot swappable power supplies
- Three year factory warranty

### **Additional I/O Box Options**

- DL431: 24 inputs in a five way split in a fixed configuration I/O
- DL252: 16 inputs/48 outputs in a fixed configuration I/O
- DL351: up to 64 inputs/64 outputs in a configurable I/O
- DL451: up to 24 inputs/24 outputs in a configurable I/O

### **Accessories**

- Klark Teknik DN9331 Rapide Graphic Controller
- Klark Teknik DN9696 96-track High Resolution Audio Recorder
- Klark Teknik DN9650 Network Bridge (MADI, Dante, Aviom, Ethersound, CobraNet)

## **Applications**

Although the PRO2 is designed for the traditional touring live sound environment, it is also ideal for medium-sized theatre, small house of worship installations and broadcast. So, being a truly multi-function console in the Midas tradition, the PRO2 is suitable for many applications, such as:

- Live concert sound touring (medium and small scale productions).
- Live concert sound fixed install (medium and small).
- Live sound small theatre MON or FOH duties.
- Live sound house of worship MON or FOH duties.
- Corporate work.
- TV broadcast small outside broadcast (OB) truck.

## System components (standard supply)

The PRO2 Live Audio System can be supplied in either a touring package or install package. In both packages the following is supplied as standard.

- **PRO2 Control Centre:** PRO2 (16-channel) or PRO2C (8-channel).



- **DL251 Audio System I/O (1-off):** 6U 19" rack unit that provides 48 mic/line inputs and 16 outputs.



- **Snakes and main cables etc.**

To provide a complete audio system, the only other equipment required are mics, amplifiers and loudspeakers.

### Touring package

In the touring package, the PRO2 is flight-cased. Also included are three 10 m cables bundled together and supplied on a reel as a 'snake' (single copper).

### Install package

The install package includes short cables, and all the equipment is supplied in cardboard boxes.

### Offline editor

The offline editor is an application that runs on a Mac and can create and edit shows compatible with any midas digital console.



## System configurations

This section shows the basic interconnectivity of a PRO2 Live Audio System and the possible system configurations.

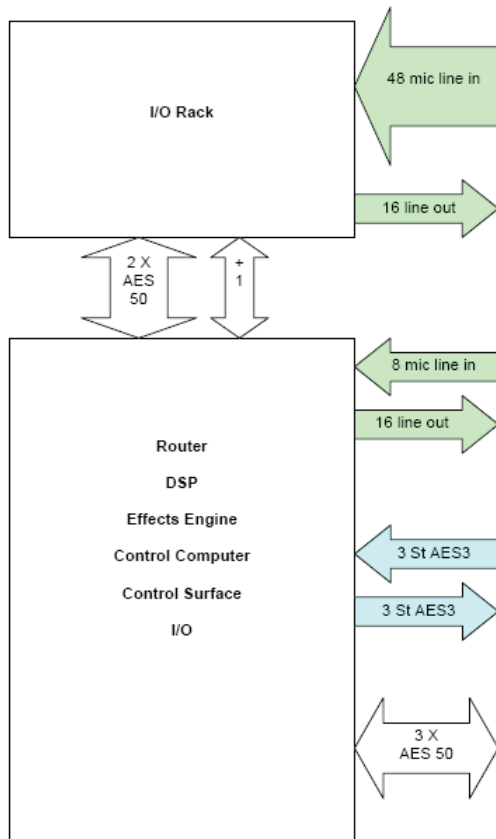

*Basic interconnectivity of a standard PRO2 Live Audio System*



*PRO2C standard system (compact)*



*PRO2 system expanded by adding DL431 input splitters and DL451 modular I/O boxes*

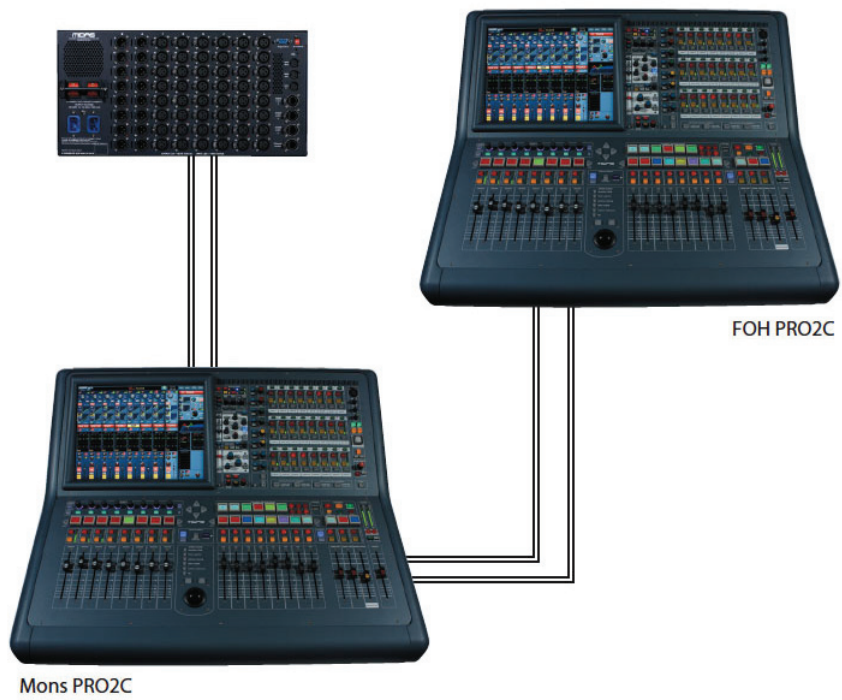

*Dual PRO2C FOH and MON system using a DL251 split network*

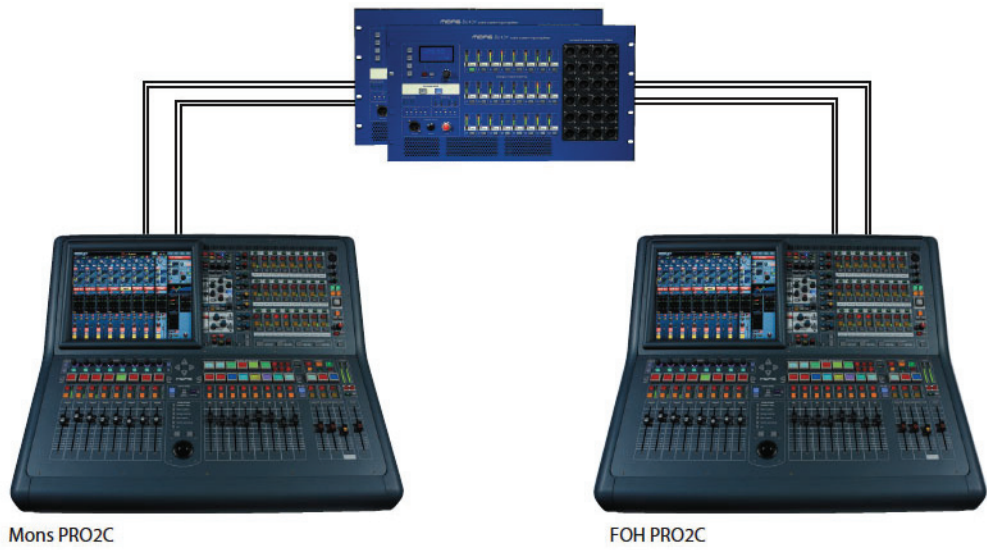

Dual PRO2C FOH and MON system using XL8 DL431 input splitters

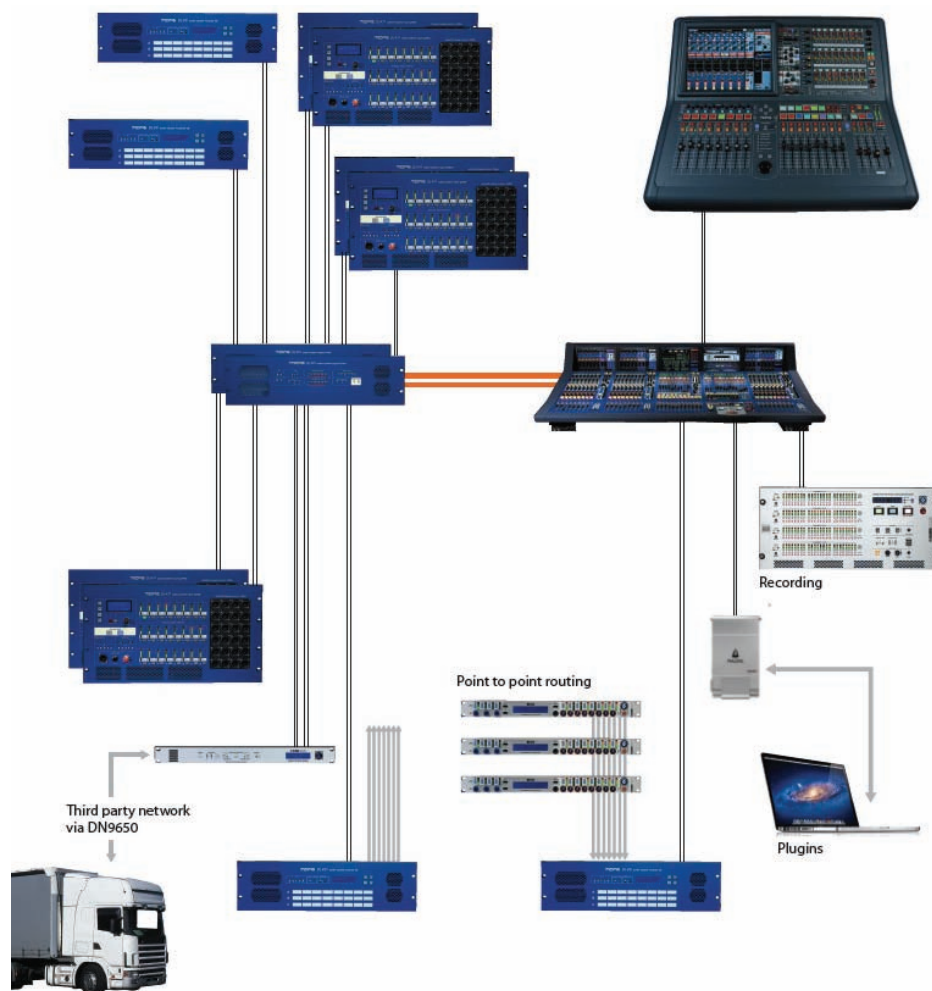

PRO2C and XL8 sidecar network with up to 576 inputs and up to 224 simultaneous channels. The PRO2C control centre and engine are connected to the XL8 network as an extender. The channel count depends upon the number of I/Os and their configuration.

## Signal flow

The control surface contains the DSP engine, which provides the following time-aligned channels and buses:

- 56 input channels
- 8 aux input channels optionally time-aligned as effects returns or additional input channels
- 16 aux output channels
- 3 master channels
- 8 matrix channels
- 2 solo buses, routable from all locations providing dual monitor formats (in ear/wedge)
- 2 master buses, routable from the 56 inputs and 8 aux inputs, and 16 aux buses
- 8 matrix buses, routable from the 56 inputs and 8 aux inputs, 16 aux buses and 3 masters
- 16 aux buses, routable from the 56 inputs and 8 aux inputs

Monitor mixing is easily catered for because the master, matrix and aux buses can all be routed directly from the input channels with independent level controls providing up to 24 monitor mix buses.

Traditional FOH sub group mixing is easily catered for as the aux buses can be individually configured to operate post-channel fader and pan (that is, aux gain fixed at unity).

Auxiliary inputs have two modes, effect return and input channel (default). In input channel mode they are time aligned to the stage and operate as the input channels except for they have no dynamics. In effects return mode they are time aligned to the effects engine and can only route to the matrix and master channels.

## Mix matrix

Ultimately, the mix matrix defines the PRO2 Live Audio System's capability. Probably the best way to imagine the mix matrix is to think of an analogue console layout, where inputs run vertically and buses run horizontally. A mix matrix is usually defined as the number of buses and the quantity of simultaneously-mixable inputs there are per bus. The following diagram illustrates the capability within the control centre.

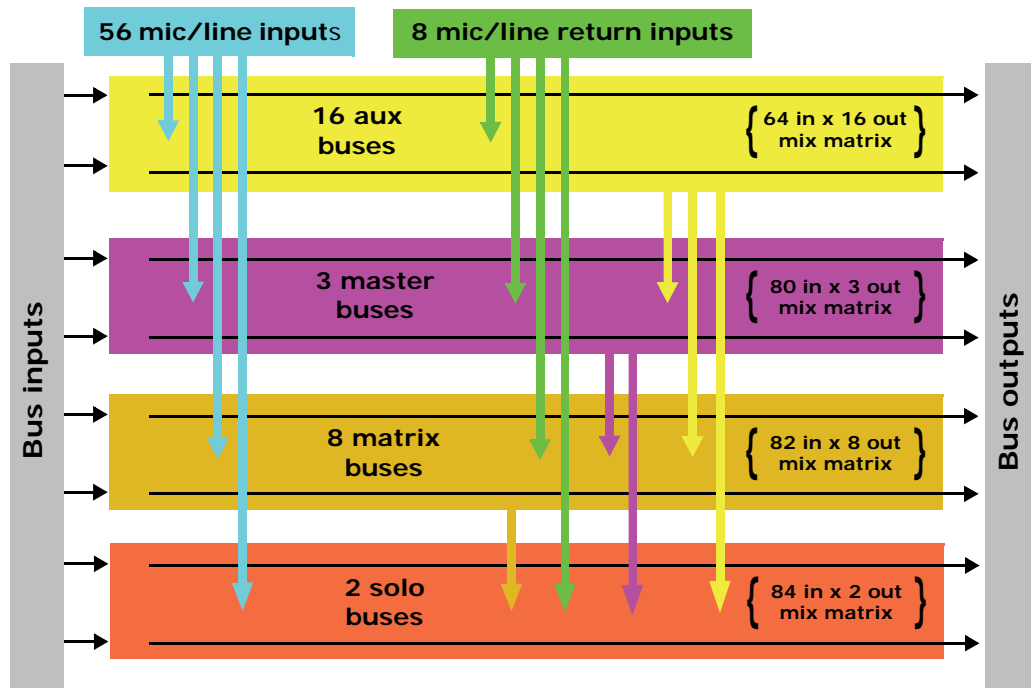

## Processing

Although the control centre system allows for considerable insertion of external processing, it also embodies more than enough internal high quality processing to eliminate the need for this.

### Input channel processing

Each of the 56 full-function input channels has:

- Analogue and digital gain.
- Phase reverse switch.
- Input delay.
- Swept high pass filter with choice of two filter slopes.
- Swept low pass filter with choice of two filter slopes.
- Frequency-conscious compressor with choice of four compression styles.
- Frequency-conscious noise gate with external side chain.
- Insert point.
- Treble EQ filter with choice of four filter types.
- Parametric hi-mid EQ filter.
- Parametric lo-mid EQ filter.
- Bass EQ filter with choice of four filter types.
- Routing via level controls to 24 mix buses.
- Routing via pan control to left and right master buses.

- Routing to mono master bus.
- Panpot (SIS™).
- Direct output.

Each of the 16 auxiliary inputs has:

- Input gain.
- Source from internal FX or external pool input.
- Fader.
- Panpot (SIS™).
- Routing via level controls to the eight matrix buses.
- Routing via pan control to the left, right and mono master buses.

### Mix channel processing

Each of the 16 auxiliary mix buses has:

- Subgroup, auxiliary or mix minus modes.
- Dual mono or stereo pair modes.
- Six-band PEQ.
- Optional 31-band GEQ (replaces PEQ).
- Frequency-conscious compressor with soft clip limiter and choice of five compression styles.
- Insert point.
- Routing via level controls to the 6 matrix buses.
- Routing via pan control to the left, right and mono master buses.
- Direct input.

Each of the eight matrix buses has:

- Six-band PEQ.
- Optional 31-band GEQ (replaces PEQ).
- Five-mode frequency-conscious compressor with soft clip limiter and external side chain.
- Insert point.
- Direct input.

### Output channel processing

Each of the eight matrix buses has:

- Six-band PEQ.
- Optional 31-band GEQ (replaces PEQ).
- Five-mode frequency-conscious compressor with soft clip limiter and external side chain.
- Insert point.
- Direct input.

The two master output buses each has:

- Six-band PEQ.
- Optional 31-band GEQ (replaces PEQ).
- Five-mode frequency-conscious compressor with soft clip limiter and external side chain.
- Insert point.
- Direct input.

## Effects processing and GEOs

The PRO2 contains eight mono Klark Teknik (KT) GEOs and eight effects processors as standard.

The effects processors (six maximum) can be freely chosen from the following:

- Stereo delay.
- Stereo flanger.
- Stereo phaser.
- Stereo harmoniser.
- Stereo reverb (KT DN780).
- Stereo Dynamic EQ.
- GEO (each effect slot can be sacrificed to gain an additional four GEO effects).
- Eight channels of SQ1 Dynamics.

Up to 28 mono KT GEOs can be patched into any output. There are many patching options for the effects processors. They can be patched to any source or destination within the system and you can even patch directly to and from an effect externally.

## Surround capabilities

Theatres and broadcast have differing requirements for surround, and both are catered for in the PRO2.

Conventional stereo and SIS™ panning is assignable on a channel by channel basis (channel one can be in stereo while channel two can be in SIS™), as follows:

- Stereo left–right routing to master buses.
- SIS™ left–right–centre routing to master buses.

Three additional surround modes operate as follows:

- Quad (left, right, LS and RS).
- Surround (left, centre, right surround).
- 5.1 surround (left, centre, right, subwoofer (LCRS), LS and RS).

## Network

The PRO2's digital audio network utilises the physical connectivity of Ethernet (EtherCon® connectors and Cat 5e/Cat6 cable), but replaces its data protocol with AES50 protocol (implemented as SuperMAC) and the HyperMAC high capacity system, which are more suited to high quality, low latency audio distribution. The use of the AES standard allows straightforward interfacing with any third party hardware that also utilises this connection.

AES50 and HyperMAC connections carry digital audio, control data and standard Ethernet traffic bi-directionally down a single cable. Cat 5e cable is used for the 'local' (24-channel) connections and the single digital 'snake'<sup>1</sup> — between control centre and router — is either Cat 5e/Cat6 or fibre optic. The combination of audio, control, clock and third party Ethernet data in a single network means that the hardware interfaces on a single RJ45 connection.

All system connections are duplicated for full dual redundancy.

---

1. The digital snake is equivalent to a 384-channel analogue multi-core cable (192 channels in each direction).



## Resilience to failure (redundancy)

The PRO2 Control Centre has dual redundant power supplies, so if one fails the other can carry on working. The N+1 principle is used for the audio, where the AES50 cables include a redundant spare.

The GUI screen can be used to operate the control centre, *even if no control surface hardware is working.*

## Latency management

In the interests of reduced latency the primary channel types are restricted to three time zones and the interconnecting buses are restricted to the time in between.

- **First time zone:** Input channels, including aux inputs that are set to input channel mode. (Aux bus time is here.)
- **Second time zone:** Aux channels, including aux inputs that are set to effects return mode. (Master and matrix bus time is here.)
- **Third time zone:** Master and matrix outputs.

## Operating system

The PRO2's operating system is Linux, which is an open-source, stable, proven operating system (OS). Linux is used in many mission-critical applications worldwide and has allowed Midas' software engineers to write a ground-up system that contains no 'hidden' or unused code. This has resulted in an efficient, compact application, which is quick in operation, quick booting and comparatively easy to debug.

## GUI

The PRO2 has a, daylight-viewable, TFT screen that provides overview and detail status indication. The screen operated using a trackball and two buttons that, between them, provide the same control as provided by a computer's mouse.

The supplied USB keyboard lets you insert text into fields on the GUI screen.

## Integration of third party hardware

The PRO2 network includes the capability to interface any third party hardware that uses AES/EBU or AES50 digital audio, or a standard analogue audio interface.

Each PRO2 AES/EBU input and output has a sample rate converter. Synchronisation to external AES3 interfaces can be:

- Global - via inputs on the routers.
- Local to each input.
- Local to each output (synchronisation to adjacent local output).

Multiple local connections can be at different sample rates.

The use of the AES50 protocol for the transmission of digital audio means that any third party digital audio hardware that features this connection can be connected to the Midas network, and will transfer audio to and from the Midas hardware without any additional interfaces or converters (provided it runs in TDM 96kHz mode). This will be particularly useful as the protocol gains acceptance with recording and playback devices, loudspeaker controllers, audio networking systems, digital amplifiers etc.

The PRO2 Control Centre has a DVI connector on the rear panel, so that the control centre view can be routed to an external monitor.



## Chapter 3: About The PRO2 Control Centre

This chapter introduces you to the PRO2 Control Centre and provides a brief hardware description.

### Overview of the PRO2 Control Centre

The PRO2 Control Centre comprises a combined control surface and graphical user interface (GUI) that provides an array of easy-to-use controls for the precise manipulation of audio.

The control surface has been designed to emulate the fast access of an analogue control surface by presenting things in a familiar, consistent and logical way. This is enhanced by visual representations on the GUI screen at the top, which also provides extra functionality.



*PRO2 (left) and PRO2C control centres*

The PRO2 Control Centre is built on a robust Midas steel frame chassis similar to those used for established Midas analogue products. The frame houses two main bays (three on the PRO2) that, collectively, provide the primary mixing needs of the engineer.

## PRO2 control surface

During show time the functions that require fast access are controlled by control knobs (rotary encoders), pushbutton switches, faders etc. More complex functions that do not require this fast access are controlled via the GUI screen using the trackball and left and right navigational keys.

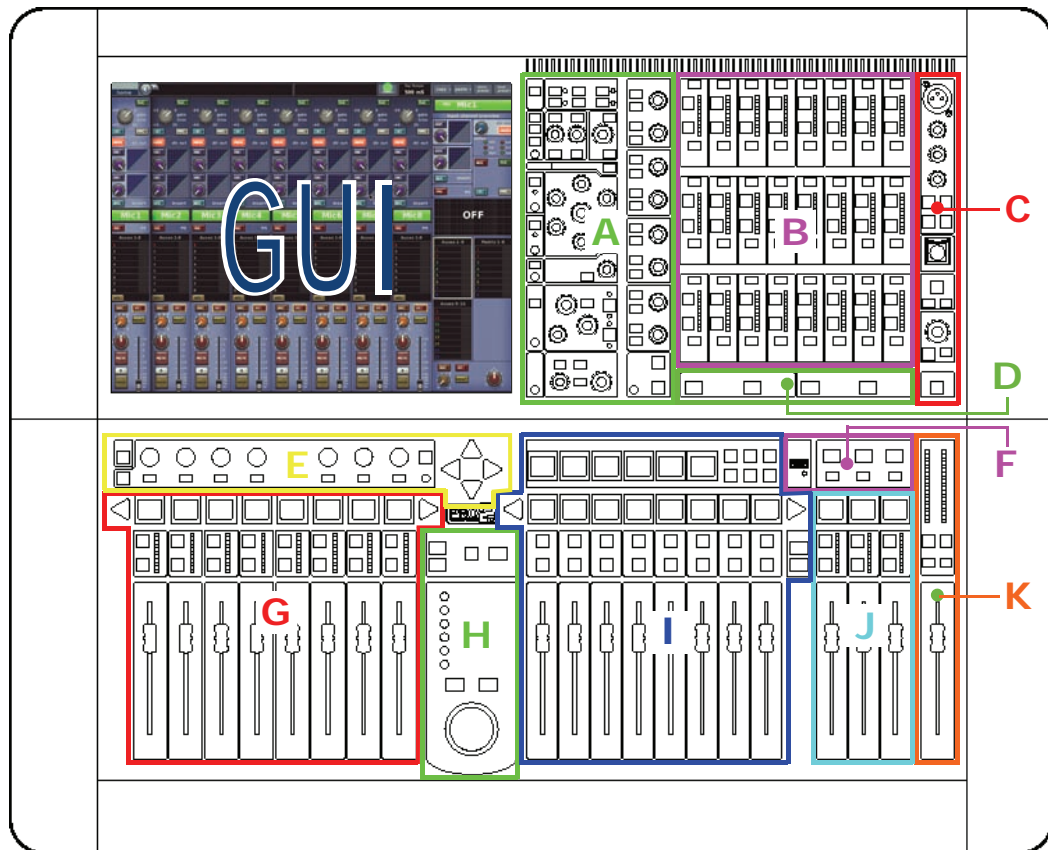

Main areas of control surface

Item	Description
A	<b>Channel detail areas</b> Contains detail areas, such as the D-zone (dynamic), E-zone (EQ) and mix buses, that provide a more comprehensive control of a channel or mix bus by allowing detailed audio parameter adjustment. Includes mix bus navigation controls.
B	<b>Outputs</b> The output controls are limited to basic switch functions, such as, mute, solo, talk and select, along with signal metering, so that all 24 outputs can be shown at the same time. Outputs can be assigned to channel or mix bay faders. The selected output will be assigned to the "selected mix" fader on the master bay. The output area does not require any direct support from the GUI.
C	<b>Comms</b> Talk, solo, headphones, etc.
D	<b>Advanced navigation controls</b> For activating advanced navigational functions, such as flip, MCAs and GEO.
E	<b>I zone</b> Operator-assignable device controls.
F	<b>Automation and USB</b> Scene store/recall and USB connection.

<i>Item</i>	<i>Description</i>
<b>G</b>	<p><b>Input fast zone</b> Contains the operator's 'must have now' controls in eight input fast strips. Provides faders, meters, mutes, solos and navigation (LCD) switches for detailed and complex manipulation of multiple channels within the console. Typically, this would be input channels but aux returns and output can also be accessed. This is achieved by scrolling to the right (the order is inputs/returns/aux send/matrix/masters) or by using the <b>INPUT</b> and <b>OUTPUT</b> buttons.</p> <p>Eight channel faders and eight horizontal assignable controls operate in conjunction with a vertical channel detail controller and the GUI screen. The usable channel fader control can be increased to 16 by activating the <b>EXTEND</b> button which allows the channel fader to extend over the usual mix faders (temporarily overriding them).</p> <p>The additional input bay of the PRO2 (16-channel version) operates in an identical manner to this area.</p>
<b>H</b>	<p><b>Navigation zone</b> For GUI screen navigation via a trackball. Includes a <b>screen access</b> panel for direct GUI screen access.</p>
<b>I</b>	<p><b>Mix fast zone</b> Eight mix faders (with LCD switches) give the operator primary mix control. To select an output mix, press the <b>OUTPUT</b> button and scroll left and right. To assign the VCAs to the mix bay faders, press the <b>VCA</b> button.</p> <p>Additional input channel faders can be provided by using <b>EXTEND</b>, which override the mix faders. They attach themselves numerically to right of the channels assigned to the channel faders. Pressing <b>OUTPUT</b> or a VCA LCD select button returns them to their previous state (showing either VCAs or outputs as appropriate).</p> <p>The POPulation groups provide instant navigation to a user-defined set of channels. When a POPulation group is selected, they are mapped to the input bay faders and, when in <b>EXTEND</b> mode, the mix bay faders.</p>
<b>J</b>	<p><b>Masters and area B</b> This section, which does not require any direct support from the GUI, has three faders (each with LCD switch, meters solo and mute). By default, these control the left, right and mono master outputs. However, they can also be overridden for use as an "Area B", where VCA and POPulation groups can be unfolded to. They are always independent of the channel and mix faders, that is, they cannot be set to area A to become channels 9 and 10.</p> <p>The third fader is the mono channel. This fader is distinct from the other two, as it can be overridden by the output select buttons. (When unfolding a VCA or POPulation group to Area B only the first three channels are accessible.)</p>
<b>K</b>	<p><b>monitors</b> Monitor left and right.</p>

## Connections

The PRO2 has a rear connector panel that caters for the connection of mains power leads, AES50 I/O unit(s), USB devices, keyboards, headphones, talk mics, communications, external monitor, AES3 synchronisation, diagnostics (for service personnel only), lamp and word clocks (75R).

The control surface houses a USB connector for uploading/downloading show files and updating the system software, and a connector for a talk mic.



*Rear panel connectors (top) and storage USB connector on the control surface*

For more information, see Chapter 29 "Panel Connections" on page 227.

## Keyboard

A QWERTY keyboard is supplied that is used mainly for inputting text, such as when configuring a channel or using automation.

## External interfaces

Various devices can be used with the PRO2, such as:

- **External USB mouse:** Instead of using the navigation zone to operate the GUI screen, you can use an external USB mouse. This can be plugged into one of the USB connectors on the rear panel of the PRO2. The USB mouse behaves in the same way as any PC mouse.
- **External USB keyboard:** You can plug a USB keyboard into one of the USB connectors on the rear panel of the PRO2.
- **MIDI:** Standard 5-pin connectors are housed in the rear panel of the PRO2 for use as MIDI in, out and through ports.

- **USB:** Two USB ports are provided on the rear panel of the PRO2. In addition, there is a USB port on the control surface (**storage** section) for removable storage via a USB memory stick.
- **DVI ports for external monitor:** The control centre has a **screen output** DVI connector on the rear panel of the PRO2 for connecting an external monitor. This lets you view remotely what is shown on a GUI screen.





# *Getting Started*



## Chapter 4: Setting Up The System

- !** Before installing, setting up or operating this equipment, make sure that you have read and fully understand all of this section and the “IMPORTANT SAFETY INSTRUCTIONS” at the front of this manual.

This chapter shows you how to set up an PRO2 Live Audio System to its default configuration.

*Note: If you want to set up the PRO2 Live Audio System using a configuration other than the default, please contact Midas Technical Support for details.*

### Initial set-up procedure

Initial system set-up basically comprises:

- **Unpacking and checking the equipment** — see “Unpacking the equipment” below.
- **Making up the rack** — see “Making up a rack” below.
- **Installation** — see “Installation” below.
- **Connecting up the equipment** — see “Connecting up” on page 28.
- **Powering the equipment** — see “Powering the PRO2 system” on page 30.
- **Setting up the I/O rack device (initial patching)** — see “Configuring the devices” on page 60.
- **Configuring the DL251 Audio System I/O unit** — see the DL251/DL252 Audio System I/O Operator Manual.

### Unpacking the equipment

After carefully unpacking the equipment, check it against the packing list shown in “System components (standard supply)” on page 7.

Save all packing materials, as they will prove useful if you need to transport the equipment later.

Inspect the equipment carefully for any sign of damage incurred during transportation. It has undergone stringent quality control inspection and tests prior to packing and was in perfect condition when it left the factory. However, if the equipment shows any signs of damage, notify the transportation company without delay. Only you, the consignee, may institute a claim against the carrier for damage during transportation.

### Installation

Before installing the equipment:

- Make sure the equipment is correctly connected to the protective earth conductor of the mains voltage supply of the system installation through the mains leads.
- Power to the equipment must be via a fused spur(s).
- Power plugs must be inserted in socket outlets provided with protective earth contacts. The electrical supply at the socket outlets must provide appropriate over-current protection.

- Both the mains supply and the quality of earthing must be adequate for the equipment.
- Before connecting up the equipment, check that the mains power supply voltage rating corresponds with the local mains power supply. The rating of the mains power supply voltage is printed on the equipment.

### Handling the equipment

Completely isolate the equipment electrically and disconnect all cables from the equipment before moving it.

When lifting or moving the equipment, always take its size and weight into consideration. Use suitable lifting equipment or transporting gear, or sufficient additional personnel.

Do not insert your fingers or hand in any gaps or openings on the equipment, for example, vents.

Avoid inserting or dropping foreign objects, such as paper, plastic, metal etc., into any gaps or openings on the equipment, for example, vents. If this happens, immediately disconnect the equipment from the AC mains. Then have the equipment inspected by the manufacturer's qualified service personnel.

Do not press or rub on the sensitive surface of the GUI screens.

If the glass of the GUI screen is broken, liquid crystals shouldn't leak through the break due to the surface tension of the thin layer and the type of construction of the LCD panel. However, in the unlikely event that you do make contact with this substance, please wash it out with soap.

### Location

Ideally a cool area is preferred, away from power distribution equipment or other potential sources of interference.

Do not install the equipment in places of poor ventilation.

Do not install this equipment in a location subjected to excessive heat, dust or mechanical vibration. Allow for adequate ventilation around the equipment, making sure that its fans and vents are not obstructed. Wherever possible, keep the equipment out of direct sunlight.

Do not place the equipment in an unstable condition where it might accidentally fall over.

Make sure that the mains voltage and fuse rating information of the equipment will be visible after installation.

### Electric fields

#### Caution:

**In accordance with Part 15 of the FCC Rules & Regulations, "... changes or modifications not expressly approved by the party responsible for compliance could void the user's authority to operate the equipment."**

Should this product be used in an electromagnetic field that is amplitude modulated by an audio frequency signal (20Hz to 20kHz), the signal to noise ratio may be degraded. Degradation of up to 60dB at a frequency corresponding to the modulation signal may be experienced under extreme conditions (3V/m, 90% modulation).

### Optional equipment

Unless advised otherwise, optional equipment must only be installed by service personnel and in accordance with the appropriate assembly and usage regulations.

### Special accessories

To comply with part 15 of the FCC Rules, any special accessories (that is, items that cannot be readily obtained from multiple retail outlets) supplied with this equipment must be used with this equipment; do not use any alternatives as they may not fulfil the RF requirement.

## Making up a rack

If you are making up a rack, there are careful considerations to be addressed beforehand, which are outlined in this section.

### Outboard equipment racks

To ensure the correct installation and function of the outboard equipment, such as the DL251 Audio System I/O and DN9696 recorder, racks must meet the following general requirements.

- **Shock mounting (for non-installation environments):** The racks must provide adequate shock protection of the units they house by incorporating appropriately-designed shock protection methods, for example, a foam-suspended rack or a frame suspended on anti-vibration mounts etc.
- **Ventilation:** Midas rack units have been designed such that their internal ventilation airflow is drawn in through the front of the unit and expelled through the rear. To facilitate this, rack design must ensure that cool air can flow freely through the rack in the same direction, that is, in through the front of the rack and out through the rear. Situations where the air flows in a circular direction around and through a unit **must** be prevented. Midas recommends that racks with fully opening front and rear doors are used.

***Note:** Never combine units in the same rack that have been designed for a ventilation air flow direction other than that for the PRO2 units. To avoid this, we recommend that any non-PRO2 units are housed separately.*

- **Rack mount supports:** Always secure the rear of the units to the rack via their rear rack mount support brackets. These brackets are fitted to every PRO2 unit and are recommended for use in touring applications. The rack mount support fixing hole centres are at a depth of approximately 395 mm from the front panel (this dimension may differ slightly on the DN9696).
- **Handles on rack case:** You must ensure that there are sufficient external handles fitted to the rack casing to enable the rack to be manoeuvred easily and safely, and by the amount of personnel suitable for the task. Also, these handles must be fit for purpose.
- **Clearance at rear of units:** To ensure an adequate clearance at the rear of the units, we recommend that the rack depth, that is, the distance from the front rack strip to the rear of the rack, is a minimum of 700 mm.
- **Securing the cables:** We recommend that the cables at the rear of the units be tidied using lacing bars and cable ties. This should provide optimum access to the rear of the units for connecting other cables, switching the units on/off, etc., and give maximum visibility of the units' LEDs for determining communication status, link status, condition of audio etc.

## Connecting up

Connect your system according to your requirements. For examples of system configuration, see “System configurations” on page 8.

To ensure the correct and reliable operation of your equipment, only high quality, balanced, screened, twisted pair audio cable should be used.

XLR connector shells should be of metal construction so that they provide a screen when connected to the console and, where appropriate, they should have Pin 1 connected to the cable screen.





All Jack connector shells should be connected to the cable screen.

For more information, see the PRO2 Live Audio System - Set Up Guide (part number DOC04-DL2SUG1).

## Audio connections

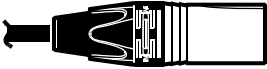
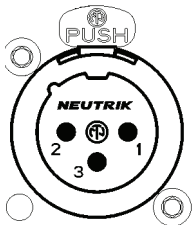

This section gives details of the audio connections of the PRO2 Control Centre.

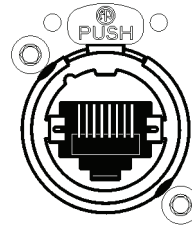
**Table 1: Connector pinouts**

<i>Connector on rear panel</i>	<i>Example of plug</i>	<i>Pinouts</i>	<i>Example of socket</i>
Male XLR chassis connector (output)		1 = ground 2 = hot 3 = cold	
Female XLR chassis connector (mic input)		1 = ground 2 = hot 3 = cold	
Ethernet EtherCon® connector		N/A	

**Other connections**

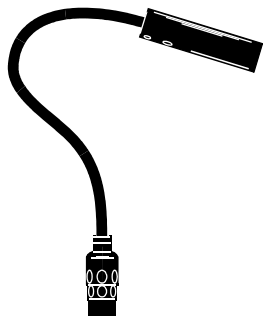
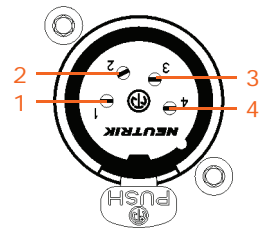
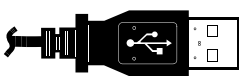
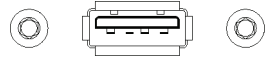
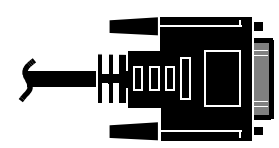
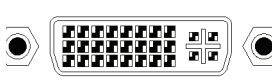
The section gives details of the other PRO2 Control Centre interconnections.

<i>Description</i>	<i>Example</i>	<i>Pinouts</i>	<i>Example of socket</i>
4-pin, male XLR chassis connector(s) on the rear panel for connecting 12V/5W lamp(s)		1 = N/A 2 = N/A 3 = ground 4 = 12V	
USB type A socket		N/A	
DVI screen output socket for connecting		N/A	
<b>foot switch</b> socket for connecting a 1/4" TRS Jack plug		1 (tip) = foot switch 1 2 (ring) = foot switch 2 3 (sleeve) = ground	

The **diagnostics** socket is for service personnel use only.

## Powering the PRO2 system

The internal power supplies are of the switch mode type that automatically sense the incoming mains voltage and will work where the nominal voltage is in the range 100VAC to 240VAC.

**!** Each mains inlet is to be sourced from its own separate wall-mounted mains outlet socket. Otherwise, their mains sources must be suitably distributed so as to meet local safety regulations.

**!** When removing the equipment's electric plugs from the outlets, always hold the plug itself and not the cable. Pulling out the plug by the cable can damage it.

**!** Never insert or remove an electric plug with wet hands.

**!** Before switching the PRO2 on/off, make sure that all monitor loudspeaker power amplifiers are turned off or muted.

The following details the recommended power up and power down procedures for the PRO2 system.

### >> To power up the PRO2 system

**!** DO NOT switch on the speaker sub-system until after the start-up of the PRO2 system has been completed.

After all PRO2 system interconnections have been made, start up the PRO2 system:

- 1 Make sure that all of the PRO2 system equipment is switched off, that is, the PRO2 Live Audio System, speaker sub-system and DL251 Audio System I/O.
- 2 Switch on the PRO2 Control Centre (see "To switch on the PRO2 Control Centre" on page 31).
- 3 On the PRO2 Control Centre, move all of the monitor and master channel faders to the minimum position and mute all of the master channels.
- 4 Switch on the DL251 Audio System I/O.
- 5 After the **status** LEDs (top of the GUI screen on the PRO2 Control Centre) turn green, switch on the speaker sub-system.
- 6 Switch on the audio source and start playing the audio.
- 7 On the PRO2 Control Centre, check that the audio inputs are routed to the master channels. Then, unmute the master channels and gradually increase their faders, while listening to the sound levels from the speakers.

If there are no sounds at all from the speakers when the faders are at maximum, move the faders to below the 0dB level and check if the audio is muted somewhere along the input paths and also check that the individual speakers are switched on. If there is still no sound from the speakers, contact Midas Technical Support.

### >> To power down the PRO2 system

**!** BEFORE switching off any of the PRO2 system components, make sure to mute the audio from the speakers and switch off the speaker sub-system.

- 1 Mute the audio from the speakers and switch off the speaker sub-system.
- 2 Switch off the DL251 Audio System I/O.
- 3 Switch off the PRO2 Control Centre (see "To switch off the PRO2 Control Centre" on page 31).



## Switching the PRO2 Control Centre on/off

Carry out the following to switch the PRO2 Control Centre on/off in a safe manner.

### >> To switch on the PRO2 Control Centre

**!** Before switching the PRO2 on, make sure that all monitor loudspeaker power amplifiers are turned off or muted.

After connecting up the audio cables, carry out the following:

- 1 Plug one of the control centre's mains cables into a mains power outlet and then connect the IEC plug to a mains inlet socket on the rear of the PRO2.
- 2 Do the same with other mains cable. **Make sure you connect the mains cable to a separate mains outlet.**
- 3 Make sure that all monitor loudspeaker power amplifiers are turned off or muted and then switch on both mains on/off switches, one after the other. **Do not switch them on simultaneously.**
- 4 The control centre will power up; the GUI will display the default screens and all the controls will be set to default. You are now ready to start using the PRO2 control centre.

### >> To switch off the PRO2 Control Centre

- 1 Make sure you have saved any shows, scenes or settings you require (see "Saving your show files to a USB memory stick" on page 91).
- 2 At the GUI, choose **home ▶ Preferences ▶ Shutdown System**.
- 3 At the **Shutdown ENTIRE system?** prompt, click **OK**. This initiates the shutdown down sequence.

During the shutdown sequence the GUI screens will shutdown and all of the LCD select buttons on the control surface will turn red.

When the shutdown sequence has finished the LCD select buttons on the control surface will turn green, and the appropriate ones will also display text messages, accordingly.

**!** During the shutdown sequence, when the LCD select buttons on the control surface are red, do not switch off the mains power supply, and when they are green, it is OK to switch off the mains power supply.

- 4 Make sure that the shutdown sequence has finished, and then switch off the mains on/off isolator switches (rear of control centre), one at a time.
- 5 Disconnect the two mains connectors from the sockets on rear of PRO2 Control Centre.



# *Basic Operation Of The PRO2*



## Chapter 5: Before You Start

This chapter provides useful background information on PRO2 operation.

While this system is a complex, high-tech piece of equipment, we have made it as easy to use and as user-friendly as possible.

### Principles of operation

PRO2 Control Centre operation is based on the concept of colours and groups rather than 'layering' or 'paging', which is the case with most digital consoles on the market today. With so many channels available it is far easier to remember them by their user-configured individual/group colour and name rather than their channel number.

The control surface is populated with instantly recognisable controls that are logically distributed in major sections, so that all the controls you need to access most of the time are always on the control surface, while the remainder are only one action away.

### Hints and tips

During operation, we recommend that you carry out the following:

- **Check what is hidden** On the PRO2, unlike on an analogue control surface, some of the settings and parameters will be hidden from view (stored in the computer memory of the PRO2). To make sure there are no hidden surprises, such as a reverb send left from a previous mix, we recommend that you view unused parameters at various times during a mix.
- **Check the Console Overview screen** It is a good idea to frequently monitor the **Console Overview** screen (press the **HOME** button underneath the GUI screen), which provides at a glance an overview of the control centre's status and operation. It shows all the meters and the status condition of faders and some switches, such as solos and mutes. However, some things will still remain hidden.

### Saving your work

We recommend that you save your work regularly while carrying out the procedures included in this chapter. Not only is this good practice during normal PRO2 operation, but in this instance it may save you from losing some set-ups that could prove useful later on. To do this, create a new show (see "To create a new show" on page 82), and then continue reading through the remainder of this section, following the instructions carefully. Save your work at convenient points (see "To create a new scene using the current settings" on page 84 and "To save a show or create a new one from the current settings" on page 83).

### Saving a show versus storing a scene

It is important to understand the differences between saving a show and storing a scene.

- **Storing a scene** saves the current settings of the system to the show file. Scene data is *never* updated to the show file unless you manually store a scene. The show file remains unsaved in RAM after storing a scene.

Although the state of the control centre is copied every five seconds, it is not stored in a scene. Instead, it is placed in the NVRAM (non-volatile random access memory) of the control centre's memory, which is a type of RAM that doesn't lose its data when the power goes off. If the control centre loses power accidentally, these settings are loaded so that audio parameters are identical, thus avoiding audio level jumps. **When power is lost, the showfile loaded (if any) will not subsequently be restored, and any unsaved changes to it will be lost.**

- **Saving a show** copies the show file onto the internal solid-state disk of the PRO2. This provides you with a 'permanent' copy, provided you shut down the system properly as detailed in the following section.

### Shutting down the PRO2 Live Audio System properly

When switching off the PRO2 Control Centre, we recommend that you use the shutdown option of the GUI menu (see "To switch off the PRO2 Control Centre" on page 31).

By using shutdown, the cached copy of the show data, which is maintained by the system, is automatically stored. Shutdown then uses the current showfile, NVRAM data and cache files to restore the PRO2 Control Centre to *exactly* the same state as at power down; even to the point of loading the unsaved show and placing you at the correct scene, with non-stored scene data at the control surface.

If you don't use the **Shutdown** option the audio parameters are still restored, but the show and show status (saved/unsaved) cannot be restored automatically. You must manually reload the show and any unsaved changes will be lost.

## Chapter 6: Working With The PRO2 Control Centre

This chapter is intended to familiarise you with the controls (control surface and GUI) of the PRO2 Control Centre.

Although many controls on the PRO2 Control Centre are similar to their equivalent analogue-type counterparts, some have been specifically designed for the PRO2, particularly those for navigation and GUI operation. As you will probably have had experience on analogue consoles, you will already be familiar with most of the PRO2 controls and their operation.





The GUI can be used to replicate most of the control surface functions and even has many of its own. However, the emphasis in this chapter — and throughout the manual — is on using the control surface because, generally, it is quicker and more intuitive. GUI methods will be included where they are anomalous or there is no control surface equivalent.



The navigational controls, such as quick access buttons and scroll buttons, are described in Chapter 7 "Navigation" on page 43, and the ones specifically for automation can be found in "Managing the scenes" on page 84.

For more information on the operation and function of specific controls, see Volume "Description" on page 225.

### About the PRO2 controls

The following table shows some of the controls that can be found on the control surface of the PRO2.

<i>Type</i>	<i>Description</i>	<i>Example(s)</i>
Pushbutton	Generally two-state, that is, on/off or enabled/disabled, and backlit or with an integral LCD for status indication.	 
Control knob	In general, the control knobs (rotary controls) are touch-sensitive, their adjustment being shown on the GUI. Some control knobs are backlit to help identify their current role.	
Fader	The high quality motorised faders are, similarly to the control knobs, touch-sensitive.	

Type	Description	Example(s)
LED	Status indication.	
Meter	All of the input, output and monitor peak level meters on the control surface are shown simultaneously on the GUI's <b>Console Overview</b> screen. Additional peak level meters are included in the direct input and direct output sections of the input bay and mix bay channel strips, respectively.	

## About GUI operation

The GUI is not just an additional feature that enhances control surface operation, it is a fully-featured tool in its own right. Not only does it show what is happening on the control surface, but all of its controls are functional. The GUI contains most of the controls found on the control surface and, in addition, has features that allow configuration of the PRO2 and provide extra functionality.

For information on how to operate the GUI (for example, using click and drag, using the **screen access** buttons), see PRO2 GUI Navigation in the PRO2 Live Audio System Quick Start Guide.

## GUI screen layout

The GUI screen has three distinct areas (shown right). The status bar is constantly displayed throughout console operation, while the main and detail areas are context-dependent and may be combined, particularly for GUI menu screens. During channel operation the main area will be divided into eight strips (fast strips) displaying the channels currently assigned to the channel faders at the control surface. The detail area shows a detailed view of the parameters of the currently selected channel section; with no channel selected the detail area will be blank.

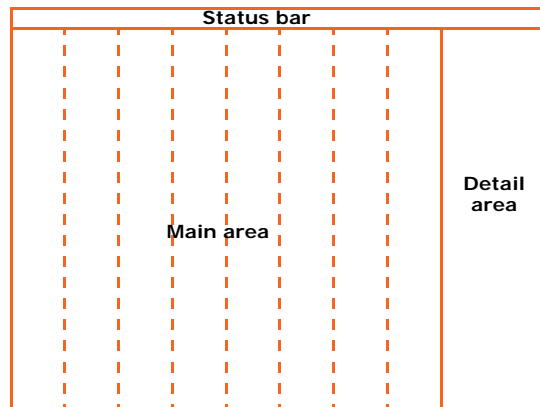

To distinguish between channel types, they are colour-coded: inputs = blue, aux inputs = dark green, aux sends = light green, matrix = black and masters = black.



**Status bar**

The Status bar, which is always displayed at the top of the GUI screen, contains a number of elements as shown in the following diagram.

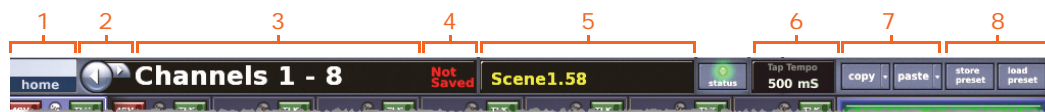

<i>Item</i>	<i>Description</i>
1	<b>home</b> button, opens the GUI menu (see “GUI menu flowchart” on page 284).
2	Screen navigation buttons (see “To find a GUI screen that you recently opened” on page 46).
3	Name of current screen.
4	“Not Saved” message appears when the scene/preset library file contains changes that have not been saved.
5	Title of currently selected scene, if any.
6	<b>Tap Tempo</b> section, which shows the current tap tempo time (ms).
7	Copy and paste buttons (see “Using copy and paste” on page 87).
8	User library buttons (see “User library (presets)” on page 88).

**GUI cross-hair**

The GUI uses a ‘cross hair’ configuration (shown right) to show which channel is currently selected in the channel fader section and also its current detail area selection.

The detail area can show an output, while the main area displays input channel overviews, and vice versa.

You can navigate the eight channel faders to show output channel overviews.

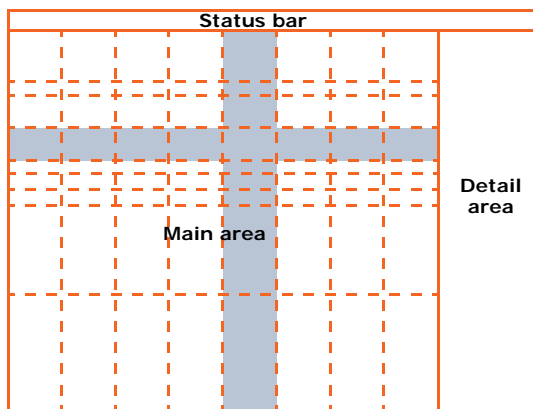

## Parameter values displayed on touch

You can configure the PRO2 (see “Setting the user interface preferences” on page 209) so that the GUI displays the current value (and dimension) of the control being adjusted.

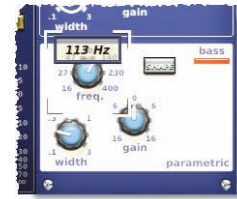

If you adjust an aux via the **mixes** section of an input fast strip, the current value will be shown in the aux's panel of the GUI input fast strip.



## Operating the GUI screen controls

This section shows you how to operate GUI screen elements, such as buttons, control knobs, drop-down lists and sliders.

### >> To switch a GUI button on/off

Click the button. If it has a status indicator, this will illuminate/extinguish to show that it is on/off, respectively.

### >> To adjust a GUI control knob or fader

Use a drag operation. Move the pointer up/down/left/right for adjustment.

## Using drop-down lists

Certain configurable name fields, particularly the signal routing ones, have drop-down lists that offer a number of preset or context-sensitive options to choose from. Long lists — containing more options than can be displayed simultaneously — have sliders that allow you to access all of the options.

### >> To select an option from a drop-down list

- 1 Click the drop-down arrow. The drop-down list will unfold to display some or all of its contents, depending on how many items it contains.
- 2 Do one of the following:
  - Click the option you require.
  - If necessary, scroll the list (see “To scroll a drop-down list” below) to display the option, and then click it.

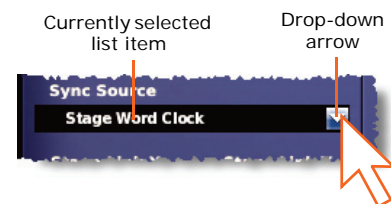

>> **To scroll a drop-down list**

With the drop-down list displayed, do one of the following:

- **A** — Drag the scroll box.
- **B** — Click the scroll bar. The scroll box will 'jump' in the direction of the click to another position in the scroll bar.
- **C** — Click an up/down scroll arrow. The scroll box will 'jump' in the direction of the scroll arrow to another scroll bar position.

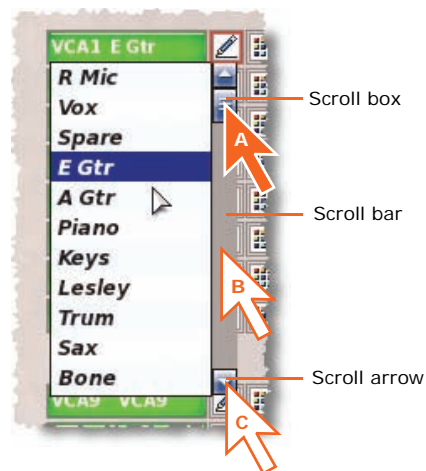

**Spin buttons**

Up/down spin buttons (highlighted right) let you increase/decrease the attribute or value of an item. For example, the amount of time a signal is delayed.



**Radio buttons**

Radio buttons let you choose a single option from a list of options.



**About windows**

There are three main types of window you will encounter when using the GUI:

- **Parameter** windows contain elements (parameters) that you can select or edit, such as options, lists, tick boxes, text fields etc.
- **Alert** windows contain text that can be a prompt or an error message. Generally, this type of window will contain a user-editable text field and **OK** and **CANCEL** buttons. [All controls inhibited until a button - CANCEL or OK - is pressed.]
- **Option** windows have a number of user-selectable options in the form of a list, and may include **OK** and **CANCEL** buttons.

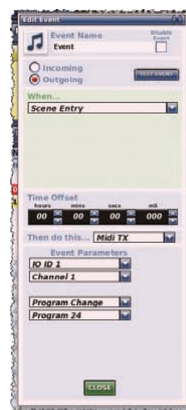

Properties window

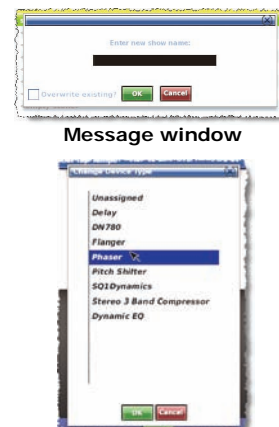

List window

Similar to a window found on a PC running a Windows-based operating system, the window can be moved around the screen, which is useful if you need to see what is behind it. Also, each window has a close (X) button at its upper-right corner.

>> **To close a window**

Do one of the following:

- To acknowledge your changes, click **OK**.

- To cancel your changes, click **CANCEL**.
- Click "(X)" at the upper-right corner of the window.

### >> To move a window

Use drag, by clicking on the window's blue bar (top) and dragging the window where you want it.

## Graphs

Some graphs, such as the crossfade and surround spatial diagram (shown right), can be edited on the GUI using drag.

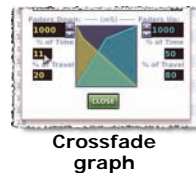

Crossfade graph



Surround spatial diagram

## Using the GUI menu

The GUI main menu (shown right) is opened by clicking the **home** button, which is constantly displayed at the upper-left corner of all GUI screens. To select a submenu option, move the pointer over the arrow to the right of the menu option (the submenu will open automatically to the right of the arrow) and choose the option you want.

**Note:** Throughout this manual, menu/submenu option selection sequences are shown in the following format: **home ▶ Preferences ▶ General** (for example, for choosing the general preferences screen).

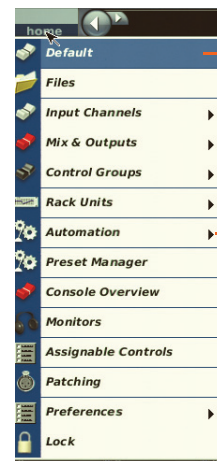

Blue background shows that option is ready for selection

Right arrow shows that the option has a submenu

## Text editing

For text editing on the GUI (for example, to configure input and output channel names) you need to attach the supplied external USB keyboard (see "Rear panel connections" on page 227). You can also use the navigation zone to help you (for example, by highlighting portions of text using drag).

### >> To enter/edit text via the keyboard

- 1** At the GUI, click within the desired text box. This will place an insertion point in it; the pointer will change to an I-beam shape.
- 2** Using the keyboard, edit/type in the new text. Any existing text can be edited or deleted using the right-click cut, copy and paste options.
- 3** On the keyboard, press **ENTER** to exit the text box (or click on an empty area of the GUI screen). The pointer will change back to an arrow shape.

## Chapter 7: Navigation

This chapter introduces you to PRO2 navigation and shows you how to use the navigational tools of the PRO2 Control Centre to navigate its channels, groups and buses.

For information on other types of PRO2 navigation, refer to the following:

- To navigate the scenes in automation, see "Managing the scenes" on page 84.
- To open the GUI's **Patching** screen, see "Navigating to the Patching screen" on page 16.
- To navigate the assignable controls, see Chapter 19 "Assignable Controls" on page 153.

### An introduction to PRO2 navigation

The PRO2 provides you with unique navigational controls to quickly and easily access the items, such as channels, buses, groups and detail areas, that you will require for mixing.

Navigation is an important feature of the PRO2 Control Centre. One of the advantages digital consoles have over analogue ones is that their channel count is not limited by the control surface hardware. However, this means that only a certain amount of channels can be at the control surface at any time, while the others are 'hidden'. So, navigation is required to access these hidden channels whenever you need them.

The PRO2 has advanced navigational functions that are explained in this chapter.

### Channel navigation

The channel fader section has eight channels. You can scroll (continuously) from inputs to outputs and vice versa, but only one type can be assigned to the control surface at any time. Channels are handled in banks of eight and are shown on the control surface and GUI in ascending order from left to right.

The following illustration shows the number of analogue consoles it would take to show all input channels all of the time, as shown in Figure 1 (a massive beast!).

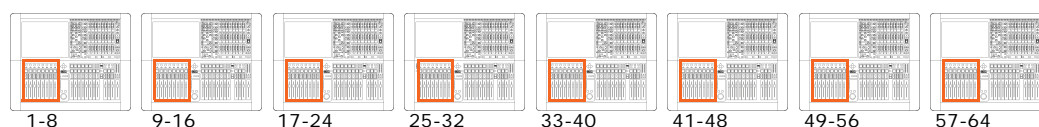

Figure 1: Theoretical analogue equivalent of the PRO2

The following is a list of the types of navigation available on the PRO2.

- Scrolling single channels
- Scrolling assignable control assignments
- Scrolling channels banks
- Swapping the assignable control button assignments
- Scrolling the mix buses

- Assigning input channels to the channel fader section
- Assigning output channels to the channel fader section
- Navigating the detail area assignments to the channel faders
- Assigning the mix bay as an additional fader bay
- Assigning VCA groups to the mix bay
- Assigning outputs to the mix bay

For more information, see the PRO2 Live Audio System Quick Start Guide.

## Advanced channel navigation

The console's advanced navigation mode switches can be locked out via the GUI menu (**home ▶ Preferences ▶ General ▶ User**), but if enabled these switches can be used to alter the behaviour of the console by defining what will be populating the mix faders if an output channel is selected. The mix faders can control:

- Main VCAs, and are then called VCA faders.
- Output channels, and are then called Output faders.
- Mix send VCAs, and are then called MCA faders.
- Output GEQs, and then called GEQ faders.

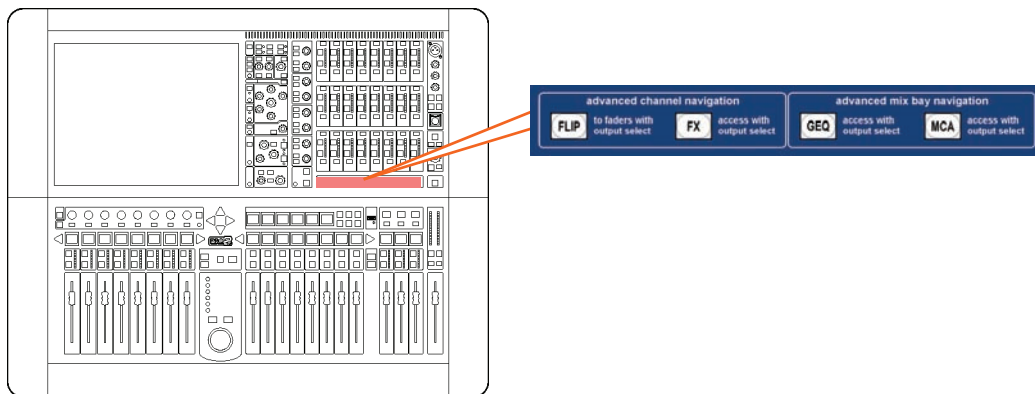

*Advanced navigation buttons on the control surface*

Advanced navigational functions include the following, which are detailed in the PRO2 Live Audio System Quick Start Guide. In addition to these is the collapsed flip function, which is detailed later on.

- **Flip mode (FLIP)** — channel faders become the mix send contributions to any selected output channel. Scrolling the detail area (the selected output) will result in scrolling of the flip sends. There is also a **FLIP** button on the GUI's **Console Overview** screen.
- **Opening the effects window on selecting an output (FX)** — when on and an aux send is selected, the effects processor that the aux is feeding appears on the channel overview GUI operated by the assignable control knobs.
- **Assigning GEQs to mix bay (GEQ)** — the mix faders also operate as GEQ faders, where they are scrollable in groups of four to access all 31 bands of the GEQ. The default starting frequency is 200Hz to 1kHz.
- **Assigning MCA groups to the mix bay (MCA)** — the mix faders can operate as mix control associates (MCAs), where the aux sends on multiple input channels have an associated master fader that provides overall control. This is similar to how a VCA fader operates on the main channel faders and MCA faders also have the same

names and channel members as the VCAs. For information on programming MCAs and VCAs, see “Configuring VCA/POPulation groups” on page 75.

### Collapsed flip

With collapsed flip enabled, switching flip on only recalls to control surface aux sends that are contributing to the selected mix output. Fader bay scrolling changes to banks of four.

This affects solo, such that any AFL solo is derived post- the aux send contribution level (and its pan if applicable).

#### >> To set up collapsed flip

- 1 At the GUI, choose **home ▶ Preferences ▶ General**. Then click the **User** tab to open the **Preferences User** screen (right).



- 2 In the User Interface section, click the Hide Unassigned Channels when Flipped selection box to tick it.



The console is now ready for collapsed flip operation.



## About GUI navigation

While the control surface provides instant, one-button access to many controls, the GUI provides an alternative way of navigating the PRO2 and offers some unique methods of its own. The GUI menu gives you access to all of the screens that you will need and you can even navigate backwards/forwards through the screens that you have recently opened.



*Don't forget that you can access some of the GUI screens directly by using the buttons in the **screen access** panel of the navigation zone.*

### >> To select a channel/group via the GUI

Click a non-control area of the channel. The local detail area will be assigned to the local channel strip (control surface and GUI).

### >> To select a channel/group using the GUI menu

At the GUI, do one of the following:

- To select an input channel, choose **home ▶ Input Channels**. Then, click the bank containing the input channel you want to open (for example, channels 9-16), and click the desired input channel (for example, IN14).
- To select an output channel, choose **home ▶ Mix & Outputs**. Then, click the bank containing the output channel you want to open (for example, Aux Sends 1-16), and click the desired output channel (for example, AS7).
- To select a VCA/POPulation group, choose **home ▶ Control Groups ▶ VCA Groups**. Then click a non-control area in the desired group (for example, VCA5).

### >> To assign a detail area to the output channel strip via the GUI

Click on one of the detail area panels in a GUI fast strip, making sure you avoid a control; see "GUI mix fast strips" on page 298.

### >> To find a GUI screen that you recently opened

Use the back/forward browser buttons to do one of the following:

- To return to the GUI screen you just opened, click the back button (as shown right).
- To open one of the GUI screens you have recently visited, click the back/forward buttons. The back button will take you back through your browser history, while the forward button goes the opposite way.



The back/forward buttons, which are always to the right of the **home** button, are similar to those on standard browsers found on any PC.



## Chapter 8: Patching

This chapter describes the patching function of the PRO2.

### Introduction

The patching function is fundamental to PRO2 operation as, until the I/Os have been correctly patched, you won't get any audio. Patching is done entirely at the **Patching** screen, which is an option in the GUI menu. This screen lets you carry out all the routing requirements of the PRO2 by providing an easy-to-use interface, where you can select your source and destination patching options, facilitated by a panel of function buttons. Additionally, the **Patching** screen lets you set up the DL251 Audio System I/O unit and any other devices. For example, you can adjust the analogue gain, select +48V phantom voltage etc.

### Terms used in PRO2 patching

- **Checkpoint:** A patching data store point, created by clicking **CHECKPOINT**.
- **Destination:** The patch connector to which a signal is routed.
- **Device:** A diagram on an I/O tab representing a physical rack unit, such as a line I/O, mic splitter, DN9696, AES50 etc.
- **Drag:** A method of selecting a block of source patch connectors in the **From** section of the Patching screen (see "To select a block of patch connectors in the From section" on page 65).
- **From section:** The left portion of the **Patching** screen, which contains the source patch connectors.
- **Patch connector:** A patching point on any of the tabs. For example, an XLR connector, bus, sidechain compressor, etc.
- **Patching:** The process of routing a channel/signal from a source to a destination(s).
- **Source:** The patch connector from which a signal is routed.
- **Tab:** A 'sheet' in the **From** and **To** sections that contains a specific group of patch connectors.
- **To section:** The right portion of the **Patching** screen, which contains the destination patch connectors.

### About the Patching screen

The **Patching** screen has two main areas: a function button panel towards the top of the screen and a patching area below. The function buttons provide the required patching functionality and allow I/O tab devices to be set up. The patching area provides access to all the patch connectors.

The patching area is split equally into two independent sections, called **From** and **To**, which contain the source and destination patch connectors, respectively. The patch connectors are grouped on tabs according to type. Only one tab per section will be visible at any time.

The I/O tabs represent the Stage (1 and 3) and FOH racks, and contain graphical representations (devices) of the units connected in those racks.

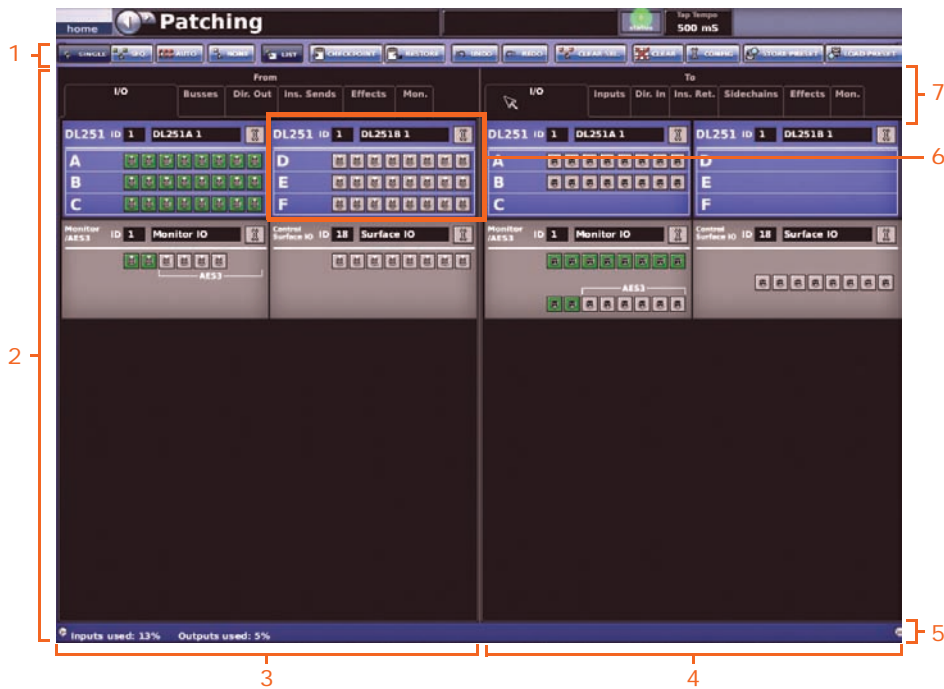

Figure 2: A typical Patching screen display

Item	Description
1	Function button panel, contains the function buttons that enable patching and device configuration (see “Patching screen function buttons” on page 49).
2	Patching area, contains all of the patch connectors on tabs.
3	<b>From</b> section, contains a number of tabs that house all of the patch connector sources (see “About the tabs in the From and To sections” on page 50).
4	<b>To</b> section, contains a number of tabs that house all of the patch connector destinations (see “About the tabs in the From and To sections” on page 50).
5	Status bar that shows the patching status of the inputs and outputs as a percentage.
6	A pictorial representation of a physical device.
7	Section titles and tab names.

### >> To open the Patching screen

Do one of the following:

- At the GUI, choose **home** ▶ **Patching**.
- Press the **routing / metering** button in the navigation zone.
- At the appropriate GUI screen, click the **src** (source) or **dest** (destination) button. The **Patching** screen will open at the appropriate tab/configuration window.















### Patching screen function buttons

The function panel buttons of the **Patching** screen are described in the following table. When a button is selected, its background colour changes to a lighter shade.

<i>Legend</i>	<i>Description</i>
<b>SINGLE</b>	Lets you patch a single source to a single destination or multiple destinations. See "Single patching (SINGLE)" on page 66.
<b>SEQ.</b>	Lets you select multiple sources and then patch them one by one to their destinations. With this method, each source can only have one destination. See "Sequence patching (SEQ.)" on page 66.
<b>AUTO</b>	Lets you select a block of sources and patch them all automatically in one go, simply by selecting a single destination. Any existing patches within the destination range will be replaced by the new ones. See "Automatic patching (AUTO)" on page 66.
<b>NONE</b>	Clears all currently selected patch connectors from all tabs in the <b>From</b> and <b>To</b> sections.
<b>LIST</b>	Changes the tooltip type from standard to list to help with sequence patching. This is only available when <b>SEQ.</b> is on (see "List tooltip" on page 59).
<b>CHECKPOINT</b>	Sets a patching store point, or snapshot, that contains the patching status at that instant. There is only one checkpoint available, so each time <b>CHECKPOINT</b> is clicked the previous checkpoint is overwritten.
<b>RESTORE</b>	Reverts patching status to the last checkpoint or, if no checkpoints have been created, it will revert patching status to the power up condition. All patching done in the intervening period will be lost.
<b>UNDO</b>	Undoes the latest single patch, even if it was part of a multiple patching operation. Repeated clicks will undo the preceding patching operations, going back to the last checkpoint, or power up if no checkpoints have been created.
<b>REDO</b>	Redoes an undo. This can be repeated for each undo in the previous undo operation.
<b>CLEAR SEL.</b>	Clears all current selections and their patches. <b>Important:</b> <b>Unlike the NONE button, which merely removes the current selections (highlighted in yellow), CLEAR SEL. goes a step further by removing the patch as well. This will stop any audio that may have been going through the patched signal.</b>
<b>CLEAR</b>	Clears all patching (see "To clear all current patching" on page 67). <b>Important:</b> <b>Exercise great caution when using this function. Observe the warning that appears after clicking this button.</b>
<b>CONFIG</b>	Opens the <b>AES50 Device Configuration</b> window, from where you can configure the device (see "The AES50 Device Configuration window" on page 62).

### What the Patching screen symbols mean

The following table gives a description of all the symbols that appear on the Patching screen tabs.

<i>Symbol</i>	<i>Description</i>
	During patching, this triangle appears under a tab name when its tab sheet contains a selected patch connector.
	Shown at the top of the channel patch connectors, this box aids channel identification by showing the channel's user-configured colour.
	Insert return patch connector.
	Insert send patch connector.
	Bus or channel source patch connector.
	Bus or channel destination patch connector.
	Female XLR chassis patch connector (input).
	Male XLR chassis patch connector (output).
	Jack patch connector.
	Non-functional patch connector, that is, one that cannot be patched.
	Compressor sidechain input patch connector.
	Gate input patch connector.
	DN9696 recorder patch connector.
	Set-up button, which opens the device configuration window (see "Configuring the devices" on page 60 for details).

### About the tabs in the From and To sections

The **From** section (left side of **Patching** screen) contains all of the source patch connectors on tabs, and the **To** section (right side of **Patching** screen) contains all of the destination patch connectors on tabs.

#### **Stage I/O tab — From**

The **Stage I/O** tab contains the devices fitted in the stage racks. For a typical display, see Figure 2 "A typical Patching screen display" on page 48.

**Busses tab — From**

The **Busses** tab allows routing from the auxes, matrices and master outputs.

This tab can also be accessed directly via the **dest** button in the **mixes** section of the input channels and in the **direct input** section of the output channels (see “Direct input controls” on page 304).

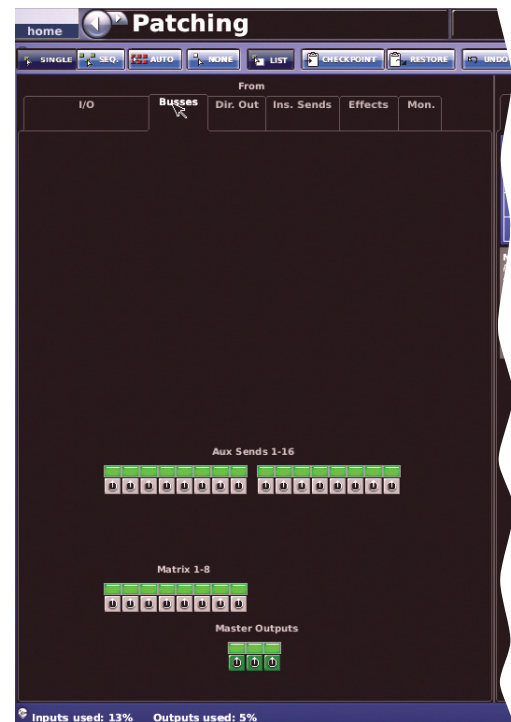
**Dir. Out (Direct Out) tab — From**

The **Dir. Out** (Direct Out) tab allows you to patch any of the 96 input channels internally. For example, to an effect or to provide a way out of the DL251/DL252 Audio System I/O via a line I/O unit.

This tab can also be accessed directly via the **dest** button in the **direct output** section of the input channels.



***Ins. Sends (Insert Sends) tab — From***

The **Ins. Sends** (Insert Sends) tab allows any of the input and output channels to be routed, primarily to an effects device.

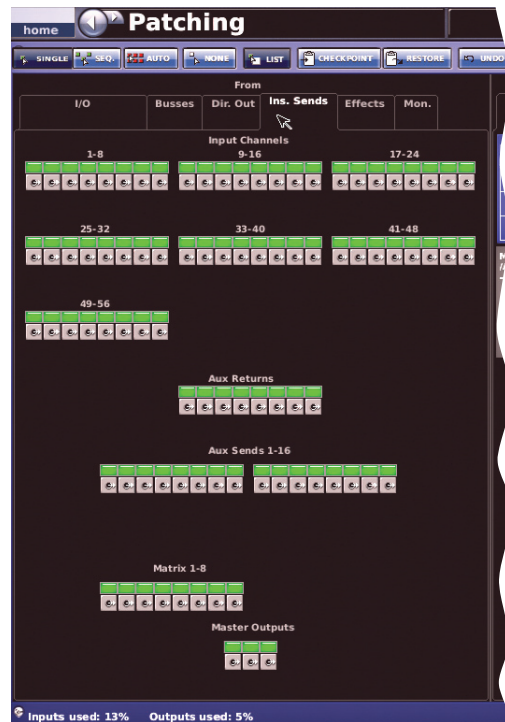
***Effects tab — From***

The **Effects** tab allows patching from any of the effects.

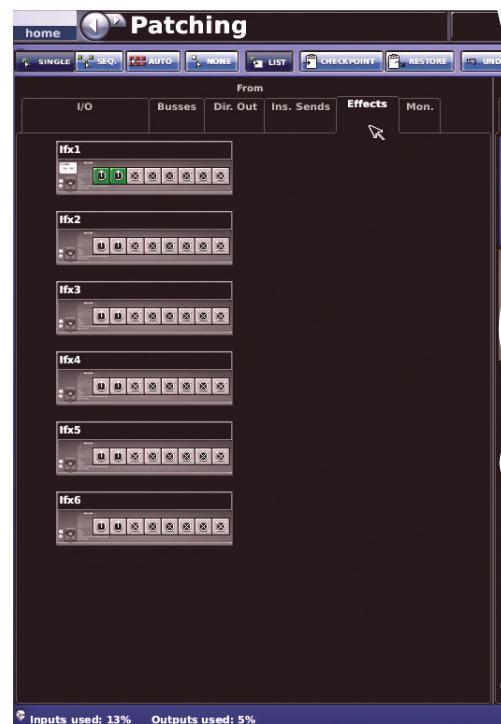

**Mon. (Monitor) tab — From**

The **Mon.** (Monitor) tab allows routing of the monitor outs and external talk destination.

This tab can also be accessed via the **dest** buttons on the Monitors screen.



<i>Mon. tab output</i>	<i>Equivalent on the Monitors screen</i>
Monitor Out A L	monitor A output L
Monitor Out A R	monitor A output R
Monitor Out B L	monitor B output L
Monitor Out B R	monitor B output R
Headphone Out L	N/A
Headphone Out R	N/A
External Talk Destination	external talk output

**I/O tab — To**

The **I/O** tab in the **To** section contains the devices fitted in the stage racks (except the mic splitters).

**Inputs tab — To**

The **Inputs** tab allows sources to be routed to the input channels and returns.

This tab is also accessed from the **src** button in the configuration section of the input channels.

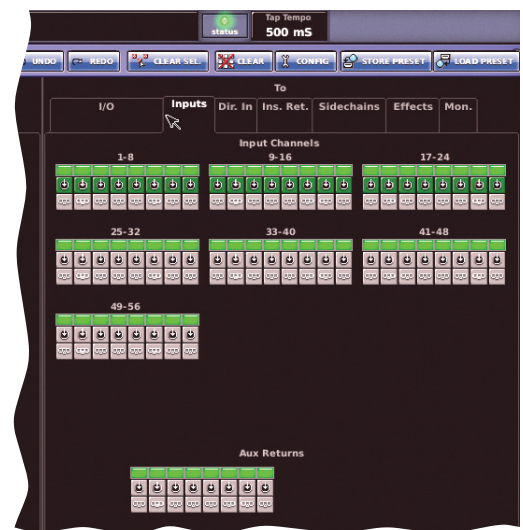



**Dir. In (Direct Input) tab – To**

The **Dir. In** (Direct Input) tab allows you to patch, for example, effects to the outputs.

This tab is also accessed from the **src** button in the configuration section of the output channels (see “Direct input controls” on page 304).

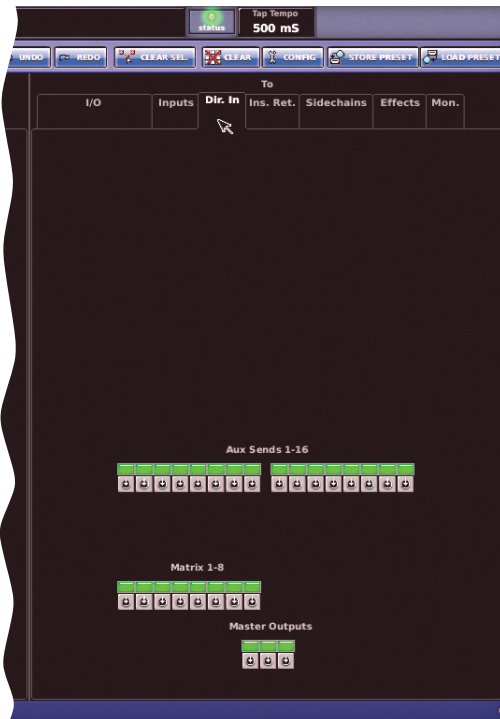
**Ins. Ret. (Insert Return) tab – To**

The **Ins. Ret.** (Insert Return) tab allows insert returns to be patched to any of the inputs and outputs.

This screen is also accessed directly via the **src** button in the insert section of both the input and output channels.

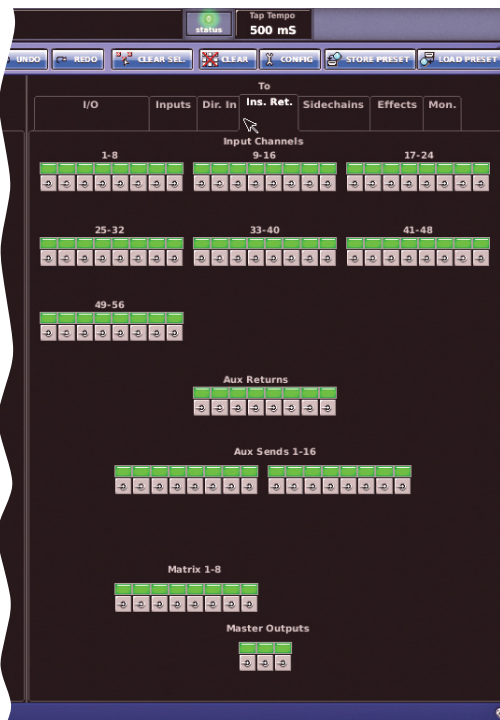



**Sidechains tab — To**

The **Sidechains** tab allows patching to the compressor and gate of the input and output sidechains.

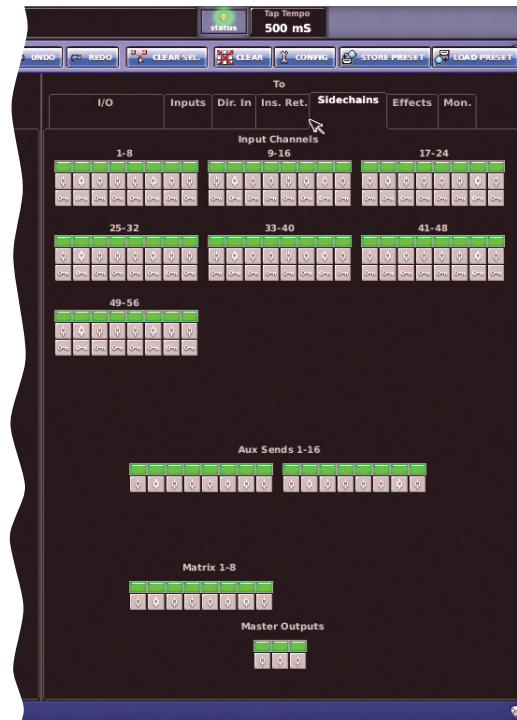

**Effects tab — To**

See “Effects tab — From” on page 52.

**Mon. (Monitor) tab — To**

The **Mon.** (Monitor) tab allows routing to the communications and monitors.

This tab can be opened using the **src** buttons on the Monitors screen.

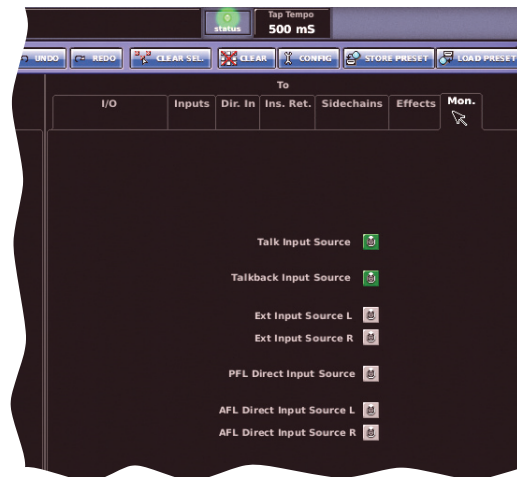

**Mon. tab input**

- Talk Input Source
- Talkback Input Source
- Ext Input Source L
- Ext Input Source R
- PFL Direct Input Source

**Equivalent on the Monitors screen**

- talk input
- talkback input
- external input L
- external input R
- pfl direct input

<i>Mon. tab input</i>	<i>Equivalent on the Monitors screen</i>
AFL Direct Input Source L	afl direct input left
AFL Direct Input Source R	afl direct input right





**Navigating to the Patching screen**





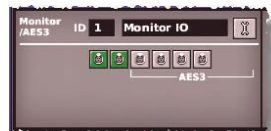

You can access the **Patching** screen from various other screens in the GUI menu, usually by clicking a **source** (source) or **dest.** (destination) button. When you click one of these buttons, not only will the **Patching** screen open, but the appropriate tab in the **From/To** section will be open as well. For a full list of patching routing on the PRO2, see “Navigating to the Patching screen” on page 16.

**About the devices on the I/O tabs**

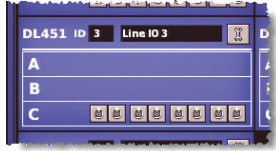
The following devices will, if selected (see “Setting up the I/O rack device(s)” on page 62), appear on the I/O tabs of the **From/To** sections of the **Patching** screen.

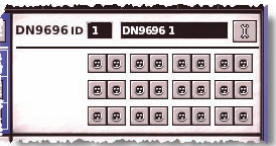
The device options in the following table are available for selection from the **device type** drop-down list in the **AES50 Device Configuration** window (see Figure 3 “The AES50 Device Configuration window” on page 62).

<i>Device type</i>	<i>Description</i>	<i>Diagram</i>
DL232A	One of three devices that comprise the DL232; the other two being “DL232B” and “DL321C”.	
DL251A	One of three devices that comprise the DL251 Audio System I/O; the other two being “DL251B” and “DL251C”.	
DL252A	One of three devices that comprise the DL252 Audio System I/O; the other two being “DL252B” and “DL252C”.	
N/A	<b>Control Surface IO</b> — represents the eight input and eight output connectors on the rear panel of the PRO2.	
N/A	<b>Monitor /AES3</b> — represents the AES3 I/O connectors on the rear panel of the PRO2.	

<i>Device type</i>	<i>Description</i>	<i>Diagram</i>
<b>Mic Splitter</b>	DL431 Mic Splitter.	
<b>Line IO</b>	DL451 Modular I/O.	
<b>Generic AES50</b>	Audio-only device that is used to represent the inputs and outputs of any third party AES50 device.	
<b>DN9696</b>	Klark Teknik DN9696 Recorder. Use up to four of these devices (with IDs 1 to 4) to represent the four AES50 ports for up to 96 channels of recording/playback. For more information, go to our website <a href="http://www.klarktechnik.com">www.klarktechnik.com</a> .	
<b>DL351A</b>	One of four devices that comprise the DL351 Modular I/O. The others are "DL351B", "DL351C" and "DL351D". For more information, go to our website <a href="http://www.midasconsoles.com">www.midasconsoles.com</a> .	
<b>DL351B</b>	See "DL351A".	
<b>DL351C</b>	See "DL351A".	
<b>None-Unknown</b>	Selects no device.	N/A
<b>DL351D</b>	See "DL351A". This is not displayed.	N/A

### Common device features

The device images have certain common features in their layout, as highlighted in the following diagram, which shows one of the I/O devices.

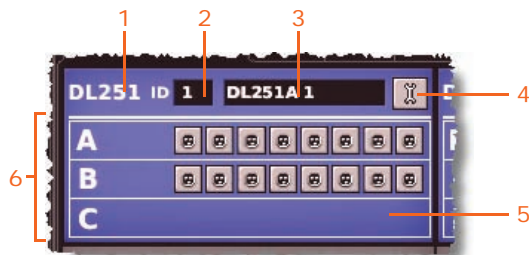

<i>Item</i>	<i>Description</i>
1	Unit type.
2	Unit ID number.
3	Unit name and PRO2-assigned unit number.
4	'Spanner' button, opens the device configuration window (see "Configuring the devices" on page 60).
5	XLR patch connector, which is male or female, depending on section location.
6	Patch connector area. (The line I/O device shows the three card slots, A, B and C.)

## Patching tooltips

Patching uses two types of tooltip — standard and list — to convey useful patching information about the patch connectors. A tooltip is a transitory object, in the form of a text box, that only appears while the GUI's pointer is in the proximity of a patch connector.

### Standard tooltip

The standard tooltip is the default type that appears during all patching operations. The following diagram shows, typically, the type of information provided by a standard tooltip.

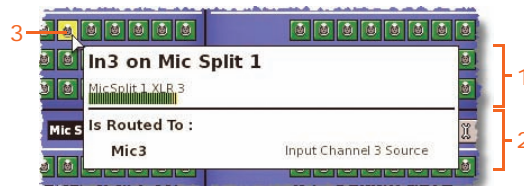

<i>Item</i>	<i>Description</i>
1	Patch connector information panel, contains information on the selected patch connector, such as, name, ID, device name, device ID etc. Depending on the device type, a signal level meter appears if the channel is passing audio.
2	Routing information panel, contains patching information on the selected patch connector. (If this panel is blank, the patch connector is not patched.)
3	The patch connector that the tooltip belongs to.

### List tooltip

If you are carrying out a sequence operation, you can use the list tooltip to help in selecting the destinations in the **To** section. This tooltip, which has a distinctive translucent orange background, displays a list of the sources still to be patched. The list is in order of selection, with the first in the queue being at the bottom. You can only use the list tooltip for sequence operations.



<i>Item</i>	<i>Description</i>
1	ID of the patch connector currently under the GUI pointer.
2	List of selected sources still to be patched. Contains channel and device ID information.
3	The source patch connector currently waiting to be patched. Once patched, this will disappear from the list and the one immediately above will become the next available.

**>> To select the list tooltip**

Press **LIST**. (Pressing **LIST** again will change the tooltip back to the standard type.)

## About the patching procedure

Although patching can be thought of as routing/rerouting the console's incoming, internal and outgoing signals, in the context of the **Patching** screen, patching also encompasses the setting up and configuration of the devices. The patching procedure is initially carried out after system installation (see Chapter 4 "Setting Up The System" on page 25 of the operator manual) and comprises:

- **Device configuration:** Configure the devices by adjusting their parameters as necessary (see below).
- **Setting up the I/O rack device(s):** Set up the system devices, such as line I/O and mic splitter, on the I/O tabs in the **From** and **To** sections of the **Patching** screen (see "Setting up the I/O rack device(s)" on page 62).
- **Patching:** Carry out all of the required routing, for example, mics to input channels (see "How to patch" on page 64).

## Configuring the devices

You have the option to configure the devices via the **Patching** screen. Parameters, such as gain and +48V phantom voltage, can be set via a device-specific configuration window.

These configuration settings can be independent of channel data, as (until patched) they only control the physical unit. If a device is subsequently patched to one or more channels, the channel(s) control the device, and vice-versa.

The device configuration window also allows control of audio parameters when the device is used as a direct connection to another device, for example, FOH to stage via a digital snake, instead of through the DSP. In this case the settings are also saved in the show file and can be automated, even though the signals are not routed through the control centre DSP.

As the mic splitter control conforms to the **DL431 Mic Splitter Inputs** options (**Use A Inputs** or **Use B Inputs**) in the **Configuration Preferences** section of the **Preferences** screen, it is not possible to control both the A and B settings on the mic splitter from a single console.???

## Device configuration procedure

The procedure for configuring a device comprises:

- Opening the configuration window of the device.
- Selecting one of the device's cards/channel ranges and configuring the available parameters.
- Repeating for the other cards/channel ranges of the device.
- Repeating for the other devices.
- Closing the device's configuration window.

**Note:** *The parameters available for a device are dependent on its type.*



**About the configuration window**

The configuration window, which has a similar format for each device, comprises eight channel panels and drop-down lists for channel range/card selection. A typical Line I/O configuration window is used in the following diagram to show the elements that are common to each device.



Item	Description
1	Device ID field, contains the device type and number.
2	Device drop-down list, for device selection. (Diagram shows the drop-down list selected.)
3	Channel range/card selection list.
4	<b>OK</b> button, saves the changes and closes the configuration window.
5	Channel panel, contains device-specific controls and graphics.

**>> To open the configuration window of a device**

Click the device's spanner button  (upper right corner of device).

**>> To set up/change the configuration of a device**

- 1 In the device configuration window, choose the device from the drop-down list. For example, the FOH line I/O device (ID11) connected to port 2.
- 2 From the drop-down list at the upper-right corner of the window, choose the card/channel. For example, the "AES/EBU Card".



- 3 In a channel, configure its parameters. For example, in channel "In1" adjust the gain and switch on the +48V phantom voltage (shown right).  
Repeat for the other channels in the card as necessary.
- 4 Repeat step 2 and step 3 for the other cards as necessary.
- 5 If necessary repeat step 1 to step 4 for any other devices of the same type.
- 6 Click **OK**.

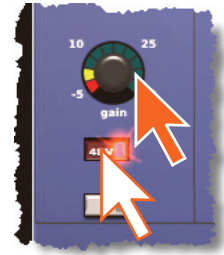

## Setting up the I/O rack device(s)

You can add, remove and set up the devices, such as line I/Os, mic splitters, DN9696s etc., that are connected to the Stage I/O and FOH I/O racks. This is done via the **AES50 Device Configuration** window (see Figure 3 "The AES50 Device Configuration window" on page 62), which is opened by clicking **CONFIG**. Here, you can set up the device's ID and also the type of cards (modules) fitted in the physical unit. Some of the device fields may be blank, as they are dependent on the device type.

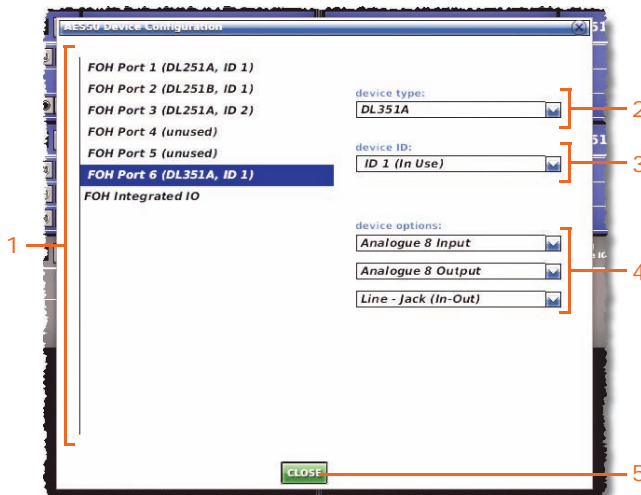

Figure 3: The **AES50 Device Configuration** window

Item	Description
1	List of Stage and FOH ports with current device assignments.
2	<b>device type:</b> drop-down list, contains a list of the available devices to choose from.
3	<b>device ID:</b> drop-down list, contains a full list of IDs for the selected device type. Those already in use will be prefixed with the text "(In use)".
4	<b>device options:</b> drop-down list(s) on modular I/O units only (for example, the DL351) from which you can select the card that is actually fitted in the physical unit. The positions of the drop-down lists are relative to the card positions in the physical unit.
5	<b>OK</b> button, closes the <b>AES50 Device Configuration</b> window.



### Device set-up procedure

The device set-up procedure comprises:

- Selecting the port (Stage or FOH) you wish to allocate the device to.
- Selecting the device type.
- Selecting an ID for the device.
- Selecting the options (if any) for the device.

#### >> To add a device or change its set up

- 1 Click **CONFIG**.
- 2 In the **AES50 Device Configuration** window, click the port you want to allocate the device to; these are listed in the far left of the window. For example, choose "FOH Port 3 (unused)". The text in the **device type:** field will change accordingly. Ports that don't have a device allocated to them it will have the text "unused" inside the brackets after their name.
- 3 In the **device type:** drop-down list, click the type of device. For example, choose "Line IO".
- 4 In the **device ID:** drop-down list, click the ID you want for the device. For example, choose "ID3".
- 5 In the **device options:** drop-down list(s), choose the type of each card fitted in the physical unit. For example, choose "Analogue 8 Input".

Repeat for any other cards.

- 6 Click **OK**.

#### >> To remove a device



Select the device from the list in the left of the **AES50 Device Configuration** window. Then, choose "None-Unknown" in the In the **device type:** drop-down list. For more information, see "To add a device or change its set up" above.

## How to patch

Patching, basically, involves selecting the source patching connectors in the **From** section of the **Patching** screen and then selecting their destination(s) in the **To** section. You can select patches singly, or in multiples by using the sequence and automatic operations.

### About the patch connectors

Each patch connector has three possible states, as indicated by its fill colour. The following table shows what each state signifies (the examples show XLR connectors, although it applies to any type of patch connector).

<i>Symbol</i>	<i>Description</i>
	Patch connector is neither selected or patched.
	Patch connector is selected, but can be in either a patched or unpatched condition.
	Patch connector is patched, but not selected.

### Working with patch connectors

You can select patch connectors one at a time by clicking on them, or you can select them in blocks by using a drag operation. All of the patch connectors in both the **From** or **To** sections are on tabs so, before you can select a patch connector, its tab must be open.





#### >> To open a tab in the From or To sections







Click the tab title. For example, **Ins. Sends** (insert sends).

#### >> To select a single patch connector

Click the patch connector. The effects of clicking a patch connector are shown in the following table.

**Table 2: Effects of clicking a patch connector**

<i>Click</i>	<i>To do this in the From section</i>	<i>To do this in the To section</i>
	Select the patch the connector (  )	Will do one of the following (provided a source patch connector(s) has been selected in the <b>From</b> section): <ul style="list-style-type: none"> <li>• Select the patch connector () during a single patching operation.</li> <li>• Patch the patch connector () during either a sequence or an automatic patching operation.</li> </ul> Otherwise, this has no effect.

Click	To do this in the From section	To do this in the To section
	Deselect the patch connector, which then reverts to its previous state (patched  or unpatched  ).	Remove the patch (  ).
	Select the patch connector (  ) and all the ones it is patched to in the <b>To</b> section. (A green triangle under a tab title shows that its tab contains one or more selected patch connectors.)	Remove the patch (  ).



*To quickly check the destinations of a source patch connector, click it. This will select it and all of its destinations. A green triangle will appear under the name of any tab in the **To** section that contains a destination(s).*

### >> To select a block of patch connectors in the From section

Use a drag operation to create a bounding box around the desired connections (typically shown right).

This procedure can only be done during sequence and multi-patching operations (initiated by the **SEQ.** and **AUTO** buttons, respectively).



### >> To deselect all selected patch connectors

Click **NONE**.

### >> To remove a single patch

In the **To** section, click the patch connector from which you want to remove the patch.

### >> To remove all the patches of a single source

- 1 Make sure that no patch connectors are selected. If necessary, click **NONE**.
- 2 In the **From** section, click the source patch connector from which you want to remove all of the patches. (This will select the source patch connector and also all of its destinations.)
- 3 Click **CLEAR SEL.**

### >> To remove the patches from all selected patch connectors

Click **CLEAR SEL.**

### >> To clear a block of patch connectors

- 1 Click **NONE**.
- 2 In the **From** section, select the patch connectors you want to unpatch.
- 3 Click **CLEAR SEL.**
- 4 Click **NONE**.

### Single patching (SINGLE)

The **SINGLE** function button allows you to patch a single source to a single destination or multiple destinations.

#### >> To patch a single source to a single destination

The following example shows you how to patch an output from a mic splitter to an input channel.

- 1 Click **SINGLE**.
- 2 In the **From** section, click the source patch connector. For example, choose the first patch connector of a mic splitter. Its background will change to yellow and a green triangle will appear under the tab title.
- 3 Click the destination patch connector. For example, in the **Inputs** tab of the **To** section, choose input channel 3 (Mic3). It will now be patched to the source. If the new patch is carrying a signal, this audio may be heard, depending on the settings of the DL251/DL252 Audio System I/O.
- 4 Click the source patch connector (**From** section) again to complete the patch.

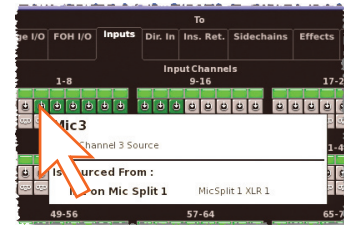
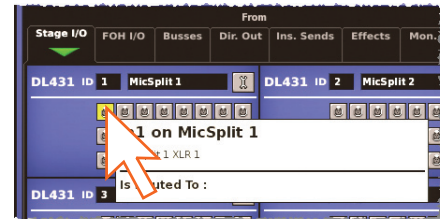

This can also be done by starting another single patch operation or by selecting another destination patch connector in the **To** section.

**Note: Note:** You can also carry out single patching operations using the **CLEAR SEL.** and **AUTO** functions.

#### >> To patch a single source to multiple destinations

- 1 Patch the source patch connector to its first destination (see "To patch a single source to a single destination" on page 66).
- 2 In the **To** section, select the other destinations.

### Sequence patching (SEQ.)

If you need to do a number of patches, and each has only a single destination, you can use the sequence function by pressing **SEQ.** All of the source patch connectors are selected in the **From** section before patching them, one by one, in the **To** section. This saves you having to go back to the **From** section for the start of each patch. You can change the tooltip to the list type by clicking the **LIST** button (see "Patching screen function buttons" on page 49) to help you.

### Automatic patching (AUTO)

You can patch a block of source patch connectors, just by selecting a single destination. This is called "automatic patching". When using automatic patching, note the following:

- Sources are selected in blocks (see "To select a block of patch connectors in the From section" on page 65).
- You can only select one block of sources.
- Destinations are restricted to a single type.

- The selected destination forms the start of the automatically patched range of destinations.
- Sources and destinations are automatically patched in ascending order, the lowest numbered source and the selected destination forming the first patch.
- Sources will only be patched up to the highest numbered destination of the current destination type. If there are any sources left over, automatic patching pauses. You can then patch these by selecting another destination.

#### >> To automatically patch a block of source channels

- 1 Click **AUTO**.
- 2 In the **From** section, select the source patch connectors (see "To select a block of patch connectors in the From section" on page 65).
- 3 In the **To** section, choose the destination patch connector that will form the start of the patched range. For example, input channel 3 (Mic3).
- 4 Click the destination patch connector. The sources will be patch in numerical sequence and in ascending order from here onwards.



#### Clearing all current patching

- ! The **CLEAR** function button clears all current patching, and must be used with great caution. To alert you of the drastic nature of using this button, a **WARNING** appears.

#### >> To clear all current patching

- 1 Click **CLEAR**. The **WARNING** window (shown right) will appear.
- 2 Heed the warning and do one of the following:
  - If you want to clear all current patching, click **OK**.
  - To cancel the clear operation and close the **WARNING**, click **CANCEL**.

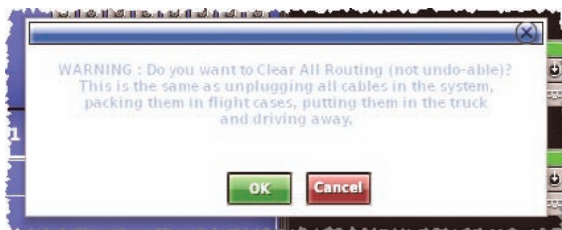



## Chapter 9: Basic Operation

This chapter is intended to familiarise you with the PRO2 Control Centre by showing you how to carry out some basic operations in order to get some audio out of it.

### Setting a mic amplifier's input gain

The PRO2 Control Centre has two input gains per channel, one is the remote gain for the analogue mic pre (stage box gain) and the other is the digital trim (console gain). In its default state, the stage box gain is in the channel strip and the console gain is in each input fast strip. However, you can swap these sections over (by using the **gain swap/[SWAP]** button) to give you a more global control of the stage box gain.

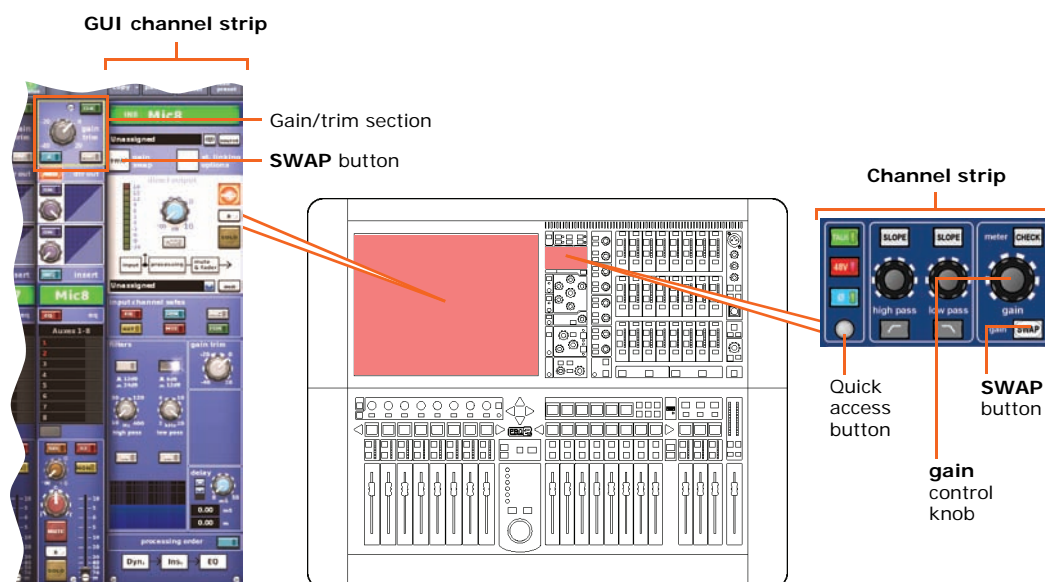

Figure 4: Gain and filters sections of the input strip

**Note:** The **gain trim** control knobs in each input fast strip will adjust whatever has been 'swapped' to their respective strips. The **stage box** control knob in the input channel strip always controls the alternative 'swap' to the ones shown in the GUI input fast strips.

#### >> To set the gain of the stage box/console

- 1 In the **gain trim** section of an input fast strip, press the quick access button. This selects the input channel and assigns its configuration detail area to the GUI channel strip (shown above), which contains the **SWAP** (gain swap) button.
- 2 Press the **SWAP** button. This swaps console digital trim to stage box input gain (and vice versa). The diagram right shows the two types of gain that can appear in the input gain/trim section at the top of each GUI input fast strip.





- 3 Adjust the **gain trim** control knob to set the stage box input gain. Range is shown on the GUI.  
Adjust level to suit the Midas pre-amp characteristic; a suitable level could be one that only just illuminates the yellow LEDs. Drive the mic amps for that 'Midas colouration' — feel free to overdrive if you want.
- 4 After you have achieved the required gain state, press the **SWAP** button again to swap back to console digital trim.
- 5 Adjust the **gain trim** control knob to set the console digital trim (gives +20dB to -40dB continuous trim) for preferred gain structure.
- 6 Set analogue remotes for initial set-up, then adjust digital trim for showtime.

## Setting the high and low pass filters

When switched in, the high and low pass filters have two settings each, selectable via their respective **SLOPE** button. These filters can also be set via the GUI.

### >> To set a filter

- 1 In the **gain trim** section of an input fast strip (see Figure 4, "Gain and filters sections of the input strip," on page 69), press the quick access button. This selects the input channel and assigns its configuration detail area to the GUI channel strip (shown above), which contains the **filters** section.
- 2 In the **filters** section of the input channel strip, press the filter select button (**high pass**  or **low pass** ) to switch the filter in.
- 3 If necessary press the filter's **SLOPE** button to set its slope (dB); its status is shown on the GUI. For the high pass filter, in = 24dB and out = 12dB, and for the low pass filter, in = 12dB and out = 6dB.
- 4 Adjust the **high pass/low pass** control knob to set filter frequency (Hz). The ranges are 10Hz to 400Hz for the high pass filter and 2kHz to 40kHz for the low pass filter.

### Important:

**Stage box hi pass — the remote stage box contains a 12dB/Oct 30Hz filter. It is recommended that this is used at all times for optimum A/D performance. However, it may be bypassed if extremely low frequency performance is required, for example, when testing the system.**



## Input equalisation (E zone)

Use EQ to equalise the input signal via the treble, hi-mid, lo-mid and bass filters, which are in the input channel strip's E zone. Treble and bass each have a parametric filter option with three specific shelving modes. Visual feedback for EQ is via GUI screen only, which also has a graphical representation of the filter.

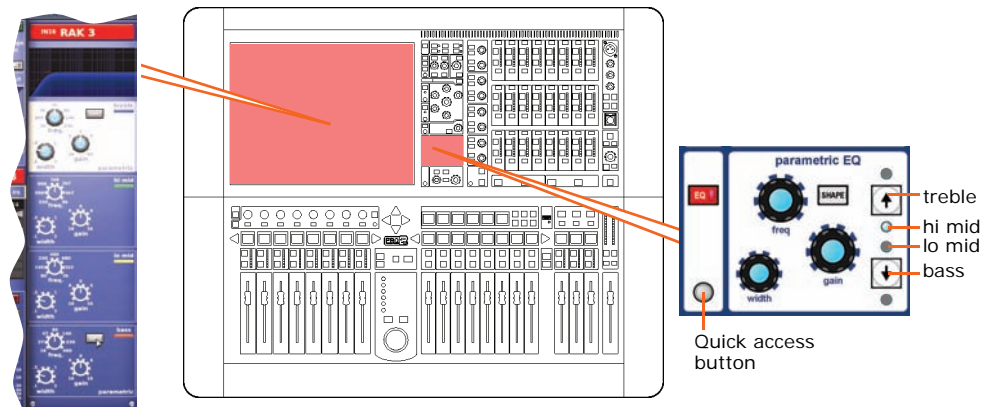

### >> To EQ the input signal

- 1 In the desired input fast strip, press **EQ** to switch the EQ in. This also selects the channel and assigns the EQ detail area to the GUI channel strip.
- 2 Do one of the following to select the EQ band:
  - In the input fast strip, press the quick access button of the desired band.
  - In the E zone, press the **treble/bass** up/down arrow buttons until the button/LED of the desired band is illuminated.

On the GUI the currently selected EQ band will have a light coloured background. For example, **treble** in the above diagram.

- 3 In the E zone, adjust the **freq**, **width** and **gain** control knobs to apply EQ as desired.
- 4 If you have selected **treble** or **bass**, press **SHAPE** (E zone) to cycle through the different shelving modes so that you can audition them. These are the 'minimum harmonic disruption' types, which are only available for **treble** (bright, classic and soft) and **bass** (deep, classic and warm). For example, the **bright** shelving mode of the **treble** band (shown right) as displayed on the GUI.

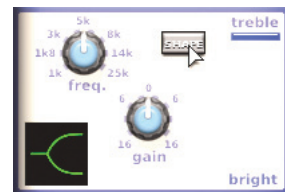

Alternatively, you can click the desired **SHAPE** button in the GUI channel strip.

**Note:** **bright** and **deep** use psychoacoustic phenomena to generate steep slopes that sound natural. These filters are called "minimum harmonic disruption filters".

## Input dynamics processing (D zone)

This section deals with assigning compressor and gate dynamics processors using the controls in the input channel strip's D zone. There are four compressors available — corrective, adaptive, creative and vintage — each with the option of hard knee, medium knee and soft knee (see Appendix A "Application Notes" on page 289). Visual feedback for both compressor and gate is provided by meters in each input fast strip, the dashboard screen and just above/below the graph, which gives a representation of the compressor/gate action.

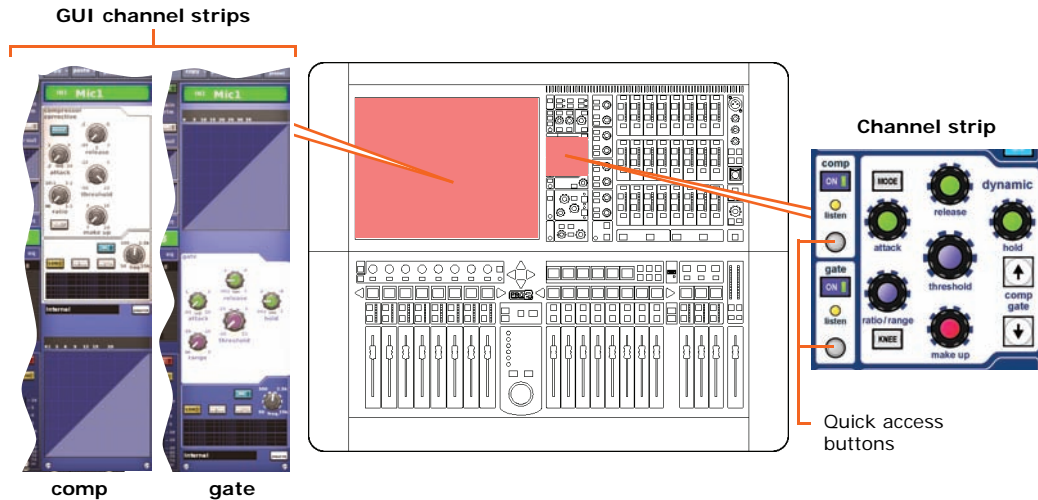
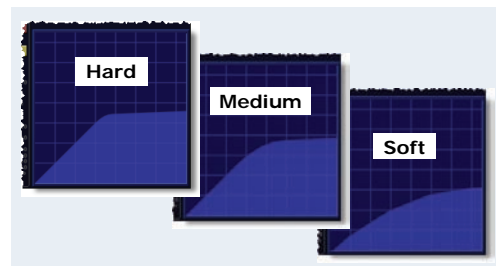

Figure 5: Compressor and gate channel strips

### >> To set up a compressor/limiter

- 1 Select the desired input channel.
- 2 In the channel strip, press the quick access button in the **comp** section (see Figure 5 "Compressor and gate channel strips" above) to select the input channel's compressor detail area.
- 3 Press **ON** in the **comp** section to switch the compressor in.
- 4 Operate the **attack**, **ratio/range** (ratio), **release**, **threshold** and **make up** control knobs (**hold** has no effect) to apply processing. See "Compressor" on page 250. You can set up a limiter by using a high threshold and a steep ratio (greater than 5:1).
- 5 Press **KNEE** to audition the different algorithms (hard knee, medium knee and soft knee). The effects on the signal are shown right.



- 6 Press **MODE** to try the different compressor types (**Corrective**, **Adaptive**, **Creative** and **Vintage**). For example, Creative (shown right).



>> **To set up a gate**

- 1 Select the desired input channel.
- 2 In the channel strip, press the quick access button in the **gate** section (see Figure 5 "Compressor and gate channel strips" on page 72) to select the input channel's compressor detail area.
- 3 Press **ON** in the **gate** section to switch the gate in.
- 4 Operate the **attack**, **ratio/range** (range), **release**, **threshold** and **hold** control knobs (**make up** has no effect) to apply processing. See "Gate" on page 254.

## Output processing

All outputs — except for the returns — have a six-band PEQ with shelving modes on bands 1, 2 and 6, and have the option of using a GEQ (accessed via a **GEQ** button in GUI channel strip). The returns have a similar EQ to that of the inputs channels.

The outputs (except returns) have five compressor modes, which include all of the ones on the input channels, but with the addition of a shimmer mode. The returns have the same compressor modes as those of the input channels.

## Using VCA/POPulation groups

VCA and POPulation groups allow simultaneous adjustment of a number of channels. Being instantly recognisable, they provide a quick method of bringing particular channels to the control surface and save you having to remember their name/number.

You can choose channel group associations and also configure the colour and legend of each group's LCD select button, which is used for group member assignment and recall.

VCA groups include fader, solo and mute control, whereas POPulation groups merely bring a group of input channels to a desired area of the control surface for viewing or adjustment.

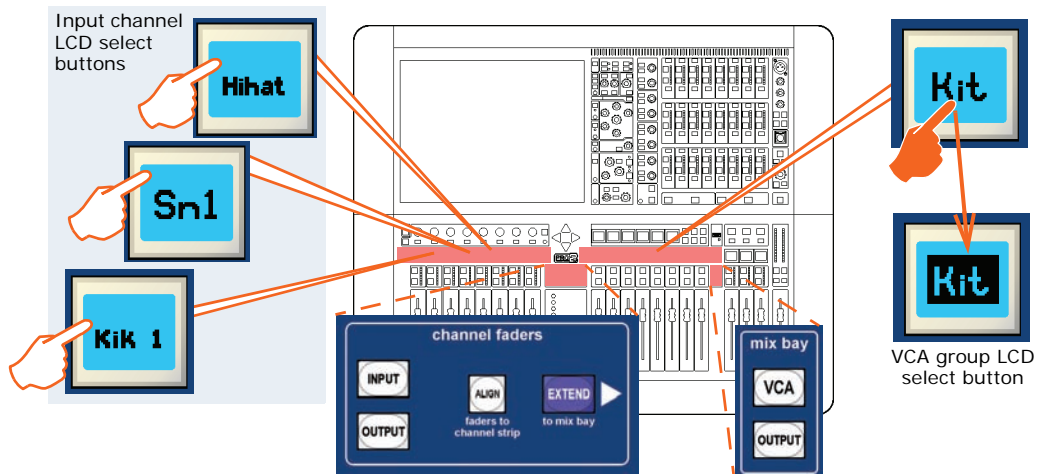

Assigning VCA group members

### >> To assign channels to a VCA/POPulation group

- 1 If necessary, assign the VCAs to the mix bay by pressing **VCA** in the **mix bay** section.
- 2 In the mix bay, press and hold down the LCD select button of the desired VCA. For example, a VCA group named "Kit". The button will start flashing when you are in group member selection mode and the inputs will jump to programme mode.
- 3 While still holding down the LCD select button of the VCA, press the LCD select buttons (just above the channel faders) of the channels that you want as group members. For example, "Kik 1", "Hihat" and "Sn1". If necessary press **INPUT** (**channel faders** section) to assign the input channels to the channel faders and/or scroll to a new channel bank.



*The first three selected channels of a group will comprise area B during two-man operation. For more information, see "Area B operation" on page 90 and Chapter 17 "Control Groups" on page 143.*

- 4 Release the group's LCD select button. The group now contains the input channels you have just chosen and the group will be selected.
- 5 Press the VCA's LCD select button again to exit the group.



*To quickly see which channels are in a particular VCA group, press its **SOLO** button on/off. Monitor this action on the **Console Overview** screen. Only the **SOLO** buttons of channels that are group members will be affected.*

## Configuring VCA/POPulation groups

The default name and associated colour of a group, which appear on its LCD select button and on the GUI, can be configured to suit your own preference. You can also globally change the colour of the group members to match the group colour. Configuration is done via the **Group Sheet** screen (shown below).

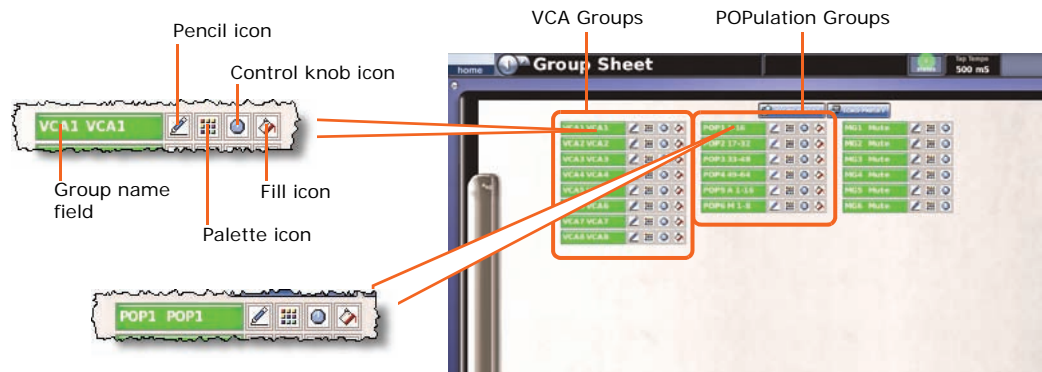

**Note:** Clicking the control knob icon  opens the **VCA Groups** screen (a submenu of the **Control Groups** option), which provides group management control.

### >> To access the Group Sheet screen

Do one of the following:

- At the GUI, choose **home** ▶ **Control Groups** ▶ **Group Sheet**.
- In the navigation zone, press the **vcas** screen access button.

### >> To set up the name of a VCA/POPulation group

Do one of the following:

- **Choose from a list of pre-configured names** Click the pencil icon  of the group. Then, choose the name from the drop-down list. For example, choose "E Gtr".
- **Type in a new name** Click within the name field of the group and then follow "To enter/edit text via the keyboard" on page 42.

### >> To set up the colour of a VCA/POPulation group

- 1 Click the palette icon  of the group.
- 2 In the palette (shown right), click the colour you want. For example, choose blue.



### >> To change the colour of all of a group's members to match that of its VCA/POPulation group

Click the fill icon  of the group. For example, if the colour of the VCA/POPulation is blue all of its group members will now be blue.

## Setting up a mix

The PRO2 has 24 configurable mix buses, each of which can be aux mixes, subgroups or mix minus. The aux mixes can also be set up as stereo pairs (restricted to like-coloured buses) or mono. To keep the control surface manageable, access to these mixes is confined to the **mix** section in the channel detail area, which can be scrolled up and down on a 'virtual' surface.

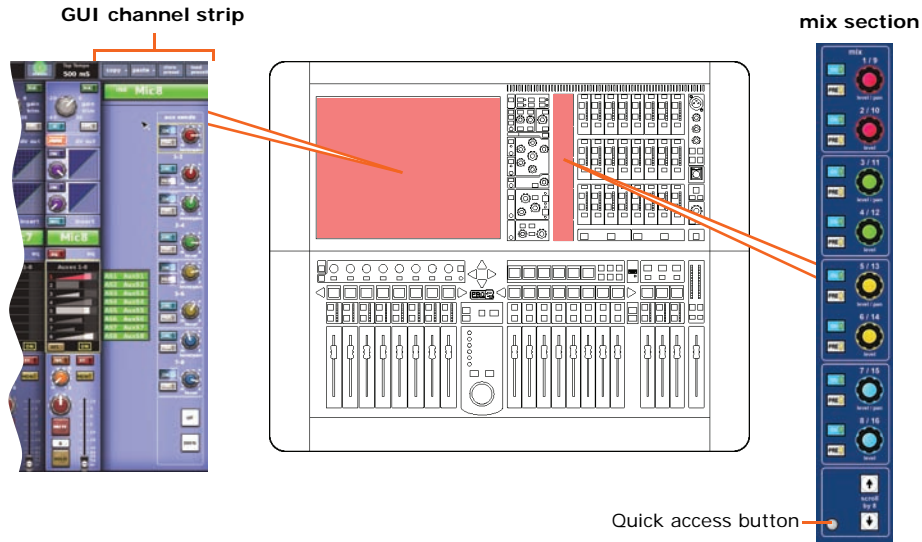

Figure 6: Mix section

On the GUI, the bank of mix buses in each input fast strip (see Figure 7 below) are colour matched, but also show mix bus status information.

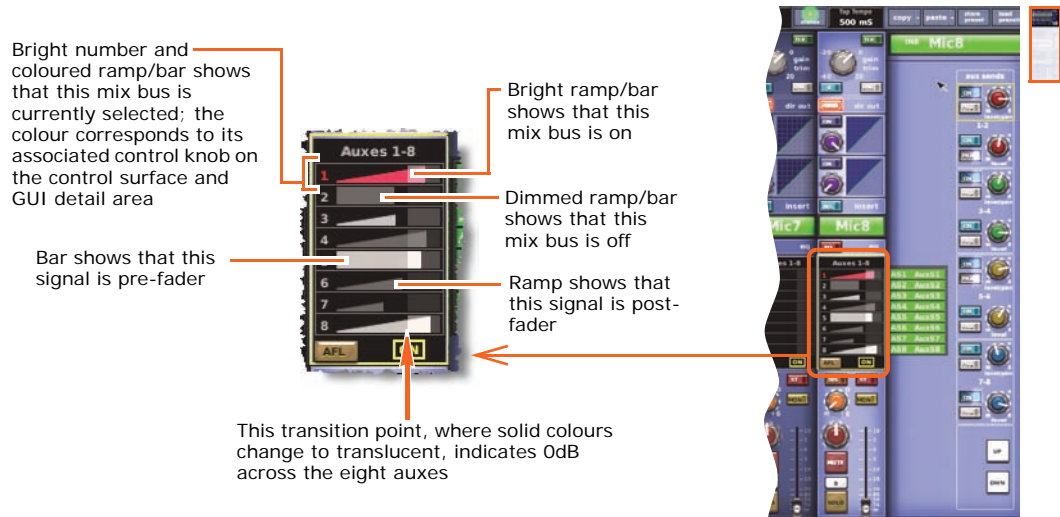

Figure 7: Typical mix section in a GUI input fast strip



## &gt;&gt; To select the mix bus mode

- 1 In the mix bay, select the desired aux channel.
- 2 In the channel strip, press the quick access button to select the aux's configuration detail area.
- 3 In the GUI channel strip, click **MODE** repeatedly to cycle through the mix modes (**mix**, **group** and **mix minus**) to choose the one you want. The currently selected mix mode is shown to the right of the **MODE** button.

**group** mode is fader only with no pre-fader. In **mix minus** mode all buses are initially routed — you have to switch a bus routing switch on to take it out of the mix. For information about stereo **mix** mode, see "Linking two mixes" on page 78.



## &gt;&gt; To set up a mono aux mix

- 1 Making sure that the mix bus is not linked (to ensure mix is mono), select the bus mode as **mix** (see "To select the mix bus mode" above).
- 2 Select the input channel.
- 3 In the appropriate **mix** section, do the following to your chosen mix (for example, aux 3 or 11 shown right):
  - Press **PRE** to select pre-fader (on) or post-fader (off).
  - Press **ON** to route the aux mix from input to aux output.
  - Adjust the level control knob to change the signal level to suit.

**Mix bus routing**

You can route an aux or matrix (or even master output) to an effect or output. This is a GUI-only operation, which is done via the GUI channel strip or **Patching** screen (see Chapter 8 "Patching" on page 47).

## &gt;&gt; To route an aux or matrix to an effect or output

Do one of the following:

- In the GUI channel strip, select the required mix bus destination from the drop-down list.
- In the GUI channel strip, click **dest** (shown right). This will open the **Patching** screen and the appropriate tab.
- In the **Patching** screen, route the aux/matrix. For information on patching, see Chapter 8 "Patching" on page 47.



## Linking two mixes

You can link two mixes together, which is a GUI only feature. Pairs can only be created from adjacent mix buses of the same colour, for example, you can link auxes 3 and 4 together, but not 2 and 3.

### >> To route an aux or matrix to an effect or output

To link a pair of mix buses, click the **LINK** button in the channel strip of either mix bus. For example, click **LINK** of aux 15 to link it to aux 16 (shown right).



### Setting the linked parameter options

The shared parameters default to the user-configurable global default link settings, which are set via the GUI menu (choose **home** ▶ **Preferences** ▶ **General** and click the **Linking** tab). However, you can override these for the pair via the **Stereo Linking Options** window (shown right), which is opened by clicking the **st. linking options** button (GUI channel strip).

In stereo mix mode the top control knob becomes pan adjust and the bottom one adjusts level. When creating a stereo mix, you can use either the odd or even output to link the two channels, but the mode of the odd channel is used on both.

For details of the parameters that are stereo linked, see Appendix J "Parameters Affected By Stereo Linking" on page 461.





## Setting up the effects rack

You can set up the effects rack (in the GUI menu's **Effects** screen) to contain any of the eight available effects listed in the **Change Device Type** window, in any of the 16 rack positions. The diagram right shows the rack populated with all available effects.

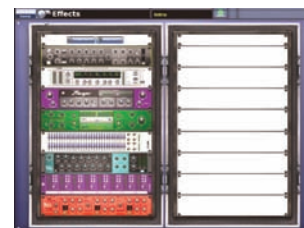

The **assignable controls** (shown in the **Delay** diagram) are common to all effects, and let you control effects parameters via the I zone (output bay's control surface).

**Stereo delay** — provides simple delay line-based effects. Delay times can be specified manually or you can use the 'tempo-tap' button.



**DN780 (stereo reverb)** — is a reverberation device that emulates the Klark Teknik DN780 Digital Reverberator/Processor unit and allows you to create unique acoustic environments of virtually any type.



**Stereo flanger** — has one or, if configured as stereo, two tap delay lines. One tap is fixed and the other tap position is modulated to provide 'thru-zero' flanging or single tap modulation when 'thru-zero' is off.



**Stereo phaser** — has one, or if configured for dual operation, two stereo phasers connected in serial or parallel, according to mode setting.



**Pitch Shifter (harmoniser)** — has two independent channels that can independently shift the pitch of signals up/down to correct poor pitching or generate harmonies. The pitch change can also be modulated as an effect.



**8-channel SQ1 Dynamics** — is an emulation of the Klark Teknik Square ONE Dynamics, which is an 8-channel analogue dynamics processor. Used for the precise manipulation of compression parameters, it also includes gating for creative and corrective applications, and channel linking for stereo/multi-channel operation.



**3 Band Compressor (stereo multi-band compressor)** — is a minimum phase shift (analogue style) implementation that guarantees coherent band summing, even at the most extreme crossover point settings. Each band provides full control of its compressor's action, with partially adaptive time constants ensuring the most natural results from even the most variable sources.



**Dynamic Equaliser** — is a 4-band parametric dynamic equaliser, which is able to provide frequency selective compression or expansion.



>> To add an effect to the effects rack

1 At the GUI screen, choose **home ▶ Rack Units ▶ Effects**. Alternatively, press the **effects / graphics** screen access button in the navigation zone.

2 Choose the rack position and click within it.

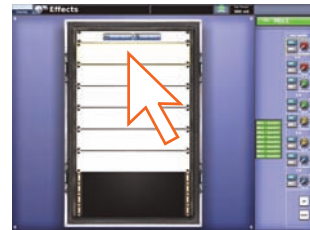

3 In the effect's window, click **Change Device Type**.



4 In the **Change Device Type** window, select the device type. For example, "Phaser".

5 Click **OK**.

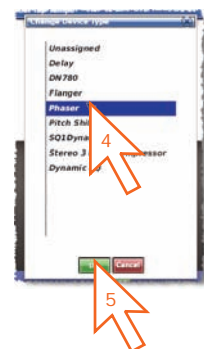

- 6 Change the parameters of the new effect device as necessary. For example, adjust control knobs, press buttons etc. You can even change the effect's name by editing its name field (upper-left corner of effect). You can do this via the GUI or from the I zone using the output bay GUI (see "PRO2 control surface" on page 18).
- 7 Click **OK** to exit. The new effect will appear in the effects rack.

You can now patch the new effect, which will be on the **Effects** tabs of both the **From** and **To** sections of the **Patching** screen. For information on how to patch, see Chapter 5 "Patching" on page 23.



## Simple routing to master stereo outputs

The following shows you how to obtain audio.

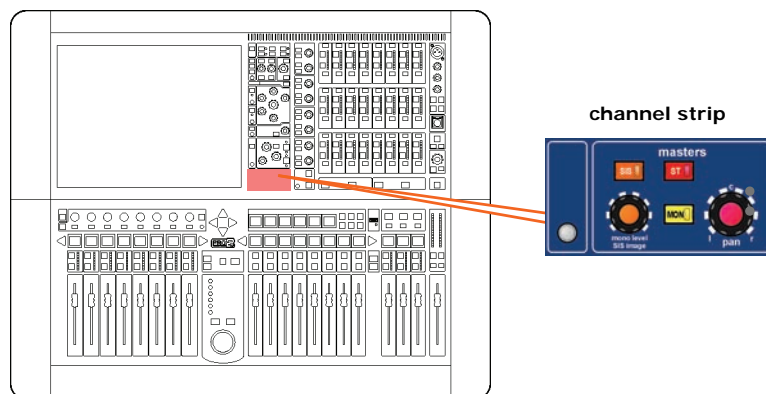

### >> To obtain audio

- 1 Make sure nothing is muted and the master faders are up.
- 2 In the **masters** section of the channel strip, press **ST** (stereo). You should have audio.

## Automation

PRO2 automation is managed from the **Automation** screen of the GUI menu, with support from the **automation** section of the control surface (output bay).

The **Automation** screen (a typical example is shown right) has the following functions and features:

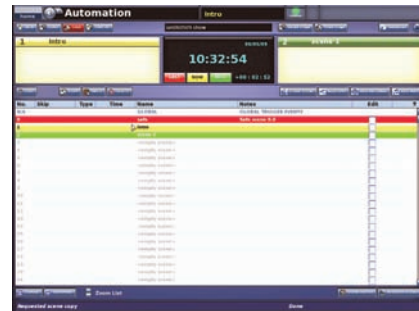

- **Show management** — see “Managing the shows” on page 82.
- **Scene management** — see “Managing the scenes” on page 84.
- **Event management** — see “Additional control — managing events” on page 85.
- **Cue list** — shows the scenes and point scenes in performance order. The cue list includes information such as scene number, name, notes etc. You can expand and unexpand the point scenes and ‘zoom’ the list on/out. It also lets you reorder the scenes.
- **Scope** — the **Recall Scope** and **Store Scope** buttons open the scope screens, from which you can select the automated controls that you want to leave in/out of a scene when it is stored or recalled.
- **Rehearsal** — the **Rehearsal** button lets you carry out a rehearsal, which will ‘skip’ (leave out) any scenes that you choose.

**Note: Note:** With no show loaded, the **Automation** screen will be blank.

### >> To open the Automation screen

Do one of the following:

- At the GUI, choose **home ▶ Automation ▶ Automation**.
- In the navigation zone, press the **automation / filing** screen access button.

## Managing the shows

The four buttons (**NEW**, **LOAD**, **SAVE** and **SAVE AS**) towards the top of **Automation** screen let you create a new show, load an existing show, update the current show or create a new show using the current settings.

### Important:

We recommend that you save your show settings regularly (see “Saving a show versus storing a scene” on page 36). The PRO2 will indicate that there are show settings to be saved by changing the background colour of the **SAVE** button to red (shown right).

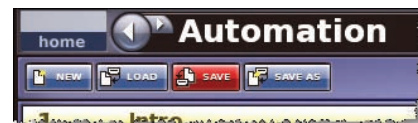

The eye icon  in the **Automation** screen (just under the **ADD MIDI** button) opens the **Show** window. This window contains a number of filter options, such as empty scenes, MIDI events etc., that you can choose to exclude from your show.

### >> To create a new show

- 1 Click **NEW**.

- 2 At the **Enter new show name:** message window, type your chosen name for the new show.
- 3 Click **OK**. You can now create and manage the scenes for your new show.



### >> To save a show or create a new one from the current settings

Do one of the following:

- To update the current show with the latest settings, click **SAVE**.
- To create a new show using the current show settings, click **SAVE AS**. Then, in the **Save File** window (shown right), type in the name of the new show in the **Save this file as:** name field. Click **OK** to save the new show and close the window.
- To overwrite an existing show, click **SAVE AS**. Then, in the **Save File** window (shown right), click the show you want to overwrite to select it, click the **Overwrite existing?** box to select it this option and then click **OK**.



### >> To load a show

- 1 Click **LOAD**.
- 2 In the **Load File** window, click the show file you want to load (shown right). For example, "Replica.show". The file name will appear in the **Load this file:** name field.

The **Load File** window will contain a list of all the shows currently loaded. If the one you want is not there, import it (see "To load (import) a show file from a USB memory stick" on page 92).

- 3 Click **OK**. The file will start loading and the window will close.

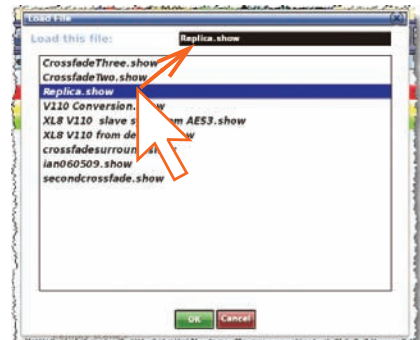

When the file has finished loading, its name will appear in the show file name field (to the right of the **SAVE AS** button).



## Managing the scenes

Up to three scenes in the cue list will be highlighted to indicate your position in the show, as follows:

- **LAST** (red) — the scene immediately before the most recently loaded one.
- **NOW** (yellow) — the most recently loaded scene.
- **NEXT** (green) — the next available 'non-empty' scene.

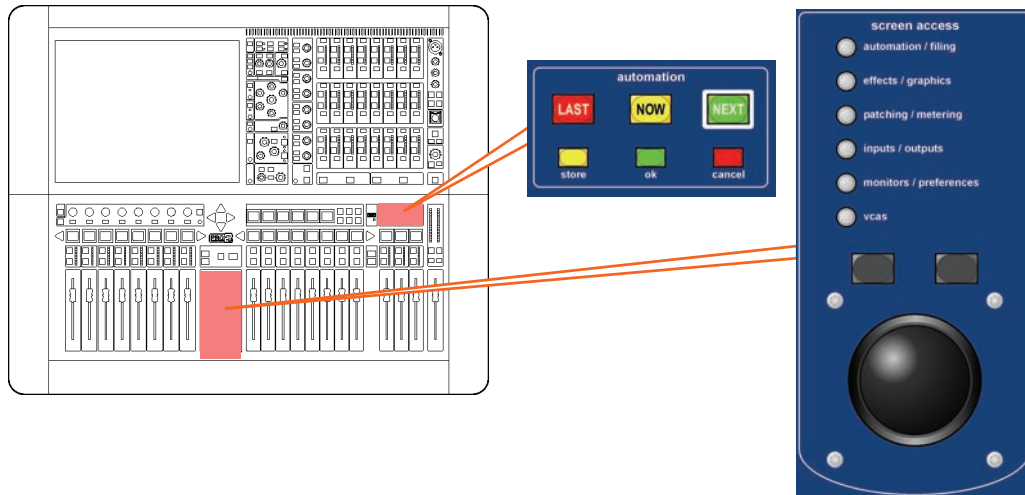

The **automation** section in the output bay (see “PRO2 control surface” on page 18) supports the **Automation** screen by providing controls for scene navigation, selection and management. The jogwheel is a unique automation controls, whereas the other buttons are replicated on the GUI.

### >> To recall a scene

#### Important:

When recalling a new scene, make sure monitor output levels are low, as the new scene's settings may produce higher audio output levels than the one it is replacing. Also, recalling a scene clears any unsaved adjustments made to the previous scene.

Press **last**, **now** or **next** as desired.

### >> To create a new scene using the current settings

- 1 Do one of the following:
  - In the automation section, press **store**.
  - In **Automation** screen on the GUI, click **STORE SCENE**.
- 2 In the **Store Scene** window, type in the scene name if necessary.
- 3 In the **Notes** panel, type in any scene notes as desired.
- 4 Do one of the following:
  - Click “Insert before scene” to put the new scene in between the one currently highlighted in yellow and the scene immediately before it.



- Click “Store to empty scene” to put the new scene in the one currently highlighted in yellow, provided it is empty.
- Click “Store to next scene” to put the new scene in the next one, provided it is empty.
- Click “Overwrite scene” to overwrite the scene currently highlighted in yellow.

The options are context-sensitive, so some may be greyed-out to show that they are unavailable. An **OK** button will appear at the bottom of the window when a valid store scene option has been selected.

- 5 Click **OK**.







### Additional control — managing events

You can use the MIDI or GPIO functions of the PRO2 to control the parameters of an external device (outgoing), and conversely you can use an external device to control the PRO2 (incoming). Also, by using the PRO2’s unique ‘internal’ event option, you can trigger events from within the showfile itself. All this is done by creating events in scenes/point scenes.

You can have any number and types of events in any scene/point scene; their parameters are set up and edited in an **Edit Event** window. Similarly to scenes/point scenes, you can skip events during rehearsals.

Events (and scenes/point scenes) have a right-click menu (shown right) that lets you to create, edit and copy events.

The following shows what some of the event symbols in the

**Automation** screen mean:  = currently selected event;  = MIDI event;  = GPIO event;  = internal event;  = incoming event; and  = outgoing event.

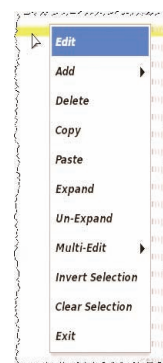

#### >> To create an event

Select the scene in which you want to create the event, and then do one of the following:

- Click the **ADD GPIO**, **ADD INTERNAL** or **ADD MIDI** button as necessary.
- From the right-click menu, choose **Add ▶ Midi Event**, **Add ▶ Internal Event** or **Add ▶ GPIO Event** as necessary.

#### >> To edit an event

- 1 Open the **Edit Event** window by doing one of the following:
  - Right-click the event you want to edit and then choose **Edit**.
  - Select the event you want to edit and then click **EDIT**.
- 2 In the **Edit Event** window, choose your options as necessary. For example, you can use a program change to trigger the event.
- 3 At the upper-right corner of the **Edit Event** window, click “X” to close it.

Changes in the **Edit Event** window are *live*, that is, they are immediately reflected in the show file. So you don’t have to save the scene, as these are not audio parameters.

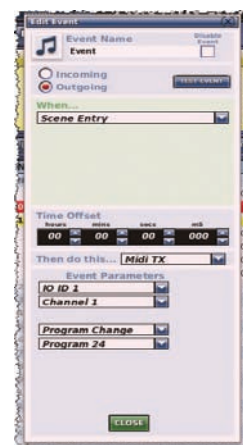

## Show editor

The show editor is a GUI-only function that allows you to very easily copy and paste settings through scenes. This is done via the **Show Editor** screen.

The **Scenelist** on the right of the screen is a cue list of the current show. Source lists (channels, GEQs, effects and groups) are to the left of the screen, from which you can copy the settings, and in the middle (**Sections**) are the areas you can copy.

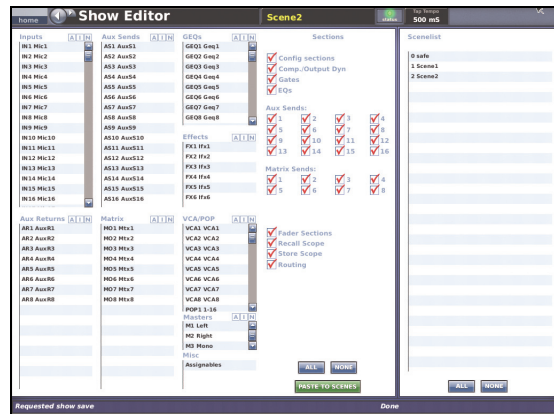

>> To open the Show Editor screen

Do one of the following:

- From the GUI menu, choose **home** ▶ **Automation** ▶ **Show Editor**.
- At the **Automation** screen, click **SHOW EDITOR**.

>> To copy and paste sections to a scene(s)

- 1 In the **Show Editor** screen, choose from the sources (far left) that contain the settings you want to copy from the lists. You can choose any combination.
- 2 Under the **Sections** heading, choose the sections that you want to copy. Ticked options will be copied. You can use the buttons underneath to help you, as follows:
  - Click **ALL** to select all of the sections.
  - Click **NONE** to deselect all selected sections.
- 3 In the **Scenelist**, click the scene(s) in which you want to paste the settings. You can use the buttons underneath the list to help you, as follows:
  - Click **ALL** to select all of the scenes in the list.
  - Click **NONE** to deselect all selected scenes.
- 4 Click **PASTE TO SCENES**.

## Configuring the inputs and outputs

Similarly to the VCA/POPulation groups, you can change the name and colour of each of the inputs and outputs. This is done via the GUI at the **Naming Sheet** screen. For configuration details, see “Using VCA/POPulation groups” on page 74.

>> To open the Naming Sheet screen

Do one of the following:

- At the GUI, choose **home** ▶ **Input Channels** ▶ **Naming Sheet**. Alternatively, choose **home** ▶ **Mix & Outputs** ▶ **Naming Sheet**.
- In the navigation zone, press the **inputs/outputs** screen access button once to open the **Input Sheet** screen or twice to open the **Output Sheet** screen.



## Using copy and paste

The **copy** and **paste** buttons (upper-right corner of GUI) let you copy the parameters of a channel's detail area (EQ, compressor, gate etc.) or all of its details areas, and paste them to another channel/all channels of a similar type. Both buttons have a right-click menu.



### >> To copy a detail area to a channel/all channels

- 1 Navigate the detail area to its local channel strip.
- 2 Click **copy**.
- 3 Do one of the following:
  - To copy the detail area to another channel, select the channel and then click **paste**. As the copied parameters are still stored, you can paste to as many channels as you want.
  - To copy the detail area to all other channels, right-click **paste** to open its menu and then choose **Paste To All**.



### >> To copy all parameters to a channel/all channels

- 1 Select the channel from which you want to copy all parameters.
- 2 Right-click **copy** and then choose **Copy All**.
- 3 Do one of the following:
  - To copy all the parameters to another channel, select the channel and then click **paste**.
  - To copy all the parameters to all other channels, right-click **paste** and then choose **Paste To All**.



## Copy and paste rules and restrictions

- You can only copy and paste similar functions. For example, you can't copy the input EQ from one channel to the output EQ of another, as they are different.
- You can only copy and paste across similar channel types. For example, you can't copy from an aux and paste to a matrix.
- Copying and pasting across inputs is restricted to the input bays only.
- Channel names are not copied.
- Compressor and gate side chain listen cannot be copied.

For details of the channel parameters that are copied across, see Appendix I "Parameters Affected By Copy And Paste" on page 431.

## User library (presets)

The PRO2 has a user library where you can store settings, such as for the EQ or even the whole channel. For example, you may wish to store the EQ settings of a singer who may be called upon to perform during a future show. You can then easily recall these EQ settings to the appropriate channel when required.



The settings are stored as presets, which are saved in a library. The library files are managed via a **Preset Manager** screen in the GUI menu. This screen has **New**, **Load**, **SAVE** and **Save As** function buttons that let you create new libraries, load existing libraries, save the current library or give it a new name. You can also delete presets from the library.

**Before you can save/load a preset, you need to create a new preset library or open an existing one.**

### >> To create a new preset library

- 1 From the GUI menu, choose **home ▶ Preset Manager**.
- 2 In the **Preset Manager** screen, click **New**.
- 3 In the **Enter new Library name window**, type in your chosen name for the new preset library.
- 4 Click **OK**.



### >> To save a preset to the user library

- 1 Navigate your chosen settings to the channel strip.
- 2 At the GUI, click **store preset**.
- 3 In the **Save Preset** window, do the following:
  - In the **Preset Name** field, choose the preset.
  - In the **Preset Author** field, type in your name.
  - In the **Notes** field, type in any notes to help you identify the contents of the preset.
- 4 Click **OK**.

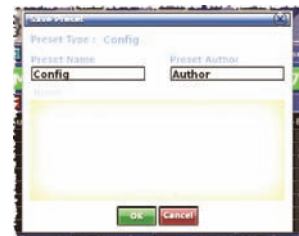

If a message window opens containing the text "There is already an existing preset of that name. Do you wish to overwrite?", click **OK** to overwrite the existing preset. Otherwise, create a new one by clicking **Cancel**, choosing another preset name and then clicking **OK**.

### >> To load a preset

- 1 Select the channel in which you want to load the preset.
- 2 At the GUI, click **load preset**.
- 3 In the **Load Preset** window, choose the preset you want to load.
- 4 Click **OK**.



## Surround panning

In addition to stereo and left-centre-right (LCR) panning, PRO2 has three surround panning modes: quad; left, centre, right and surround (LCRS); and 5.1 surround. To help you visualise the surround panning envelope, the masters detail area of the GUI channel strip has a spatial diagram (shown right) that updates when you operate the panning controls.

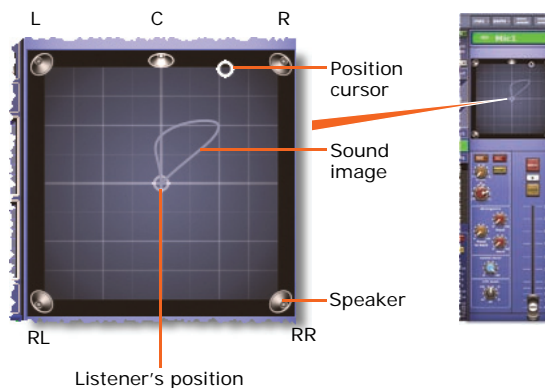

The 5.1 panning mode uses six matrix channels, while quad mode uses four (left and right on both the front and surround). Although the LCRS mode uses five channels (front left and right, centre and surround left and right), both surround channels are the same. (In an LCRS surround panning arrangement, you can have a single surround speaker positioned directly behind the listener.)

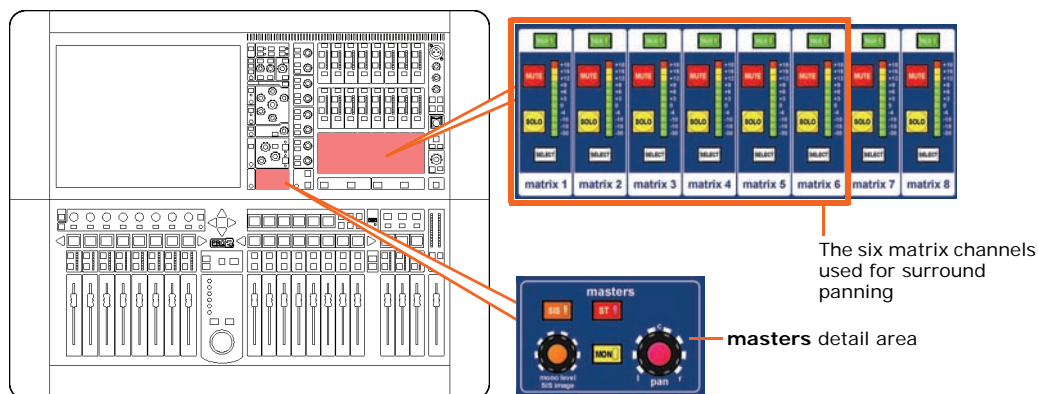

The sound image is controlled via the **masters** detail area. The following below shows the recommended<sup>1</sup> 5.1 surround system configuration.

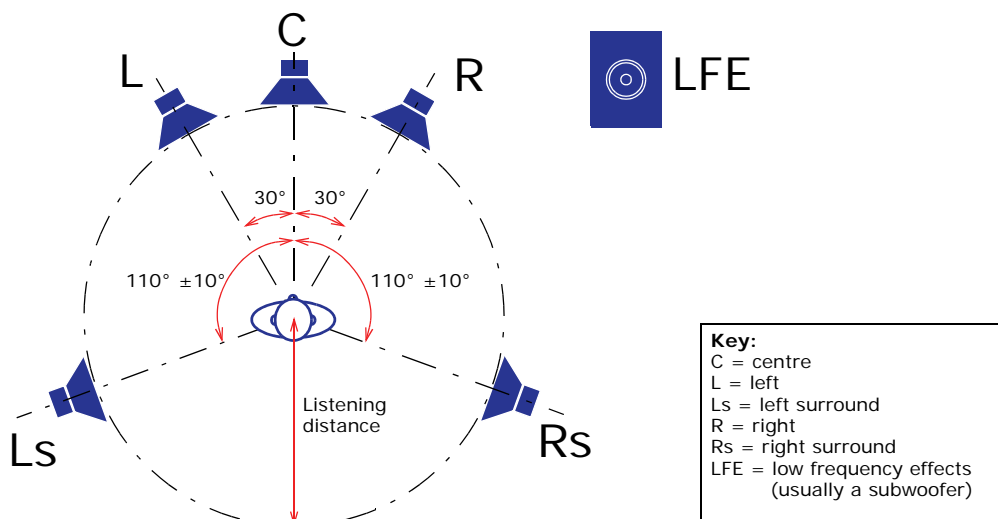

Figure 8: 5.1 surround panning loudspeaker arrangement

1. Reference - ITU-R BS.775.1, 1994. *Multichannel stereophonic sound system with and without accompanying picture*. International Telecommunications Union.

In surround mode, the **SIS** button routes the channel to the surround buses in much the same way that the **ST** button routes to the master buses. Surround panning mode is selected via the **Surround Mode** options of the **Preferences** screen (choose **home** ▶ **Preferences** ▶ **General**).

## Area B operation

You can configure the PRO2 Control Centre to have an area B, where any three channels of your choice populate the master channel strips and are totally independent of the ones assigned to the channel/mix faders. This mode of operation is enabled on selecting a VCA/POPulation group that is configured for area B operation. The three master channels then operate as area B, which is populated by the first three channels in the group.



*This feature can also be used by a single operator if they require somewhere to store important channels. In this case, area B can be used in the same way a 'channel 25' would be used on an analogue console.*

During area B operation the mix bay is common to both areas. Also, you can have the same channel selected simultaneously in both areas (A and B). You can select a VCA/POPulation group in area A provided it is not configured for area B operation. However, pressing the LCD select button of another VCA/POPulation group that has been configured for area B operation will have no effect.

**Note:** When operating in area B, remember to select the B option as necessary, particularly in the monitor section. Also note that solo B (also for talkback) is totally independent of area B, which is used for navigation only.

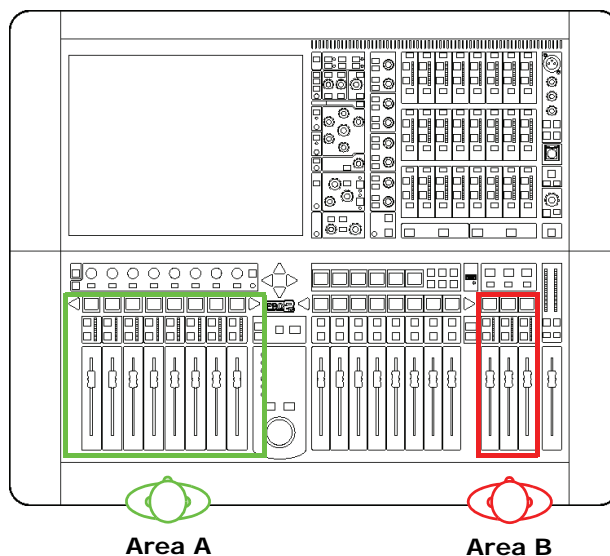

*A and B areas on the control surface*

### >> To enable Area B operation

Provided the desired VCA/POPulation group has been configured for area B operation (see "VCA and POPulation groups" on page 143), simply select the group by pressing its LCD select button. The master channels will be populated with the group's area B channels.

## Saving your show files to a USB memory stick

When you are satisfied that your show file is how you want it, we recommend that you save it to a removable storage device (USB memory stick). This provides a valuable back up should the show file stored in the internal memory of the PRO2 be lost, for example, due to inadvertent deletion. You can also load show files onto the PRO2 from the same storage device.

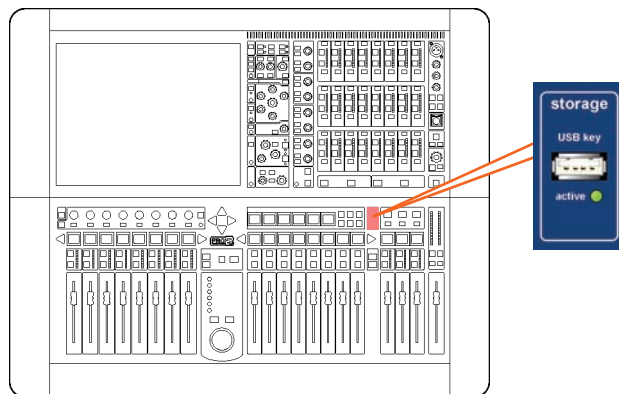

### >> To save (export) a show file to a USB memory stick

- 1 If necessary close and save the show file you want to export. You can't export a show file that is open.
- 2 Insert the USB memory stick into the **USB key** socket (shown above).
- 3 Do one of the following:
  - At the GUI, choose **home ▶ Files**.
  - In the navigation zone, press the **automation / filing** screen access button twice.

- 4 You may see an "Analysing..." message in the **Removable Storage** panel, which means that the Midas folder on the USB memory stick is being read. Wait for the message to clear. Then, in the **Control Surface** panel, click the show file you want to copy (shown right).

Both lists show user libraries (presets) as well as show files. If there are neither of these file types on the USB memory stick, the **Removable Storage** panel will be empty.

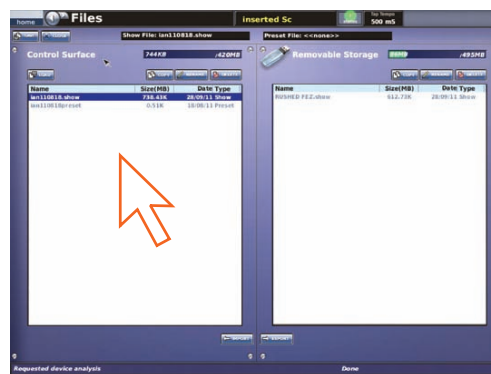

- 5 Click **EXPORT**.
- 6 In the **Are You Sure you Want To Export?** message window, click **OK** (shown right). The file will start copying to the USB memory stick.
- 7 When your show file appears in the **Removable Storage** panel, it has finished copying to the USB memory stick. Remove the USB memory stick.

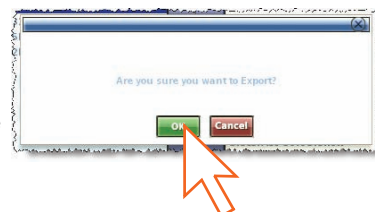

### >> To load (import) a show file from a USB memory stick

The procedure is similar to the export procedure, as detailed in “To save (export) a show file to a USB memory stick” above, but select the file to be imported to the PRO2 from the **Removable Storage** panel and then click **IMPORT**.

## External AES50 synchronisation

If you want to connect AES50 audio between two Midas digital consoles the slave console must be set to external AES50 synchronisation, irrespective of the synchronisation source of the master console.

<i>Console 1 sync setting</i>	<i>Console 2 sync setting</i>			<i>External AES50 from console 1</i>
	<i>Master</i>	<i>Word clock</i>	<i>AES3</i>	
<b>Master</b>	Not valid	Not valid	Not valid	Valid connection
<b>Word clock</b>	Not valid	Not valid	Not valid	Valid connection
<b>AES3</b>	Not valid	Not valid	Not valid	Valid connection
<b>External AES50 from console 2</b>	Valid connection	Valid connection	Valid connection	Not valid

A valid connection can be a tie line between the stage routers or the secondary port (Bx/By) of a mic splitter that has its primary port (Ax/Ay) connected to the master console.

Make sure that the DL431 Mic Splitter is set to synchronise from the master console.

## Security (locking mode)

To preserve the current state of the PRO2 Control Centre and to prevent unauthorised adjustment of its settings, you can lock it; this is a GUI-only function. When locked, none of the controls on the control surface will function and the PRO2 Control Centre will be totally locked out.

At a GUI screen, choose **home ▶ Lock**.

### >> To unlock the PRO2 control centre

At a GUI screen, click the **UNLOCK** button (lower-left corner of screen). The PRO2 Control Centre will revert to the state it was in when it was previously locked.

# *Advanced Operation And Features*





## Chapter 10: Stereo Linking

This chapter describes stereo linking, or *channel pairing*, which lets you configure two adjacent channels as stereo. The diagram right gives an example of two linked channels (auxes 15 and 16).

By default, all channels of the PRO2 are unpaired (mono). When paired, the controls for each signal path act simultaneously on both the left and right signal paths. Individual trims, for example, adjusting the mic amp gains to balance stereo mix inputs, can be applied to the left and right audio paths individually. The channels are not truly mono at this time and any settings necessary to preserve the audio prior to trimming, such as dynamics side chain linking, are maintained.

When linking previously unlinked channels, some normalisation of the prospective left and right control settings — which may be quite different — is required. The PRO2 does this by automatically copying the control settings of the left (odd-numbered) channel, with the exception of the pan controls, to the right channel. The pan controls, depending on whether they are in the left or right audio paths, should be manually set to hard left or hard right, respectively.



Linking is a GUI-only function, as there are no link buttons on the control surface. You can link any two adjacent input channels together. However, although each output channel has a link button only the ones on the odd numbered channels function (for example, you can link aux send channel 7 with aux send channel 8, but you cannot link aux send channel 8 with aux send channel 9).

### >> To link two channels

- 1 If necessary navigate the desired channels to the channel faders.
- 2 In the GUI fast strip of the desired channel, click **LNK**. Alternatively, you can click the **LNK** button in the GUI channel strip if the desired channel and its appropriate detail area is selected.
- 3 In the channels you have just linked, set the **pan** control knob in the left channel fully anti-clockwise and the one in the right channel fully clockwise.

## Changing the linking options

You can choose which control options will be linked across the channel pair. There are two ways to do this: globally and per pair. The per pair settings always override the global ones. For details of the linked parameters for each section, see Appendix J "Parameters Affected By Stereo Linking" on page 461.

### >> To set the global default stereo linking options

- 1 At the GUI, choose **home ▶ Preferences ▶ General** and then click the **Linking** tab to open the **Preferences Link** screen (shown right).
- 2 In a channel section, select the desired default stereo linking options and then click the **Change Existing** button at the bottom of the section.



**Note:** *Deselecting a linking option (unticking its box) automatically updates the status of unlinked channels of a similar type accordingly. However, clicking **Change Existing** updates the status of all unlinked and linked channels of a similar type.*

Repeat for the other channels that you want to change the default stereo linking options of.

Selected control options will be linked across the channel pair of the appropriate type. Unselected controls remain independent on each channel.

### >> To set the stereo linking options for a channel pair

- 1 Make sure that one of the paired channels is selected and its configuration detail area is assigned to the GUI channel strip, and then click the **st. linking options** button in the GUI channel strip.
- 2 In the **Stereo Linking Options** window, select the controls that you want to be linked across the channel pair.
- 3 Click **CLOSE**.

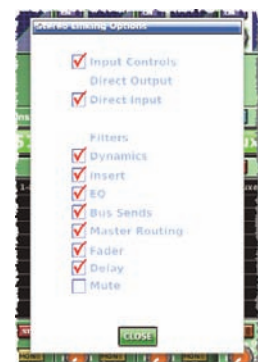

## Chapter 11: Panning

The PRO2 has two main types of panning mode, default and surround. The default mode comprises stereo and LCR panning formats, and only uses the channels for the front loudspeakers, while the surround mode includes channels for the rear surround loudspeakers. For more information, see “Surround panning” on page 89.

The following table shows the panning formats available on the PRO2.

**Table 3: Panning formats**

<i>Panning mode</i>	<i>No. of channels</i>	<i>Format</i>	<i>Channel types</i>
Default	2	Stereo	L, R
	3	LCR (SIS™)	L, C, R
Surround	4	Quad	L, R, Lr, Rr
	5	LCRS	L, C, R, Ls, Rs
	6	5.1	L, C, R, Ls, Rs, LFE

**Key:** L = left; R = right; C = centre; Lr = left rear; Rr = right rear; Ls = left surround; Rs = right surround; LFE = low frequency effects (usually handled by a subwoofer)

### >> To select the panning mode

At the GUI, choose

**home** ▶ **Preferences** ▶ **General**.

Then click the **Show** tab to open the **Preferences Show** screen. Click the desired panning mode in the **Surround Mode** section.

**Note:** The **None** option is the default mode for stereo and LCR (SIS™) (see Table 3 above).

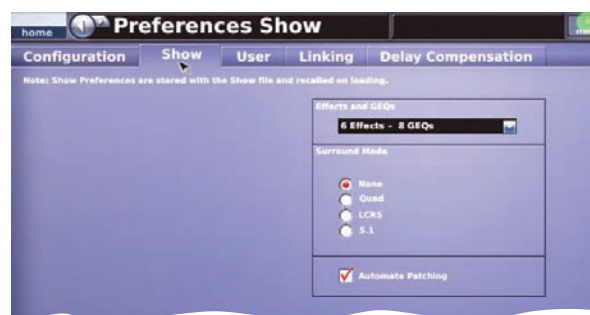

## Stereo panning

The control surface controls for stereo panning are located in the **masters** section of the channel detail area. The **pan** control in each **masters** section may be switched for either conventional or spatial imaging system (SIS™) stereo operation via the **ST** or **SIS** switches, respectively.

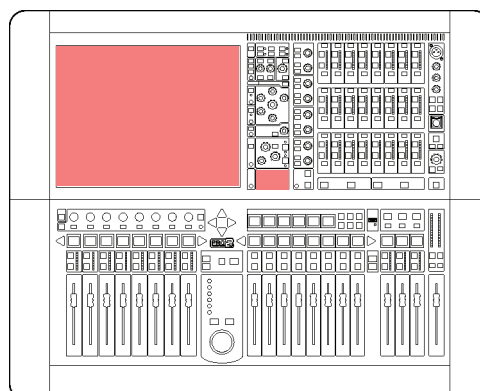

## SIS™ (LCR) mode

The MIDAS SIS™, which is used for left-centre-right (LCR) loudspeaker systems, configures the channel for LCR mixing. The **SIS** switch activates the spatial imaging system, which uses the **SIS image** control knob to modify **pan** control knob operation so as to place the channel within a three-speaker system.

With **SIS image** control knob set fully clockwise or anti-clockwise, image is full LCR or stereo, respectively. Control knob positions in between generate a composite blend of stereo or LCR panning systems, so that optimum degrees of centre image focus and speaker power can be obtained.

Constant power is maintained at all times so that the *image* can be adjusted during the show without a perceived change in level.

### SIS image control knob fully clockwise (LCR)

With the **SIS image** control knob fully clockwise, the **pan** control knob operates in full LCR mode. A centre-panned signal, that is, with the **pan** control knob set to the **c** position, routes to the centre speaker only; there is no signal in the left and right speakers.

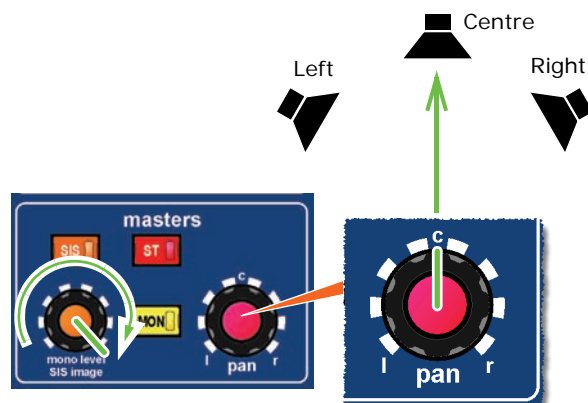

**SIS image control knob fully anti-clockwise (stereo)**

With the **SIS image** control knob fully anti-clockwise, the **pan** control knob operates as stereo. A centre-panned signal routes to the left and right speakers at equal power.

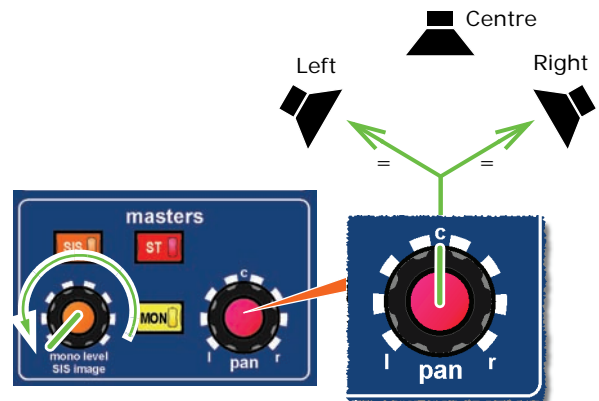
**SIS image control knob centred (equal power)**

With both the **SIS image** and **pan** control knobs centred, the signal is routed to all three speakers with equal power.

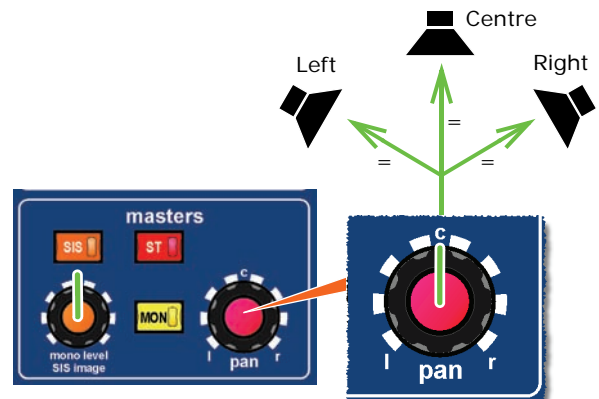

## Surround panning

When the PRO2 is configured to operate in one of the surround panning modes, the spatial diagram that appears in the GUI channel strip gives you a visual representation of the sound image in relation to the speakers.

The following diagram shows the appearance of the GUI channel strip for each panning mode, and describes the controls.

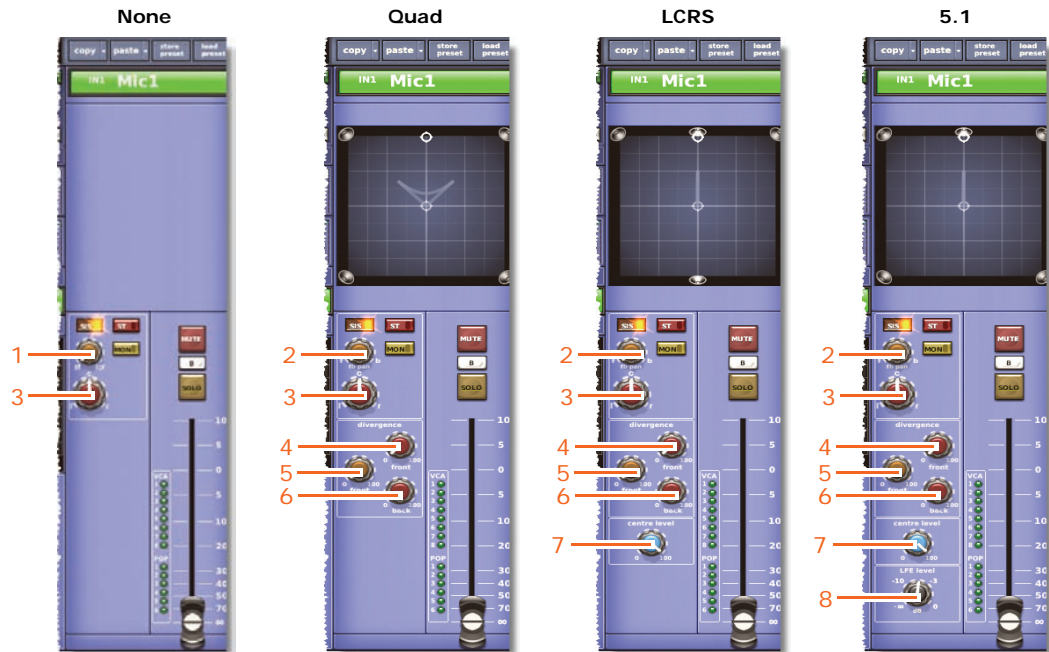

Item	Description	Function
1	SIS™ image control knob	With <b>SIS</b> switched on, this adjusts the SIS™ image. With <b>SIS</b> switched off, this adjusts the mono level.
2	<b>fb pan</b> control knob	Moves the position cursor in the spatial diagram up/down. With <b>SIS</b> switched off, this adjusts the mono level.
3	Left-centre-right (LCR) control knob	Moves the position cursor in spatial diagram left/right.
4	<b>front</b> control knob	Adjusts the divergence of the front speakers.
5	<b>front to back</b> control knob	Adjusts the divergence of the front and rear speakers.
6	<b>back</b> control knob	Adjusts the divergence of the rear speakers.
7	<b>centre level</b> control knob	Adjusts the divergence of the centre speaker.
8	<b>LFE level</b> control knob	Adjusts the signal level of the LFE (usually a subwoofer).



*Although the position cursor changes automatically according to the adjustment of the surround panning controls, you can also adjust it on the GUI using drag.*

## Speaker placement

As the placement of loudspeakers is very important for accurate mix monitoring — especially for multi-channel mixing for surround sound — you should consider speaker positioning, angling and level calibration when setting up your monitor system. If necessary consult the manufacturer of your monitor system for their recommended surround formats.

The following diagram — which is to be read with Table 3 “Panning formats” on page 97 — gives you examples of loudspeaker placements for each panning mode. However, they are only an approximation and should only be used as a guide.

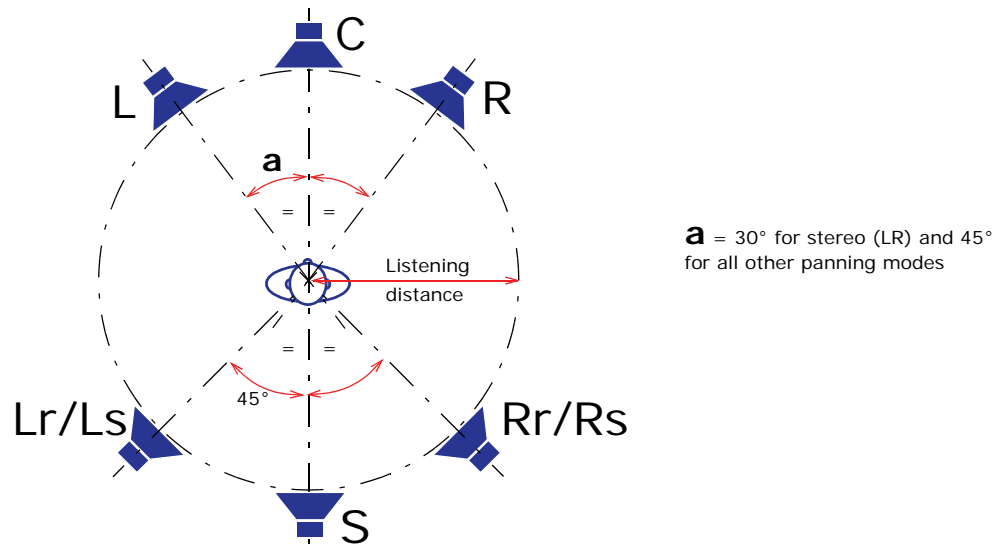

**Note:** LCRS has a mono surround channel, which is often fed to two rear ‘satellite’ speakers.





## Chapter 12: Soloing

Solo enables a signal to be monitored at a level proportional to its level in the mix, in the same stereo position in the mix and with the same signal processing as in the mix. When a solo button is pressed, all signals routed to the monitor output — except the one selected by the solo button — will be cut. Solo allows a sound in one channel to be isolated, which is helpful in fault finding and when equalising a signal.

There are two independent solo systems in the console, solo A and solo B. Both have monitor outputs and solo A has a headphone output, and both can be used to PFL or AFL signals from the same sources throughout the console. This flexible solo bus configuration makes soloing of three-way monitor mixes (in-ears going to solo A and wedge going to solo B) possible.

### Solo A

With solo A on, solo goes to the selected solo bus with the following conditions:

- If solo button is pressed for a short time, the soloing to the selected solo bus remains active when the button is released. If press is sustained (solo button held down) the soloing to the selected solo bus is cancelled when the button is released.
- Pre-fader audio is sent to the selected solo bus if the associated PFL control for that bus is active. Post-fader audio is sent to the selected solo bus if the associated PFL control is inactive.
- Unless multiple solo activations to the same solo bus are concurrent, the solo activation that occurred last - while the respective solo add mode (A or B) is inactive - cancels all earlier solos to the same bus before it activates.
- Solos can also be operated from a VCA master when the channel to which they belong is a member of that VCA; this is in addition to the local operation.
- Pressing the solo **CLEAR** button associated with the solo bus they are sending to (A or B) will clear active solos.
- A two-level solo hierarchy exists for each of the solo buses in the console (see “Solo hierarchy” on page 105); the levels are inputs and returns, and aux sends and matrices and masters. Activating a solo with a higher precedence in the hierarchy deactivates all solos with less precedence and inhibits them from being operated. As soon as the higher precedence solos are cleared, the stages of the inhibited solos are restored and they resume normal operation.
  - With any inputs active, outputs can't be soloed.
  - with any outputs active, pressing an input solo overrides (cancels) output. When the input solo(s) is cancelled, the output solo(s) are returned.
- Pressing ADD (solo a/b) off cancels all solos and then allows you to solo multiple channels simultaneously.
- Pressing PFL (solo a/b) on changes the point at which the soloed signal is taken from, that is, from post-fader to pre-fader.
- Soloing inputs and outputs:

With solo A off there is no solo in operation.

Table 4: Solo A destination controls

<i>Control</i>	<i>Options</i>	<i>Description</i>
PFL direct input	-	Direct inject to solo A from linked console, active only while solo A is PFL.
AFL direct input	-	Direct inject to solo A from linked console, active only while solo A is AFL.
Solo add	<ul style="list-style-type: none"> <li>• On (additive solos)</li> <li>• Off (self-cancelling solos)</li> </ul>	Disable self-cancelling solo A solos. (When self-cancelling solos are selected, that is, with solo add mode off, the solo being cancelled will be deactivated before activating a new solo.)
Solo clear	<ul style="list-style-type: none"> <li>• On (some solo A solos)</li> <li>• Off (no solo A solos)</li> </ul>	Single button clearing of currently active solo A solos.
Solo PFL	<ul style="list-style-type: none"> <li>• PFL (solo pre-fader)</li> <li>• AFL (solo after-fader)</li> </ul>	Switch all current and future solo A activations to send the solo A bus pre-fader.
Solo in place (SIP)	<ul style="list-style-type: none"> <li>• On (SIP active)</li> <li>• Off (SIP inactive)</li> </ul>	<p>When active, SIP uses the console's master outputs for the solo A material. It does this by muting all input channels that are not currently soloed to the solo A bus.</p> <p>It is not possible to activate SIP accidentally. The SIP button has a hinged clear plastic cover that has to be lifted up before the button can be operated.</p> <p>For SIP purposes, master outputs can be the main master bus or, if configured, a multi-channel output mix. To be eligible for SIP muting, channels must be input channels and set up to solo to the solo A bus; channels with any other combination are not subjected to SIP muting.</p> <p>Channels eligible for SIP muting that are currently, or subsequently, muted by a means other than SIP (that is, local button press, auto-mute or scene recall) remain muted regardless of the SIP status. On removal of the overriding mute, the mute is restored according to the current SIP status.</p>

## Solo B

The solo B buttons are located next to the individual solo buttons (GUI only). With solo B on, solo goes to the B bus and with solo B off, solo goes to the A bus. Solo B has separate **ADD**, **CLEAR** and **PFL** controls that, in broadcast mode, can be used to control those functions independently of solo A.

## Solo hierarchy

The solo system add-mode hierarchy works as follows:

- The highest level of solos will be the inputs and returns. When active, these will override and inhibit the remaining solo sources, namely auxes, matrices and masters.
- Within the constraints of the two-level solo hierarchy, only one source can be active on any channel at any instant:
  - **Input channels:** Input channel <--> Aux AFL <--> Direct out <--> Side chain listen
  - **Return channels:** Return channel <--> Direct in
  - **Aux buses:** Aux bus <--> Direct in <--> Side chain listen
  - **Matrix outputs:** Matrix bus <--> Direct in <--> Side chain listen
  - **Master outputs:** Master bus <--> Direct in <--> Side chain listen

An additional constraint is placed on the side chain listen. This is due to the nature of the DSP, where only one side chain listen can be active on the console at any time, regardless of whatever else is active in the same solo hierarchy level.

- If an input channel solo is active via a VCA master solo, soloing the input temporarily overrides the VCA master solo.

## Solo in place (SIP)

Operating a solo button cuts all channels from the main mix except soloed ones; this is called “solo in place” or “SIP”. SIP allows you to check the contribution from soloed channels at the actual levels they occur in the mix, that is, taking into account the main fader setting. If solo buttons cut the main output (main mix) they must only be used in rehearsals.

### >> To activate SIP

- 1 Press the solo in place switch. A window will open containing the message “Activate SIP?”.
- 2 Click **OK**.

## Solo modes

There two available solo modes (see “Solo system” on page 112) as follows:

- **Normal** Solo A and B are treated as a single 4-channel solo bus, with the **ADD**, **CLEAR** and **PFL** controls in the monitor section linked together.
- **Broadcast** Switches all of the channels to solo B, selects the stereo masters for the solo A output and unlinks the **ADD**, **CLEAR** and **PFL** controls in the monitor section. This allows the main program material to be monitored at the same time as something soloed on the solo B bus.



## Chapter 13: Muting

Muting is useful for turning off channels you don't want to listen to. The channel mutes turn off outputs from the channel. See Appendix B "Functional Block Diagrams" for which outputs are affected when channel mute is active. Channel mutes can be activated by:

- Local press.
- Auto-mutes (see "Auto-mute (mute) groups" on page 147).
- VCAs (see "VCA and POPulation groups" on page 143).
- Scene recall (see Chapter 20 "Scenes And Shows (Automation)" on page 161).
- SIP, which uses the control centre's master outputs for solo A material by muting input channels currently soloed to the solo A bus. For SIP muting, channels must be input channels set up to solo the solo A bus.

All of the above mute activation methods, except VCAs, mute the channel outputs and update the channel mute status indicator.



## Chapter 14: Monitors And Communications

This chapter describes the monitoring and communications functions of the PRO2.

### Monitors (A and B)

To match the two-bus solo system there are two monitor outputs, A and B, which control their respective output levels. These are controlled from the monitor section on the master bay (see Figure 9 “Monitor A and B strips” on page 110). Each monitor output has:

- The ability to monitor mono and stereo outputs, and an external input.
- An external talkback input.
- A local monitor output.
- A headphone output.
- Delay compensation.
- Control of the solo buses.

Although the capabilities of both monitors are the same, monitor A is the primary output. They both have a fader control, and there are four balanced XLR outputs on the rear panel (see “Monitor and outputs/surround section” on page 268).

The monitor output controls *do not* have support from the screens and *are not affected by automation*.

The **monitor a** and **monitor b** meters monitor the peak signal levels of stereo left and right for both monitor paths. The metering capabilities of both monitors is the same.

#### >> To switch control of headphones to fader

Press **C/O**.

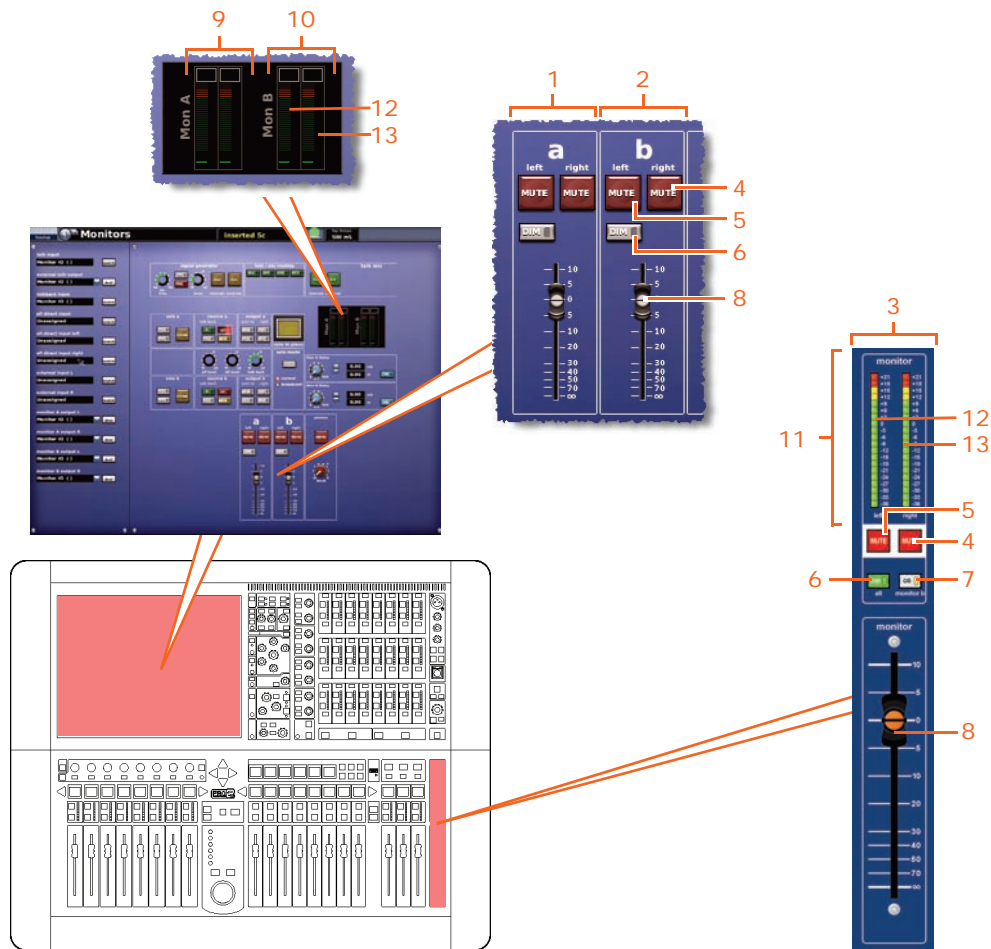

Figure 9: Monitor A and B strips

Item	Description
------	-------------

- |    |   |
|----|---|
| 1  | Monitor <b>a</b> strip on the GUI.  |
| 2  | Monitor <b>b</b> strip on the GUI.  |
| 3  | <b>monitor</b> a/b strip on the control surface. For controlling current monitor assignment (A or B).   |
| 4  | This <b>MUTE</b> button mutes the right monitor signal. On the control surface, it mutes the right monitor signal of the current monitor assignment (A or B).                           |
| 5  | This <b>MUTE</b> button mutes the left monitor signal. On the control surface, it mutes the left monitor signal of the current monitor assignment (A or B).                             |
| 6  | This <b>DIM</b> button dims the monitor signal output level by 20dB on monitor speakers. On the control surface, it dims the monitor signal of the current monitor assignment (A or B). |
| 7  | <b>C/O</b> switch that switches control of the monitor's fader and mute to monitor B. The <b>C/O (to fader)</b> switch (control surface only) swaps control of the solo A to fader.     |
| 8  | Fader for control of monitor A or B speaker level from $-\infty$ to +10.  |
| 9  | <b>left</b> and <b>right</b> meters for monitor <b>a</b> (GUI only).  |
| 10 | <b>left</b> and <b>right</b> meters for monitor <b>b</b> (GUI only).  |



<i>Item</i>	<i>Description</i>
<b>11</b>	<b>left</b> and <b>right</b> meters for the monitor (A or B) currently assigned to the <b>monitor</b> section on the control surface.
<b>12</b>	Left monitor signal. On the control surface, it is the left monitor signal of the current monitor assignment (A or B).
<b>13</b>	Right monitor signal. On the control surface, it is the right monitor signal of the current monitor assignment (A or B).

### Delay (GUI only)

You can delay each monitor output signal (A and B) individually by up to 500 milliseconds (ms). This is done via the two delay sections in the **Monitors** screen. This function does not have support on the control surface.

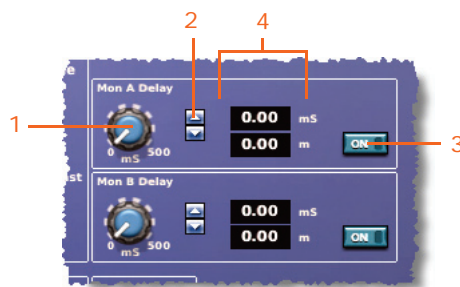

*Monitor A and B delay sections on the GUI*

<i>Item</i>	<i>Element</i>	<i>Description</i>
<b>1</b>	Control knob	Adjusts the monitor output signal delay in the range 0ms to 500ms.
<b>2</b>	Up/down spin buttons	Provide finer adjustment of the monitor output signal delay.
<b>3</b>	<b>ON</b> switch	Switches the delay on/off.
<b>4</b>	Two delay value fields	Show the current delay value in milliseconds (ms) and metres (m).

## Solo system

**solo a** and **solo b** system sections allow solo signals to be selected independently for each monitor system (A and B). These can be selected as AFL (**PFL** extinguished), PFL (**PFL** illuminated), additive (**ADD** enabled) or interlock cancelling.

The monitor outputs can be configured for normal or broadcast use and both modes change the interleaving logic between differing areas of the monitor output. A mode select button selects either of the two possible options.

Additionally, there is a **solo in place** switch for activating the SIP function.

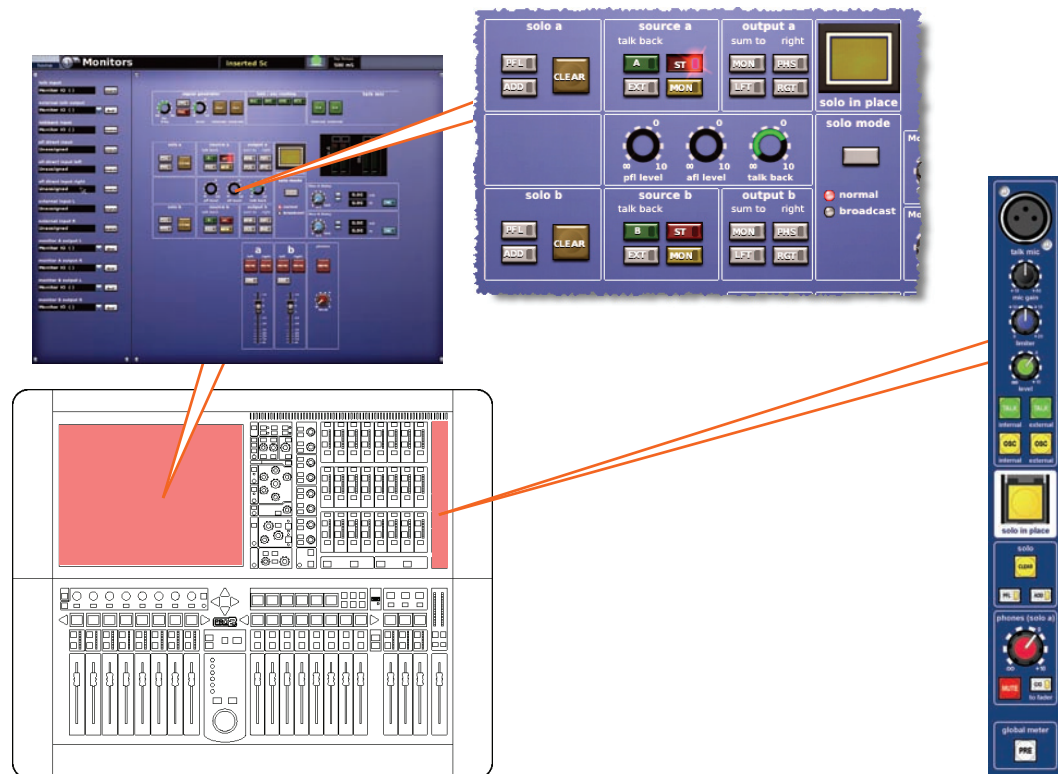

*Solo system controls on the control surface and GUI*

### solo in place switch

The **solo in place** (SIP) switch puts the control centre in SIP mode. In this mode, pressing a **SOLO** button in an input fast strip activates a mute of all other channels, assuming it is set to the appropriate monitor (A or B); talk back remains unaffected.

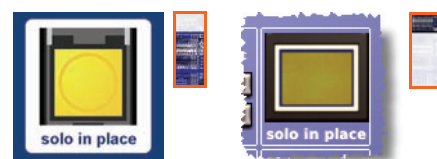

When SIP is switched on and an input is soloed, all unsoloed inputs are muted, except the auto-mutes. With SIP in operation, pressing a **SOLO** button in a VCA section (for a group) solos all group members, while muting non-group members. When SIP is switched off, any solos are kept active but the mutes are removed (except the ones with auto selected, which are left alone).

As this is an important function that may have detrimental consequences, the button on the control surface is protected by a plastic cover to prevent it being inadvertently switched on/off.

You can protect a channel from this function by switching on its mute safe (see "Safes" on page 285).

## &gt;&gt; To activate SIP

- 1 Do one of the following:
  - On the control surface, lift up the cover of the **solo in place** button and then press the button.
  - At the GUI, choose **home ▶ Monitors**. Then click **solo in place**.
- 2 In the “Activate SIP ?” message window, click **OK**.

## &gt;&gt; To deactivate SIP

Press/click the **solo in place** button (control surface or GUI).

## C/O switch

The **C/O (to fader)** switch (control surface only) swaps control of the headphone output and solo A output between the **phones (solo a)** control knob and the **monitor** fader.



## Monitor output (A and B)

The monitor output sections — **output a** and **output b** — have common controls for the monitor A and B sections (GUI only). The monitor's output level is controlled by a non-automated fader, a **DIM** switch and left and right mutes (see Figure 9 “Monitor A and B strips” on page 110).

The buttons in each output section have an integral LED for on/off indication, and have the following functions:

- **MON** switch, sums left and right signals, but with a  $\pm 3\text{dB}$  loss. With  $0\text{dB}$  on monitor A left and nothing on monitor A right, pressing **MON** gives  $-3\text{dB}$  on both monitor A left and monitor A right. However, with  $0\text{dB}$  on both monitor A left and monitor A right, pressing **MON** gives  $+3\text{dB}$  on them both.
- **PHS** phase reverse switch, reverses the phase of the right monitor signals.
- **LFT** and **RGT** switches, route left and right monitor signals, respectively, to both left and right monitor speaker outputs. These switches can be used in combination, as shown in Table 5 below.



**Table 5: Monitor signal routing**

<i>LFT</i> <i>button</i>	<i>RGT</i> <i>button</i>	<i>Monitor signal routing</i>
Off	Off	Left and right monitor signals are routed normally, that is, left monitor signal is routed to the left monitor speaker output, and the right one is routed to the right monitor speaker output.
On	Off	Left monitor signal is routed to both of the monitor speaker outputs.

<i>LFT</i> <i>button</i>	<i>RGT</i> <i>button</i>	<i>Monitor signal routing</i>
Off	On	Right monitor signal is routed to both of the monitor speaker outputs.
On	On	Left and right monitor signal routing is swapped over, that is, left monitor signal is routed to the right monitor speaker output, and the right one is routed to the left monitor speaker output.

### source (a and b) sections

The **source a** and **source b** sections contain monitor input selector switches. On both the A and B systems, these define the source for the monitor section from the possible 'primary' choice of stereo master (**ST**), mono master (**MONO**) or external (**EXT**). Additionally, each section has a talkback switch.

The function of the buttons in each source section is as follows:

- Talk **A** and **B** switches, sum the talk back signals to the solo bus. The **talk mic** section (see "Talk mic" on page 118) has a level control knob that is shared between the two monitor paths.
- **ST** switch, routes post-fader stereo master mix to stereo local monitor outputs.
- **EXT** switch, routes stereo external input (two-track return etc.) to stereo local monitor outputs.
- **MON** switch, routes post-fader mono masters mix to stereo local monitor outputs.



### solo (a and b) sections

The solo signals can be selected for each monitor system (A and B) to be AFL, PFL, additive or interlock cancelling. PFL and AFL audio buses may accept injected external signals, and two control knob level controls make adjustments.

PFL and AFL levels are adjustable via the **pfl level** and **afl level** control knobs; see "solo system section" on page 115.

The function of the buttons in each solo section is as follows:

- **PFL** switch, sends mono pre-fader listen (PFL) solo bus signals to headphones and local monitor outputs. With PFL switch disabled (LED extinguished), stereo after fader listen (AFL) solo bus signals are sent to headphones and local monitor outputs.
- **ADD** switch, allows multiple channel access to solo buses. When solo add mode is off, pressing a solo switch cancels any currently active solos. Multiple solos (for example, stereo left and right signals) can be monitored in this mode provided solo switches are pressed at approximately the same time. When solo add mode is on, auto-cancelling is defeated, which allows multiple channel or output soloing. In this mode, input solos have priority over output solos and VCA solos, and will temporarily override them. When input solo is cancelled, output solo or VCA solos will return.
- **CLEAR** switch, illuminates when a solo switch is active in its monitor section and, when pressed, clears any solo switches in that section.



### solo mode section

On the GUI, the **solo mode** section has a select button by which you can select one of the following options. The LEDs to the left of the options illuminate to show which option is in operation.

- **normal** — both solo systems (A and B), are active and behave as a single solo system.
- **broadcast** — routes stereo masters to the monitor A output and activates all the solo B controls so that soloed material is routed to the monitor B outputs. This allows the master outputs to be continually broadcast (probably the on-air program), while the other material is soloed.



### solo system section

The **solo system** section has three control knobs, as follows:

- **pfl level** control knob — PFL audio bus may accept injected external signals. This control knob adjusts the pre-fader level in the range infinity ( $\infty$ ) to +10dB.
- **afl level** control knob — AFL audio bus may accept injected external signals. This control knob adjusts the after-fader level in the range infinity ( $\infty$ ) to +10dB.
- **talk back** control knob — adjusts the talk back level, in the range infinity ( $\infty$ ) to +10dB.



The following four sections in the **Monitors** screen allow you to patch the solo system signals.

- talkback input
- pfl direct input
- afl direct input left
- afl direct input right

For routing details, see Table 25 "Navigating to the Patching screen" on page 418.

## Signal generator

The **signal generator** section can output to pink noise (pink noise generator) or sine wave tone (sinusoidal oscillator), and connect to the internal and external talk buses.

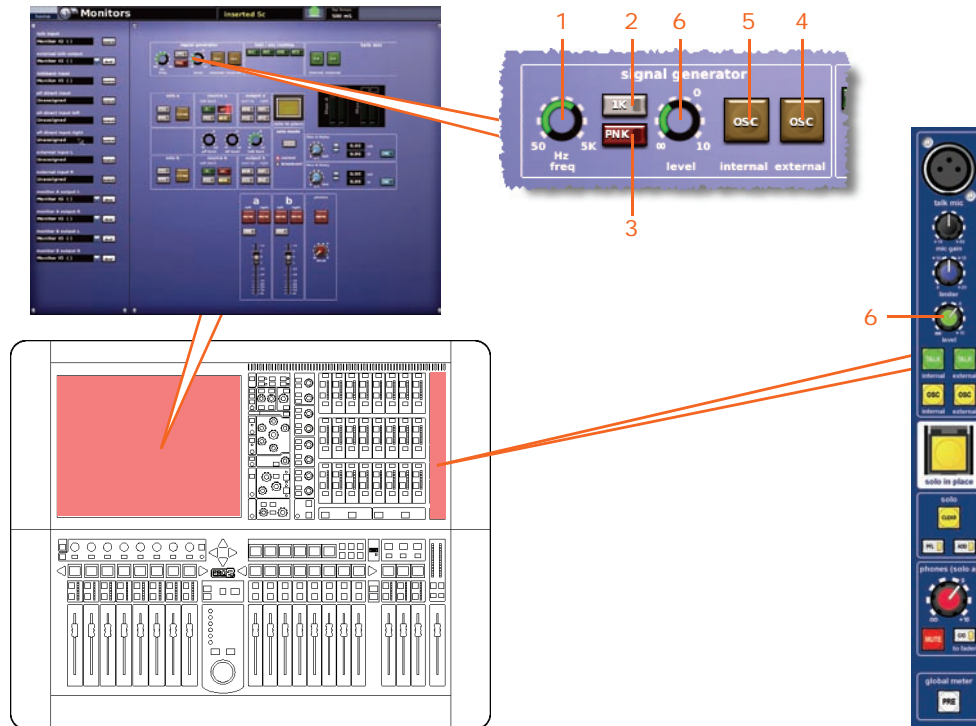

Signal generator controls on the control surface and GUI

Item	Element	Description
1	freq control knob	Gives continuous adjustment of the sinusoidal oscillator frequency from 50Hz to 5kHz.
2	1K switch	Overrides the swept frequency control (item 1) and provides a fixed 1kHz tone.
3	PNK switch	Overrides the sinusoidal oscillator and converts output signal to pink noise.
4	OSC (external) switch	This OSC external switch connects signal generator output to talk external output XLR.
5	OSC (internal) switch	This OSC internal switch connects signal generator output to the control centre's internal talk and talk select buses. The internal talk bus can then be mixed onto any of the control centre's buses by pressing the internal talk switches associated with those buses, or mixed onto a group of buses by activating an internal talk group (see "Talk osc/routing" on page 117).
6	level control knob	Gives continuous adjustment of signal generator peak output signals from off ( $\infty$ ) to +10dB.

The **OSC** switches (internal and external) are the talk routing switches.



## Talk osc/routing

The **talk / osc routing**, or 'internal talk groups' section, sends signal generator and talk mic signals to buses within the control centre. It contains four talk group switches used for selecting the destination of the talk and OSC internal signals. The GUI has an additional four configuration switches for programming.

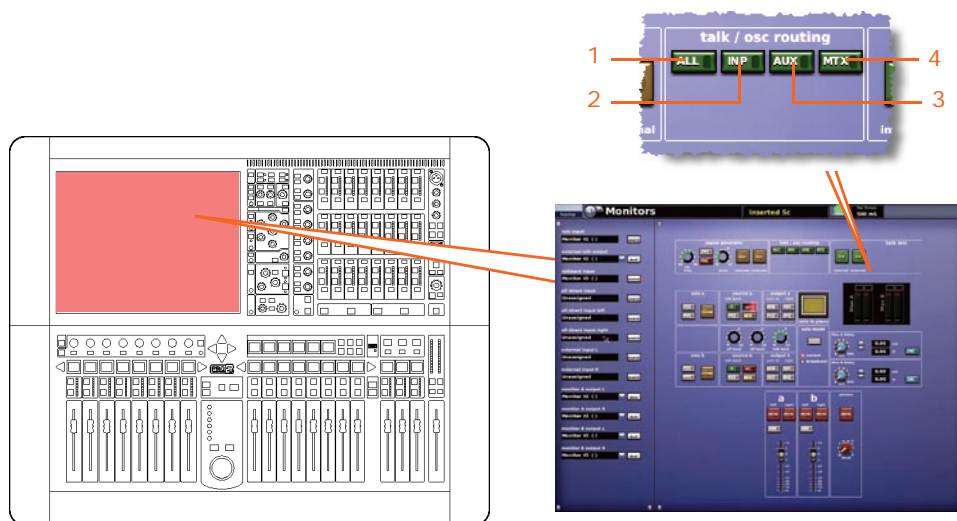

Talk osc/routing controls on the control surface and GUI

Item	Element	Description
1	<b>ALL</b> switch	Routes the talk/OSC internal signal to all outputs.
2	<b>INP</b> switch	This input switch routes the talk/OSC internal signal to the input section.
3	<b>AUX</b> switch	Routes the talk/OSC internal signal to all auxes.
4	<b>MTX</b> switch	This matrix talk switch routes the oscillator or talk signal to the matrix outputs.

## Internal talk groups

You can assign talkback or send test signals to any audio bus on the control centre. The preset 'talk' groups allow you to, for example, talk to groups of performers in a monitor mix or make group announcements. Also, by using the internal tone oscillator, you can perform signal path testing and equipment alignment.

There are four 'talk' groups available, which are operated via the GUI. The preset talk groups let you can route to all inputs, all auxes, all matrices or all outputs.

Before you can select a talk group, the **TALK/internal** and/or **OSC/internal** buttons must be switched on. (This also applies to generator routing.) Also, if any internal talk or osc generator routing is active when the **TALK/internal** and/or **OSC/internal** buttons are both switched off, this routing is cancelled.

When a talk group is activated, all talk group member functions are activated.

### >> To activate a talk group

- 1 Make sure either one or both of the 'internal' buttons, that is, the **TALK (internal)** button in the **talk mic** section and the **OSC (internal)** button in the **signal generator** section, are on.
- 2 Click the desired talk/oscillator routing button.

## Talk mic

The control surface has an internal talk mic that lets you talk to external locations, and you can also be talked *to* from an external location.

For the input and output talk connections, see “talk section” on page 268.

### Internal talk mic

This is located in the **talk mic** section, and contains the controls for both the internal talk mic and external talkback functions, which control a talkback microphone connected to the DL251/DL252 Audio System I/O. The talk mic utilises the compressor (limiter), which is in the microphone signal path immediately before the talk level control.

The outputs from the internal mic can be connected to the internal talk bus/talk external XLR output (see Appendix B “Functional Block Diagrams”).

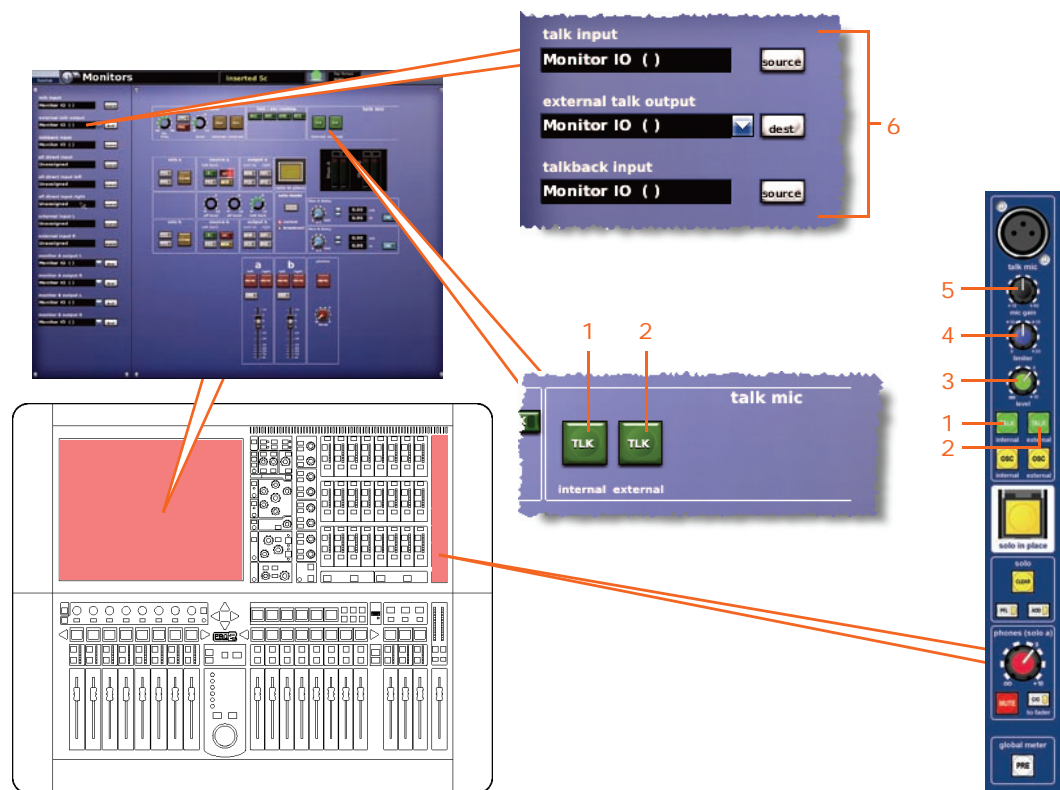

Talk mic controls on the control surface and GUI

Item	Element	Description
1	TALK/[TLK] (internal) switch	This talk internal switch connects the talk mic output to the control centre’s internal talk system. The internal talk bus can then be mixed onto any of the control centre’s buses by pressing the internal talk switches associated with those buses, or mixed onto a group of buses by activating an internal talk group (see “Talk osc/routing” on page 117).
2	TALK/[TLK] (external) switch	This talk external switch connects the talk mic output to the talk external output XLR.
3	level control knob	Gives continuous adjustment to the post-limiter signal from off ( $\infty$ ) to +10dB.



<i>Item</i>	<i>Element</i>	<i>Description</i>
4	<b>limiter</b> control knob	Gives continuous adjustment of the peak limiter value from 0dB to +20dB.
5	<b>mic gain</b> control knob	Provides continuous mic amplifier gain adjustment of the mic connected to mix bay control surface. Range is +15dB to +60dB and operates in conjunction with the peak limiter.
6	Talk patching sections.	See Table 25 "Navigating to the Patching screen" on page 418.

The three control knobs are used in conjunction with mic XLRs (in the screen housing and the rear connector panel) and the two **TALK** routing switches (internal and external).

#### >> To select the internal talk mic

- 1 In the **talk mic** section of the master bay, press **TALK (internal)** to switch in the talk mic section (see "Talk mic" on page 118).
- 2 In the **source a** or **source b** section of the master bay, press **TALK**. Your chosen section will determine which system bus (A or B) the talk mic will be sourced from (see "Monitor output (A and B)" on page 113 and "source (a and b) sections" on page 114).

#### External talkback

The external talkback input is a mic/line input at the stage end of the system that, when enabled in the monitor section (see "Monitor output (A and B)" on page 113), can mix onto the local monitor outputs.



## Chapter 15: Graphic Equaliser (GEQ)

This chapter describes the internal GEQs of the PRO Series. Initially, it explains how to use the PRO2 Control Centre to configure and operate the GEQs and then details all of their available control functions.

### Overview of the GEQs

The PRO2 Control Centre incorporates a graphic equaliser (GEQ), which is closely based on the Klark Teknik DN370 Graphic Equaliser (see Appendix C "Klark Teknik DN370 GEQ" for details). You can configure the PRO2 Control Centre to have set numbers of these GEQs up to a maximum of 28, and these are mutually inclusive of the number of effects you can have. For example, you can have three effects and 20 GEQs, but if you want five effects you can only have 12 GEQs.

Each GEQ is a single-channel, 31-band, third octave graphic equaliser, and GEQ features switched 2nd order high pass and low pass filters and two notch filters with variable frequency ranges.

The GEQ is primarily a mono process, but in the case of stereo groups or mix channel outputs, a stereo GEQ is controlled from a single set of controls.

The GEQs are managed via a virtual eight-unit rack on the **Graphic EQs** screen. From here you can open the window of any GEQ, which gives you full control over it.

### About the Graphic EQs screen

The main sections of the Graphic EQs screen comprise:

- **GEQ patching source** The border to the left each GEQ unit will display its source, if patched. In the diagram above, GEQ 1 has been patched to "AS3" (aux 3).
- **GEQ rack overview** This section contains an overview of the total number of GEQ racks in use, and also aids GEQ navigation/selection. The number of racks (up to four) is dependent on configuration and the currently selected rack is highlighted in yellow (as is the currently selected GEQ unit).
- **GEQ rack** A 'virtual' rack containing up to eight GEQs. The rack also includes **STORE PRESET** and **LOAD PRESET** user library buttons (see Chapter 24 "User Libraries (Presets)" on page 235).

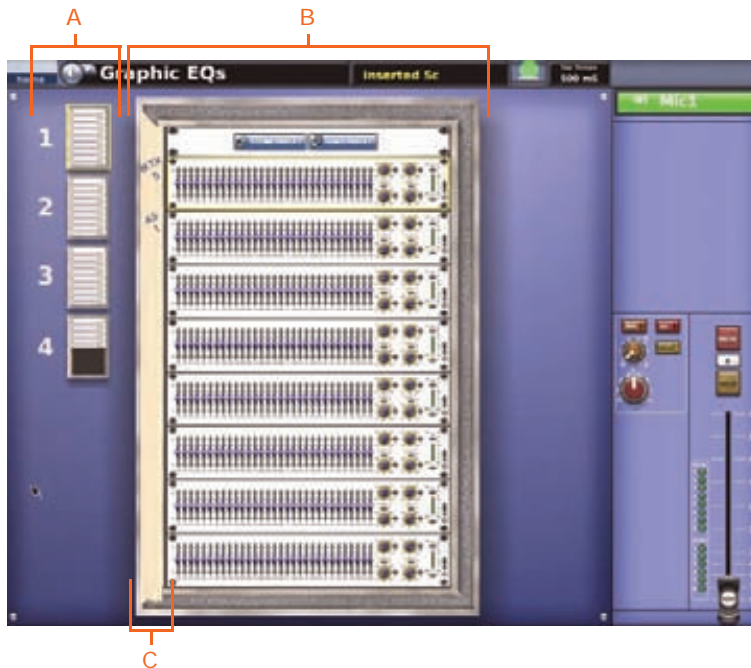

**Graphic EQs** screen (configured for 28 GEQs)

**A.** GEQ rack overview **B.** GEQ virtual rack **C.** GEQ patching source

#### >> To open the Graphic EQs screen

Do one of the following:

- At the GUI, choose **home ▶ Rack Units ▶ Graphic EQs**.
- In the navigation zone, press the **effects/graphics** access button twice.

#### >> To open a GEQ rack

Do one of the following:

- In the **Graphic EQs** screen, click on the desired unit.
- Press **ENTER** in the **assignable controls** section.

## About the GEQ window

In the centre of the GUI screen, the GEQ window shows the selected GEQ's front panel. This gives you full control of the GEQ via the GUI controls in the navigation zone by using the trackball and left and right buttons. Below the GEQ is an **assignable controls** panel that lets you select and control the GEQ faders (singly or in groups) and the controls on the right.

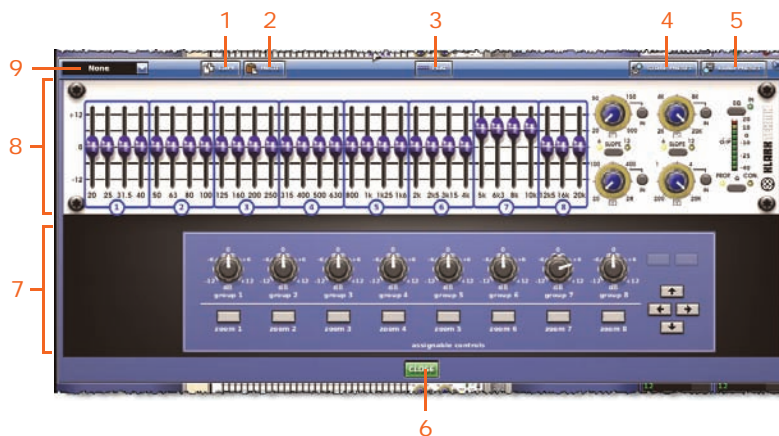

GEQ window

Item	Element	Description
1	<b>COPY</b> button	Copy and paste function button (see Chapter 18 "Copy And Paste" on page 185).
2	<b>PASTE</b> button	Copy and paste function button (see Chapter 18 "Copy And Paste" on page 185).
3	<b>FLAT</b> button	Sets all of the GEQ's faders to 0dB.
4	<b>STORE PRESET</b> button	See Chapter 24 "User Libraries (Presets)" on page 235.
5	<b>LOAD PRESET</b> button	See Chapter 24 "User Libraries (Presets)" on page 235.
6	<b>CLOSE</b> button	Closes the GEQ window.
7	<b>assignable controls</b> panel	See Chapter 19 "Assignable Controls (I Zone)" on page 187.
8	GEQ panel	Shows the front panel of the GEQ (see "GEQ front panel features" on page 124).
9	Drop-down list	For selecting the source of the GEQ.

### >> To open a GEQ unit window

In the **Graphic EQs** screen, click on a non-control area of the unit you want.

## &gt;&gt; To patch a source to a GEO

- 1 Open the window of the GEO.
- 2 Open the GEO source drop-down list. (An unpatched GEO will have "None" displayed in the text field.)
- 3 In the drop-down list, click the source you want. For example, "Aux Send 3". The new patching assignment will appear in the source name field (as shown right) and in the border on the left of GEO panel.
- 4 Click **CLOSE** to accept the change and close the GEO's window.

The new GEO patching source assignment will appear in the virtual rack.

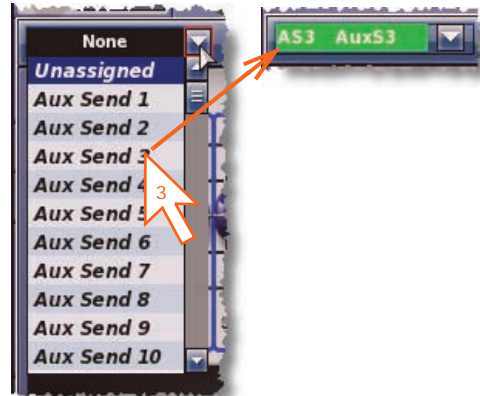

## GEO front panel features

The front panel of the GEO, as displayed on the GUI, represents the Klark Teknik DN370 Graphic Equaliser. It includes a graphic EQ (faders) section and a filters section.

Thirty one faders provide fine adjustment of each frequency band. The 31 frequency bands are spaced 1/3 octave apart on the standard ISO 266 frequency centres. All the functions of the GEO can be bypassed via an **EQ** switch, such that the output will be the same as the input.

The GEO has one high pass filter, one low pass filter and two variable frequency notch filters. Each filter is adjusted via a control knob on the GUI screen. To addition the effect of the filters, use either the **EQ** switch (which will also bypass the GEO) or the individual filter switch.

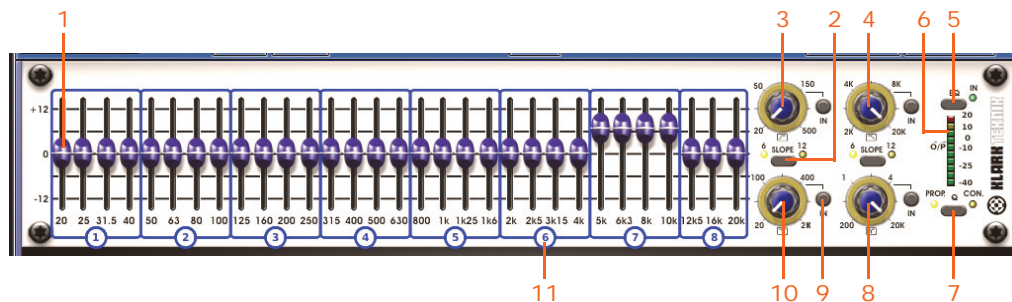

GEO front panel

Item	Control	Function
1	Fader (31-off).	Adjusts signal level.
2	<b>SLOPE</b> button	Switches the high or low pass filter between 6dB and 12dB. Adjacent yellow LEDs indicate the active mode.
3	High pass filter control knob	Adjusts the cut off frequency, which is continuously variable from 20Hz to 500Hz.
4	Low pass filter control knob	Adjusts the cut off frequency, which is continuously variable from 2kHz to 20kHz.

<i>Item</i>	<i>Control</i>	<i>Function</i>
5	<b>EQ</b> button	Selects the EQ. The adjacent green <b>IN</b> LED shows the EQ is on (illuminated) or is being bypassed (extinguished).
6	10-segment meter	Shows the incoming signal level and is pre-EQ (but post-gain control). The LED functions are: two red LEDs illuminate when signal has exceeded +20dBu; two yellow LEDs illuminate when signal level exceeds 0dB (range is between 0dB to +20dB); and the top five green LEDs encompass the signal level range of between 0dB and -40dB, while the bottom one illuminates when the signal has exceeded -40dB.
7	<b>Q</b> button	Selects proportional Q ( <b>PROP.</b> ) or constant Q ( <b>CON.</b> ) modes.
8	Notch filter control knob	Adjusts the position of the notch filter within the range 200Hz to 20kHz.
9	<b>IN</b> button	Switches the respective high pass/low pass/notch filter in/out.
10	Notch filter control knob	Adjusts the position of the notch filter within the range 20Hz to 2kHz.
11	Fader group ID number	See "Controlling a GEQ via the I zone" on page 194.

## Configuring the number of GEQs (and effects)

GEQ (and effects) configuration is a GUI-only operation. We recommend that you configure the number of GEQs and effects before you start using the PRO2 Control Centre.

>> **To configure the PRO2 Control Centre with the number of GEQs and effects**

- 1 At the GUI, choose **home ▶ Preferences ▶ General**.
- 2 Click the **Show** tab to open the **Preferences Show** window.
- 3 In the **Effects and GEQs** section, open the drop-down list (as shown right).
- 4 Click on your desired option to select it. For example, click the **3 Effects - 20 GEQs** option to have three internal effects and 28 GEQs.

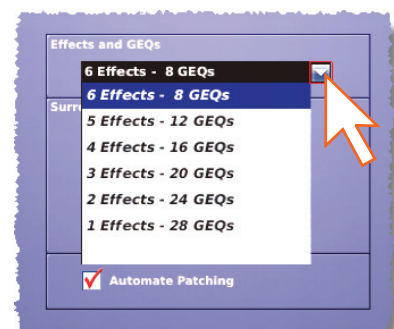

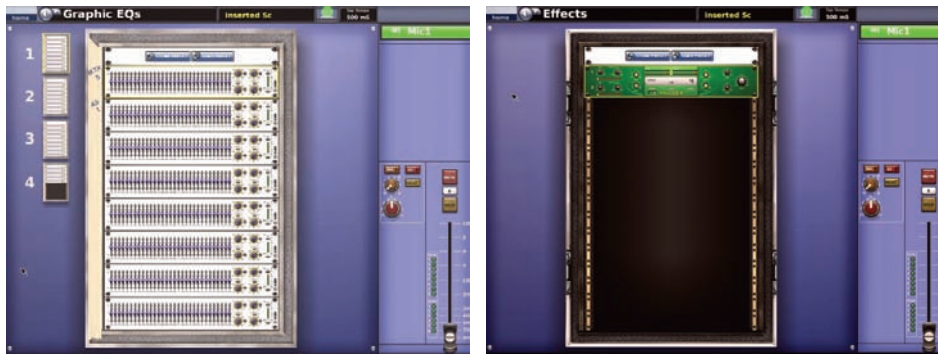

Typical example of how the **Graphic EQs** and **Effects** will look screens when PRO2 is configured with the **1 Effect - 28 GEOs** option.

## Copying settings between GEOs

You can copy and paste all the settings of one GEO to another.

### >> To copy the settings of one GEO to another GEO

- 1 In the GEO rack of the **Graphic EQs** screen, open the window of the GEO that you want to copy the settings from.
- 2 In the GEO window, click **COPY**.
- 3 Close the GEO window and then open the window of the GEO that you want to paste the settings to.
- 4 In the GEO window, click **PASTE**.



## Chapter 16: Internal Effects

This chapter describes the internal effects of the PRO2. Initially, it explains how to use the PRO2 Control Centre to operate the effects and then details all of their available control functions and their use.

### Overview of the internal effects

The **Effects** screen manages up to six user-assignable effects devices, which are a 'bundle' of onboard creative audio effects that provide onboard facilities where outboard effects units would have traditionally been required. The effects are displayed on the screen in a 'virtual' eight-unit rack.



Typical **Effects** screen

All of the points in the control centre's signal flow where outboard effects can be inserted, such as auxes and returns or insert points on input channels, audio subgroups, mix and master buses, can be patched to effects in the internal effects as well as external world XLRs. The following table shows the available internal effects and where they can be found in this chapter.

<i>Internal effect</i>	<i>Section reference</i>
Delay	"Delay effect" on page 130
Virtual DN780 Reverb	"Virtual DN780 Reverb effect" on page 132
Flanger	"Flanger effect" on page 134
Phaser	"Phaser effect" on page 135
Pitch Shifter	"Pitch Shifter effect" on page 137
SQ1 Dynamics	"SQ1 Dynamics effect" on page 138
Stereo 3-Band Compressor	"3-Band Compressor effect" on page 139
Dynamic EQ	"Dynamic EQ" on page 140

### Rack unit number allocation

Each unit position in the rack is allocated a rack number that is recognised by the PRO Series Live Audio System (shown right).



### About the effect window

Similarly to the GEQ window on the GUI, the effect window shows a screen-width version of the selected effect, which gives you full control of the effect via the trackball and left and right buttons in the navigation zone. A 'virtual' **assignable controls** panel below lets you select and operate the controls of the effect.



Effect window

Item	Element	Description
1	<b>CHANGE DEVICE TYPE</b> button	Lets you select a different effect.
2	<b>STORE PRESET</b> button	User library function button (see Chapter 24 "User Libraries (Presets)" on page 235).
3	<b>LOAD PRESET</b> button	User library function button (see Chapter 24 "User Libraries (Presets)" on page 235).
4	<b>CLOSE</b> button	Closes the effect window.
5	<b>assignable controls</b> panel	See Chapter 19 "Assignable Controls (I Zone)" on page 187.

<i>Item</i>	<i>Element</i>	<i>Description</i>
<b>6</b>	Effect panel	For details of the front panel for each effect, refer to the effect sections later on in this chapter.
<b>7</b>	Effect name	For naming the effect.

#### >> To open an effect window

In the **Effects** screen, click on a non-control area of the effect you want.

## Working with the effects

There are a number of ways of handling the effects, such as setting up, configuration and operation, all of which involve the use of the GUI. However, most of these methods can also be carried out using the I zone; see Chapter 19 "Assignable Controls (I Zone)" on page 187.

#### >> To open the Effects screen

Do one of the following:

- At the GUI, choose **home ▶ Rack Units ▶ Effects**.
- In the navigation zone, press the **effects/graphics** access button.

#### >> To operate an effect control

The method for controlling the effect controls is the same as for any control on a GUI screen. For details, see "About GUI operation" on page 21.

#### >> To configure an effect

Similarly to the input channels, output channels, groups etc., you can change the name of an effect and the background colour of its text field, as it appears on the GUI (see "Configuring VCA/POP groups" on page 49).

#### >> To change an effect type

For details, see "To choose an effect" on page 54.

#### >> To route an effect

Effects are patched via the Patching screen. For details, see Chapter 7 "Patching" on page 35.

## Effect programs

Some types of effect have associated factory presets and user-configurable programs, which you can load within the effect (these are also stored in a show file). You can also save all of the controls from one or more effects in a user preset, which will then contain information about their settings, including the loaded factory preset or user-configurable program.

For details of each effect type, refer to its section in this chapter. For information on presets, see Chapter 24 "User Libraries (Presets)" on page 235.

## Delay effect

The delay effect provides simple delay line based effects. Delay times can be specified manually or by means of a 'tempo-tap' button. Three-mode delay algorithm:

- **Single** — one delay tap (mono or stereo processing).
- **Dual** — two delay lines (stereo insert only).
- **Ping-pong** — two delay lines with cross feedback.



Front panel of the delay effect

Item	Control	Function
1	<b>BPM Sync</b> button	Activates BPM (TAP TEMPO) mode.
2	Left channel delay time control knob	For entering the desired delay time. Value is shown immediately below, in ms or note duration.
3	<b>Range</b> button	Selects one of three delay time ranges (1-25ms, 10-200ms or 80-1600ms). Value is displayed immediately below/above button.
4	<b>Link</b> button	Links delay time of left and right channels.
5	<b>Pan</b> control knob	Pans channel between L (left) and R (right) outputs.
6	<b>Level</b> control knob	Adjusts the output level. Range is from off to +10dB.
7	<b>Feedback</b> control knob	Adjusts the amount of negative/positive feedback applied to delay. Controls the number of repeats. Range is from -100% to +100%.
8	<b>Blend</b> control knob	Adjusts the feedback blend from <b>norm</b> to <b>cross</b> .
9	<b>Depth</b> control knob	Adjusts depth of delay modulation. Range is from 0 to 100.
10	<b>Damping</b> section	Contains a <b>HF</b> control knob that adjusts the HF attenuation of delay repeats and an <b>LF</b> control knob that adjusts the LF attenuation of delay repeats.
11	<b>EQ</b> section	Contains a <b>HI</b> control knob that adjusts the amount of HF (high EQ) cut or boost applied to the output. <b>LO</b> control knob adjusts the amount of LF (low EQ) cut or boost applied to the output. Range of both is -12 to +12, with 0 at top dead centre.
12	<b>Rate</b> control knob	Adjusts rate of delay modulation. Range is between 0.001Hz and 10Hz, with 0.7Hz at top dead centre.

---

<i>Item</i>	<i>Control</i>	<i>Function</i>
13	<b>Model</b> select button	Selects digital or analogue delay model. Current selection is shown by the illumination of one of the LEDs above ( <b>Dig.</b> or <b>Anlg.</b> ).
14	<b>ON</b> switch	Switches the delay effect on/off.
15	<b>Gain</b> control knob	Adjusts the amount of gain between -20 and +20, with 0 at top dead centre.
16	<b>Mix</b> control knob	Adjusts the mix between dry (0%) wet (100%).
17	<b>HF Depth</b> control knob	Adjusts depth of HF damping modulation. Range is 0 to 100, with 50 at top dead centre.
18	Right channel delay time control knob	For entering the desired delay time (in ms).
19	<b>Tempo</b> control knob	Adjusts the tempo in tempo mode. Range is from 60 to 240 beats per minute (bpm).
20	<b>Tap</b> button	For manually tapping the tempo once the unit is in <b>BPM Sync</b> (TAP TEMPO) mode.

---

## Virtual DN780 Reverb effect

The Virtual DN780 Reverb provides emulation of the vintage Klark Teknik DN780 Digital Reverberator/Processor unit. The DN780 is not just a reverberation device, it also gives the user a unique and flexible means of producing realistic acoustic simulations for environments of all types and sizes. The provision of effects programs further extends this versatility, making it a very powerful acoustic processing package.

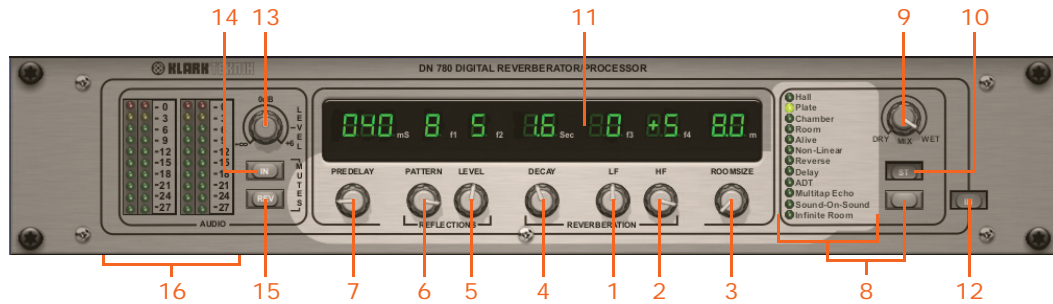

Front panel of the reverb effect

Item	Control	Function
1	LF (low frequency) control knob	<b>REVERBERATION</b> section control that adjusts the decay time at the low end of the reverb spectrum. Range is from -7 to +7.
2	HF (high frequency) control knob	<b>REVERBERATION</b> section control that adjusts the decay time at the high end of the reverb spectrum, which sets the absorption characteristic of the simulated space. Range is from -7 to +7.
3	<b>ROOMSIZE</b> control knob	Adjusts the average dimension of the simulated space. Range is from 8 to 90 metres. A momentary mute is implemented when this control is adjusted.
4	<b>DECAY</b> control knob	<b>REVERBERATION</b> section control that sets the overall (mid-band) reverberation decay time. Range is from 0.1 to 18 seconds, depending on room size.
5	<b>LEVEL</b> control knob	<b>REFLECTIONS</b> section control that acts as a 'depth' control by altering the apparent distance between the sound source and the listener. Alternatively, adjusts the input level for <b>Sound-On-Sound/Infinite Room</b> . Range is from 0 to 9.
6	<b>PATTERN</b> control knob	<b>REFLECTIONS</b> section control that controls the 'density' of early reflections. Selects the number and spacing of Early Reflections/ADT/Multi-tap delays. Range is from 1 to 9.
7	<b>PRE DELAY</b> control knob	Controls the amount of delay (in milliseconds) between the initial signal and the onset of reverberation. On certain program types, pre-delay is inserted between early reflections and reverb to improve authenticity. Its range is algorithm dependent.
8	List of algorithms and algorithm select button	Low level, phase-dependent 'clicks' are produced when pre-delay is altered during the program.  These algorithms emulate the ones on the original DN780. Use the select button to scroll through the list to select the one you want.

<i>Item</i>	<i>Control</i>	<i>Function</i>
9	<b>MIX</b> control knob	Controls the <b>DRY/WET</b> output mix and ranges from 0% to 100%, respectively.
10	<b>ST</b> stereo input button	Enhances original algorithm to provide stereo input.
11	Parameter display panel	Shows the current settings for the selected algorithm.
12	<b>IN</b> button	Switches in the Virtual DN780 Reverb effect.
13	<b>LEVEL</b> control knob	<b>AUDIO</b> section control for adjusting the input level.  Range is from $-\infty$ to +6dB, with 0dB at top dead centre. This should be set to illuminate the -3dB LED on the input headroom indicator during loud program passages.
14	<b>IN</b> button	<b>AUDIO</b> section <b>MUTES</b> control for removing feed to the reverberation section, enabling the decay qualities of the chosen setting to be confirmed.
15	<b>REV</b> button	<b>AUDIO</b> section reverb <b>MUTES</b> control for providing a rapid means of removing unwanted sounds.
16	Input headroom indicator	<b>AUDIO</b> section meters, which comprise two dual-column peak reading LED meters, ranging from 0dB to -27dB in 3dB steps. Each column consists of 10 coloured LEDs. The red LED illuminates at 3dB before the clipping point, which also provides an over-range warning for the arithmetical processor.

The parameter controls give accurate adjustment of all reverberation parameters and allow the engineer to create unique acoustic environments of virtually any type.

For more information on the Klark Teknik DN780, see Appendix D "Klark Teknik DN780 Reverb".



## Flanger effect

The flanger effect consists of one or, if configured as stereo, two dual-tap delay lines. One tap is fixed and the other tap position is modulated to provide 'thru-zero' flanging or single tap modulation when 'thru-zero' is off.



Front panel of the flanger effect

Item	Control	Function
1	<b>Delay</b> control knob	Adjust length of modulated delay line in milliseconds. In 'thru-zero' mode, also sets the delay of the dry path. Range is 0.1 to 10, with 5 at top dead centre.
2	<b>ON</b> button	Switches the flanger effect on and off. Illuminates when power is on.
3	<b>Feedback</b> control knob	Adjusts the amount of negative/positive feedback applied to the flanger. Range is from -100% to +100%, with 0% at top dead centre.
4	Modulation meter	A single row of 37 yellow LEDs are used to show the modulation.
5	<b>Out</b> meters	Two rows of 15 green LEDs, one each for L (left) and R (right).
6	<b>In</b> meters	Two rows of 15 green LEDs, one each for L (left) and R (right).
7	<b>Gain</b> control knob	Adjusts the signal level in dB. Range is from -20dB to +20dB, with 0dB at top dead centre.
8	<b>Invert</b> switch	Inverts the wet signal.
9	<b>Mix</b> control knob	Adjusts the mix between dry (0%) wet (100%).
10	<b>Hi EQ</b> control knob	<b>Filters</b> section control for adjusting the amount of HF (high EQ) cut or boost applied to the effect output (in dB). Range is -12dB to +12dB with 0dB at top dead centre.
11	<b>Lo EQ</b> control knob	<b>Filters</b> section control for adjusting the amount of LF (low EQ) cut or boost applied to the effects output (in dB). Range is -12dB to +12dB with 0dB at top dead centre.
12	<b>HF</b> control knob	<b>Damping</b> section control for adjusting the high frequency (kHz) tuning of flanger feedback. Range is 1kHz to 20kHz, with 10kHz at top dead centre.
13	<b>LF</b> control knob	<b>Damping</b> section control for adjusting the low frequency (kHz) tuning of flanger feedback. Range is 20Hz to 1kHz, with 140Hz at top dead centre.



Item	Control	Function
14	Depth control knob	<b>LFO Sweep</b> section control for adjusting the intensity of the effect by setting the depth of modulation as a percentage. Interactive with Delay, as for Chorus. Range is 0% to 100%.
15	Thru Zero switch	<b>LFO Sweep</b> section control for selecting 'thru zero' or normal mode. Illuminates to indicate switch is on.
16	Spread control knob	<b>LFO Sweep</b> section control for setting the relative phase of left/right modulation. Range is 0 to 180, with 90 at top dead centre.
17	Shape control knob	<b>LFO Sweep</b> section control for adjusting the shape of the modulation waveform. Range is from Tri (triangle) to Exp (exponential).
18	Rate control knob	<b>LFO Sweep</b> section control for adjusting the rate of modulation (Hz). Range is between 0.01 and 50, with 0.7 at top dead centre.

## Phaser effect

The phaser effect consists of one, or if configured for dual operation, two stereo phasers connected in serial/parallel according to mode setting.

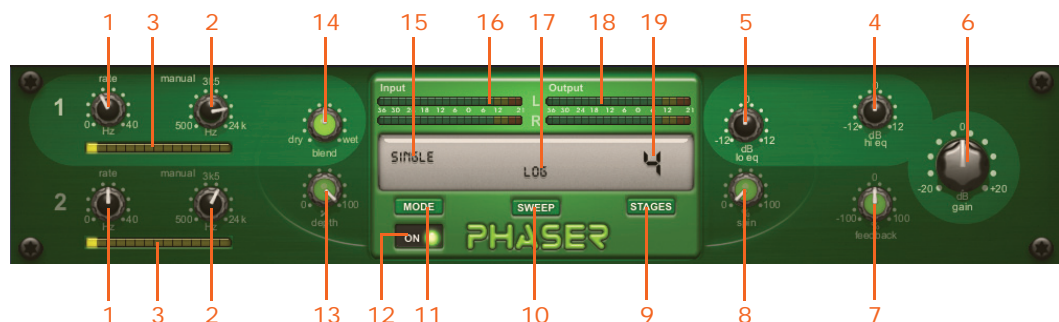

Front panel of the phaser effect

Item	Control	Function
1	rate control knob (channels 1 and 2)	Controls the rate of modulation in Hz. Range is from 0Hz and 40Hz.
2	manual control knob (channels 1 and 2)	Sets the sweep offset or performing manual sweep. Range is from 500Hz to 24kHz, with 3k5Hz (3,500Hz) at top dead centre.
3	Modulation meter	A single row of 15 yellow rectangular LED segments are used to show the modulation on each channel.
4	hi eq control knob	Adjusts the amount of HF (high EQ) cut or boost applied to the effect output (in dB). Range is from -12dB to +12dB with 0dB at top dead centre.
5	lo eq control knob	Adjusts the amount of LF (low EQ) cut or boost applied to the effects output (in dB). Range is from -12dB to +12dB with 0dB at top dead centre.
6	gain control knob	Adjusts the signal level (dB). Range is from -20dB to +20dB, with 0dB at top dead centre.

<i>Item</i>	<i>Control</i>	<i>Function</i>
7	<b>feedback</b> control knob	Adjusts the amount of negative/positive feedback applied to the phaser. Range is from -100% to +100%, with 0% at top dead centre.
8	<b>spin</b> control knob	Adjusts the amount of relative phase of left/right modulation. Range is from 0% to 100%.
9	<b>STAGES</b> button	Selects the number of all pass stages, which sets the number of notches in the frequency response.
10	<b>SWEEP</b> button	Sets the modulation waveform shape.
11	<b>MODE</b> button	Selects the operating mode: single; dual series; dual parallel; linked series; or linked parallel. When linked, modulation of phasers 1 and 2 are linked.
12	<b>ON</b> button	Switching the phaser effect on and off. Illuminates to indicate effect is on.
13	<b>depth</b> control knob	Controls the intensity of the effect by setting the depth of modulation. Range is from 0% to 100%.
14	<b>blend</b> control knob	Adjusts the mix between dry (0%) wet (100%).
15	Mode	Displays the current mode, selected by the <b>MODE</b> switch.
16	<b>Input</b> meters	Two rows of 15 green LEDs — one row each for L (left) and R (right) — comprise the inputs meters.
17	Sweep	Displays the sweep, selected by the <b>SWEEP</b> button.
18	<b>Output</b> meters	Two rows of 15 green LEDs — one row each for L (left) and R (right) — comprise the output meters.
19	Number of all pass stages	Displays the number of all pass stages, selected by the <b>STAGES</b> button.

## Pitch Shifter effect

The Pitch Shifter effect is a sound processing device for changing the pitch of an audio signal without changing its duration.

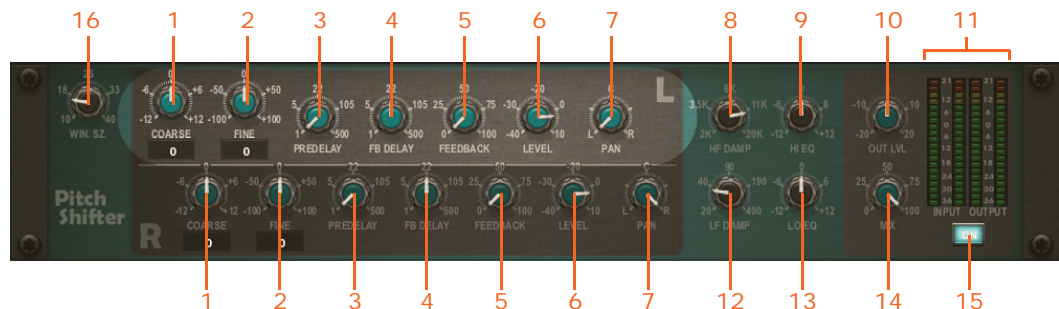

Front panel of the pitch shifter effect

Item	Control	Function
1	<b>COARSE</b> control knob	Adjusts the pitch shifting amount in whole tones. Range is from -12 to +12, with 0 at top dead centre. The numerical value is shown underneath.
2	<b>FINE</b> control knob	Fine tunes the pitch shifting in 1% increments of a whole tone. Range is from -100 to +100, with 0 at top dead centre. The numerical value is shown underneath.
3	<b>PREDELAY</b> control knob	Sets the delay time before the pitch shift. Range is from 1 to 500, with 22 at top dead centre.
4	<b>FB DELAY</b> control knob	Sets the delay time on the feedback loop. Range is from 1 to 500, with 22 at top dead centre.
5	<b>FEEDBACK</b> control knob	Sets the amount of feedback (output fed back to input) in %. For more details, see "Feedback" on page 138. Range is from 0 to 100, with 50 at top dead centre.
6	<b>LEVEL</b> control knob	Sets the output level of the individual channel. Range is from -40 to -10, with -20 at top dead centre.
7	<b>PAN</b> control knob	Adjusts the position of the individual channel signal in the unit's stereo output.
8	<b>HF DAMP</b> control knob	Adjusts the HF attenuation of delay repeats. Range is from 2k to 20k, with 6k at top dead centre.
9	<b>HI EQ</b> control knob	Boosts/attenuates high frequencies. Range is from -12 to +12, with 0 at top dead centre.
10	<b>OUT LVL</b> control knob	Sets the overall output level. Range is from -20 to +20, with 0 at top dead centre.
11	<b>INPUT</b> and <b>OUTPUT</b> meters	Shows the input/output signal levels on dual 20-segment meters (-36dB to +21dB).
12	<b>LF DAMP</b> control knob	Adjusts the LF attenuation of delay repeats. Range is from 20 to 400.
13	<b>LO EQ</b> control knob	Boosts/attenuates low frequencies. Range is from -12 to +12, with 0 at top dead centre.
14	<b>MIX</b> control knob	Controls the balance between dry signal and effect. Range is from 0 to 100, with 50 at top dead centre.

Item	Control	Function
15	ON switch	Switches pitch shifter effect on/off.
16	Win Sz control knob	Sets the window size used by the pitch shift algorithm. High values result in larger latency, but better quality for low frequency or polyphonic audio source. Low values produce low latency and work best on monophonic audio source.

## Feedback

The pitch shifter accepts the input signal and then delays it and plays it back at a different speed, so that its output is delayed and pitch shifted. When this output is fed back into the pitch shifter, further delays and more pitch shifting occur. This can lead to some strange effects, such as feedback.

## SQ1 Dynamics effect

For information on the Klark Teknik Square One Dynamics, refer to its Operator Manual (part number DOC02-SQ1DYNAMIC).



Front panel of the SQ1 dynamics effect

## 3-Band Compressor effect

The 3-Band Compressor effect is for applying different compression profiles to different areas of the audio spectrum.

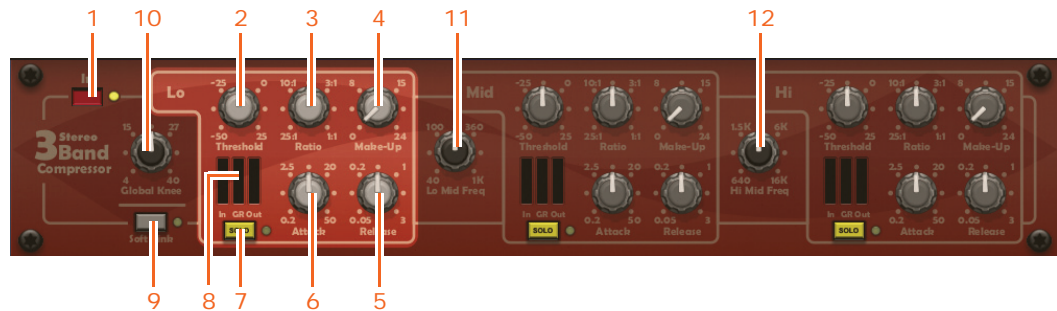

Front panel of the 3-band compressor effect

Item	Control	Function
1	In button	Switches the stereo 3-band compressor in/out. It has an adjacent LED (yellow) for in/out indication.
2	Threshold control knob	This control is in the <b>Lo</b> , <b>Mid</b> and <b>Hi</b> sections, and is used for setting the threshold at which compression begins. Range is from -50dB to +25dB.
3	Ratio control knob	This control is in the <b>Lo</b> , <b>Mid</b> and <b>Hi</b> sections, and is used for setting the compression ratio. Range is from 25:1 to 1:1.
4	Make-Up control knob	This control is in the <b>Lo</b> , <b>Mid</b> and <b>Hi</b> sections, and is used for boosting the output level of the compressed signal. Range is from 0dB to +24dB.
5	Release control knob	This control is in the <b>Lo</b> , <b>Mid</b> and <b>Hi</b> sections, and is used for setting the release time of the compressor. Range is from 0.05sec to 3sec.
6	Attack control knob	This control is in the <b>Lo</b> , <b>Mid</b> and <b>Hi</b> sections, and is used for setting the speed of the onset of compression once the threshold has been exceeded. Range is from 0.2ms to 50ms.
7	SOLO button	This control is in the <b>Lo</b> , <b>Mid</b> and <b>Hi</b> sections, and is used for listening to the compressor's sidechain filter. It has an adjacent LED (yellow) for on/off indication.
8	Three-section meter	This has individual meter elements for input ( <b>In</b> ), gain reduction ( <b>GR</b> ) and output ( <b>Out</b> ) positions of the three bands.
9	Soft Link button	Links the controls with relative offsets. It has an adjacent LED (yellow) for on/off indication.
10	Global Knee control knob	Sets the rate of transition across the threshold. Range is from 4 to 40.
11	Lo Mid Freq control knob	Sets the crossover point between the Lo and Mid compressors. Range is from 40Hz to 1kHz.
12	Hi Mid Freq control knob	Sets the crossover point between the Mid and Hi compressors. Range is from 640Hz to 16kHz.

## Dynamic EQ

The dynamic EQ is a 4-band parametric dynamic equaliser, which is able to provide frequency selective compression or expansion. The dynamic EQ features proportional-Q filters that, when boosting or cutting by small amounts, reduce the bandwidth of the filter compared to the setting at maximum cut/boost. Filter coefficients are calculated at the audio rate to provide a lightning fast attack time, which is essential for transparent operation. Each band features a full-band EQ type that switches out the EQ filter so that the band operates as a non-frequency selective, or 'full-band' compressor/expander. Flexible routing options allow for the following configuration modes:

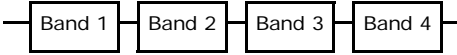
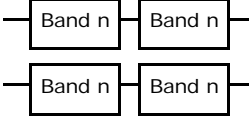
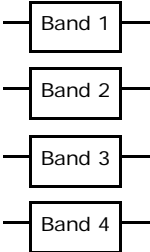
- One chain of stereo 4-band processing. 
- Two chains of stereo 2-band processing. 
- Four chains of stereo single-band processing. 

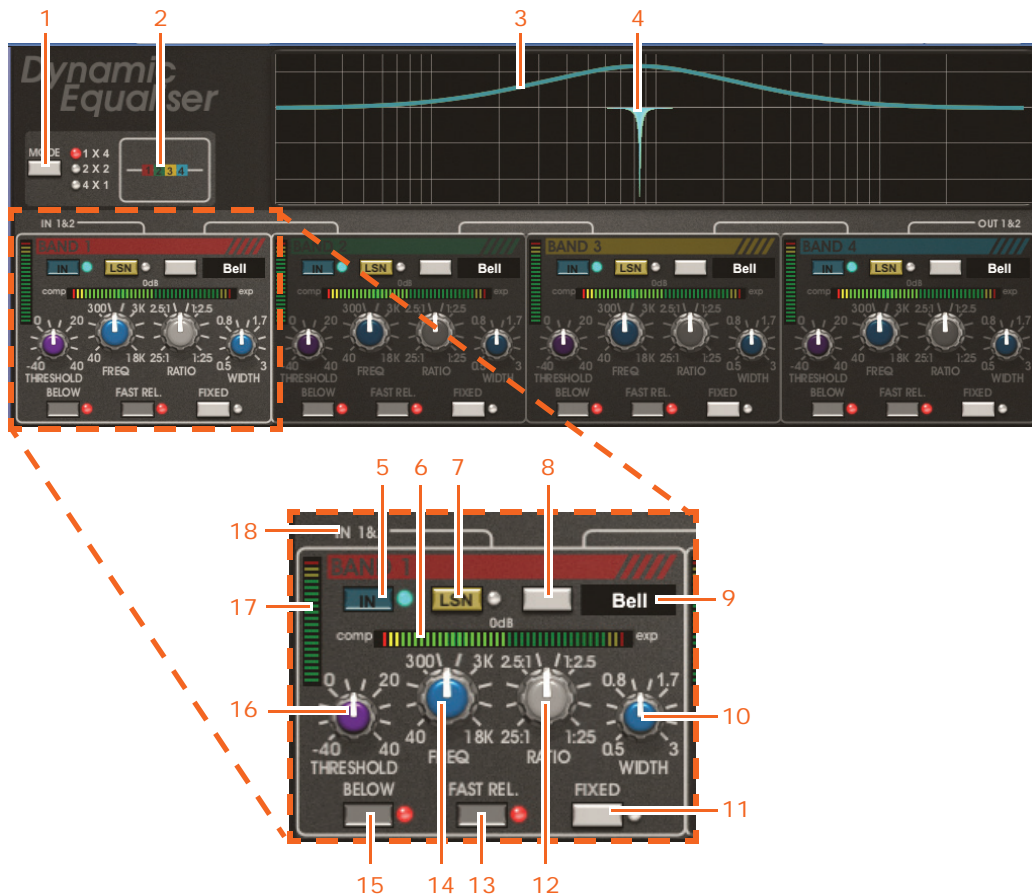

Front panel of the dynamic EQ effect



<i>Item</i>	<i>Element</i>	<i>Function</i>
1	<b>MODE</b> button	Selects the routing configuration. Audio routing paths are illustrated by item 18.
2	Band selection indicator	Shows the selected routing configuration mode.
3	Limit curve	Shows the minimum cut/maximum boost EQ response for the selected band.
4	Dynamic curve	Shows the real time dynamic EQ response curve. This curve will vary between flat (no EQ) and the outer curve (full EQ) depending on the signal level, ratio and threshold settings.
5	<b>IN</b> button and LED indicator	Switches the individual band on/off.
6	<b>comp/exp</b> meter	Shows the current cut/boost of the selected EQ band.
7	<b>LSN</b> button and LED indicator	Sidechain listen button that routes the bandpass filtered sidechain signal to the unit output.
8	EQ type	Selects the type of equaliser (shown in item 9) from <b>Bell</b> , <b>Low Shelf</b> , <b>High Shelf</b> and <b>Full Band</b> .
9	Name field	Shows the currently selected EQ type.
10	<b>WIDTH</b> control knob	Sets the bandwidth of the EQ band and sidechain filter for the selected band.
11	<b>FIXED</b> button and LED indicator	Forces selected band to use a fixed EQ gain, so that when it is enabled it behaves as a static EQ. This is useful for previewing the effect of the EQ curve.
12	<b>RATIO</b> control knob	Sets the ratio of the compression or expansion applied to the selected band. The centre position produces a ratio of 1:1, which will have no effect. As the control is turned anti-clockwise, more compression is applied, up to a ratio of 25:1. If the control is turned clockwise from the centre position, expansion is gradually applied up to the ratio of 1:25.
13	<b>FAST REL.</b> button and LED indicator	Enables fast envelope release setting.
14	<b>FREQ</b> control knob	Sets the centre frequency of the selected EQ band.
15	<b>BELOW</b> button and LED indicator	Sets whether the compressor/expander operates above (off) or below (on) the threshold (see Figure 10 "Transfer characteristics" on page 142).
16	<b>THRESHOLD</b> control knob	Sets the threshold level.
17	Meter	Shows the level of the sidechain signal relative to the threshold setting, that is, it shows the signal level within the frequency region selected by the frequency ( <b>FREQ</b> ) and width ( <b>WIDTH</b> ) controls.
18	Band I/O	Shows the audio routing path between inputs, outputs and the four EQ bands.

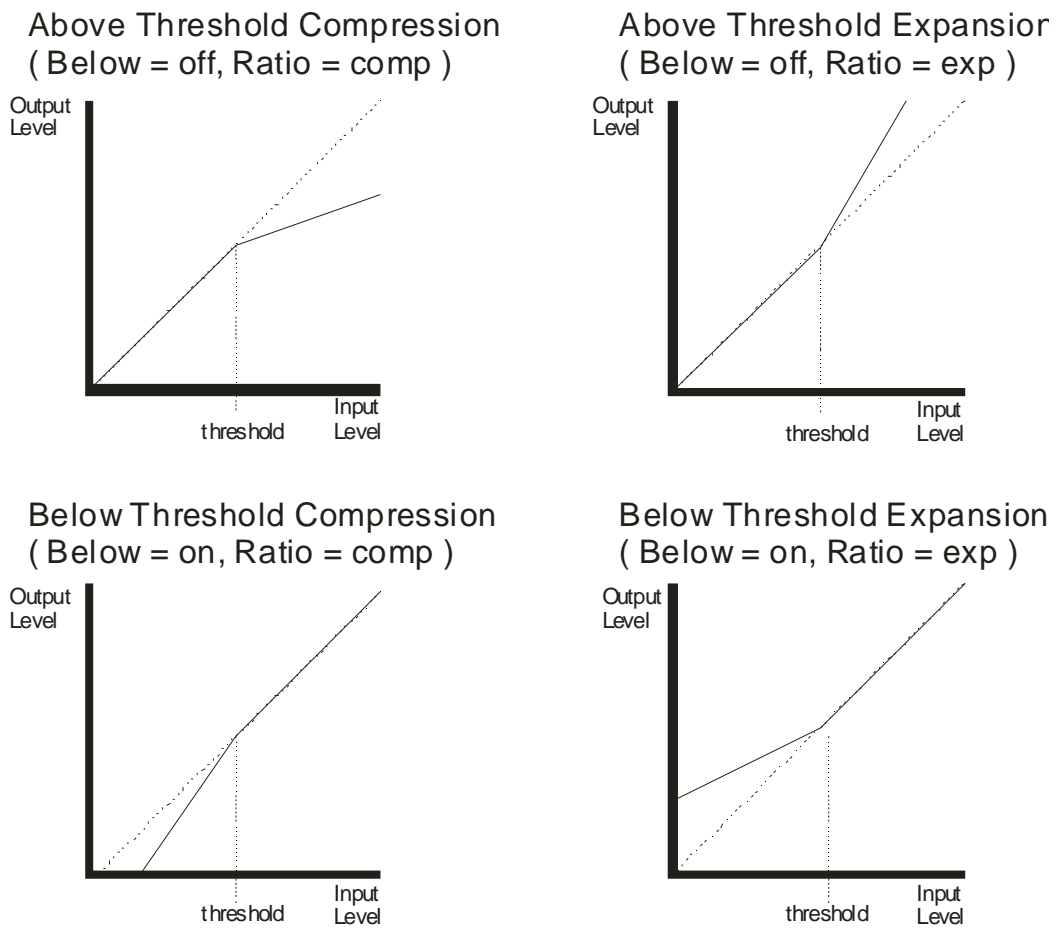

Figure 10: Transfer characteristics



## Chapter 17: Control Groups

PRO2 control groups comprise VCA, POPulation, MCA, auto-mute and talk groups. This chapter explains the functions of each of these groups and shows you the areas on the control surface and GUI that are used for their operation and management.

### VCA and POPulation groups

A VCA/POPulation group can contain any combination of channels. When you select a group via the control surface its channel members are unfolded to the channel faders from right to left. Recalling another VCA/POPulation group deselects the one currently selected.

The GUI provides full support for both groups on the **VCA Groups** screen. This replicates the VCA hardware controls and provides extra functionality. This screen also provides group member management.

For information on group selection and navigation, see Chapter 6 "Working With The PRO2 Control Centre" on page 37 and Chapter 7 "Navigation" on page 43.

For details of VCA/POPulation group configuration and operation, see "Using VCA/POPulation groups" on page 74.

#### >> To select a VCA/POPulation group

Press the LCD select button of the desired group. If you are selecting a VCA group, VCAs must be assigned to the mix faders; if necessary, press the **VCA** button in the **mix bay** section first. If a group is already selected, this will be replaced by the new selection.

Pressing the LCD button a currently selected group will deselect it.

#### >> To open the VCA Groups screen

At the GUI, choose **home** ▶ **Control Groups** ▶ **VCA Groups**.

VCA groups

There are eight VCA groups, which are accessible via the mix fader LCD select buttons when configured for VCA operation.

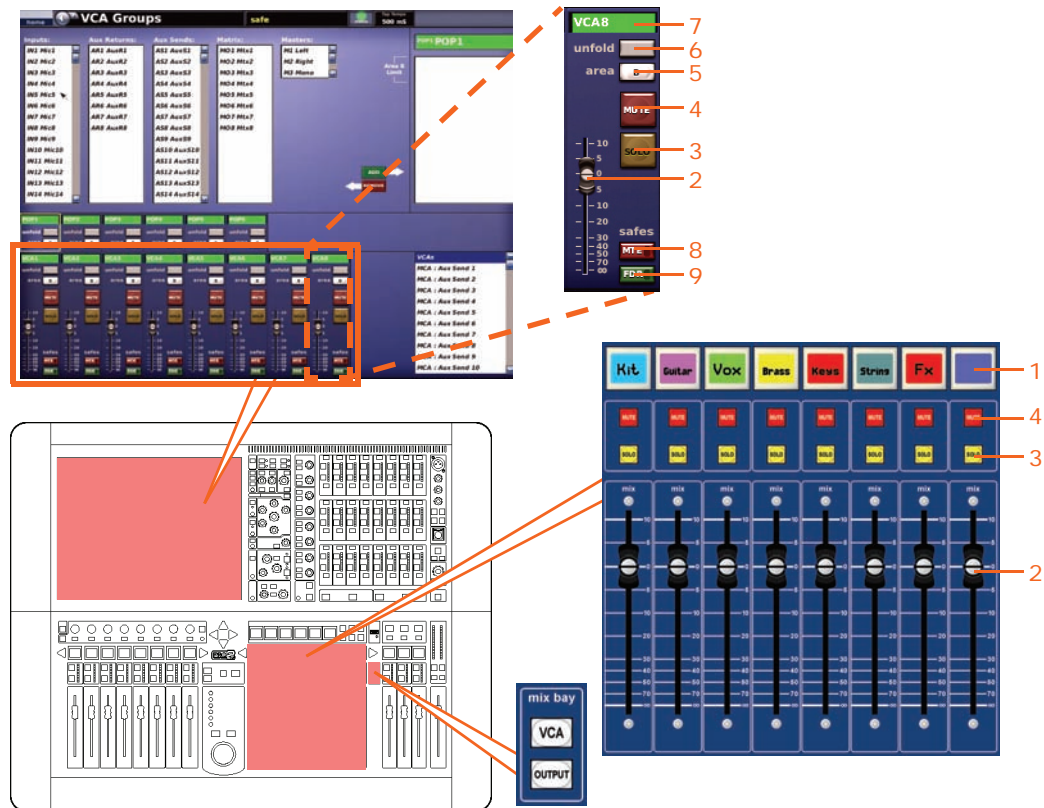

VCA groups on the control surface and GUI

Item	Description
1	LCD select button, selects the VCA group and is also used for group member assignment.
2	VCA group control, adds its level control on top of the local channel fader controls of the group members.
3	<b>SOLO</b> button activates signal routing from all assigned channels to the monitor A section of the control centre. It is used to monitor the VCA master faders by creating a mix on the solo buses, which consists of all input channels and audio mix groups that are assigned to control from corresponding VCA masters.

---

<i>Item</i>	<i>Description</i>
4	<p><b>MUTE</b> switch. This is, technically, not a mute but a fader minus infinity (<math>-\infty</math>) switch that overrides the VCA group master (without moving its physical position). The VCA group mutes can be stored and recalled as part of the scene automation. When on, it mutes all post-fader signals from channels that have been assigned to the VCA group master (regardless of local press, scene mute and SIP mute, which affect only the mute status indicator while channel is muted by VCA). However, it does not update the mute status indicator on the channel (only channel outputs). On removal of the VCA mute, the channel outputs are updated to the current state of the channel mute status indicator.</p> <p>The VCA control group mute has been removed from scene recall and auto-mute action. When mute safe is active all channel mute activation methods, other than by local press, are ignored. De-activating the mute safe condition re-evaluates and applies the current status of auto-mute and SIP mute.</p>
5	<p>Area <b>B</b> button. When this is enabled, the first three group members are assigned to area B on group activation.</p>
6	<p><b>unfold</b> button, assigns the VCA group to the control surface, unfolding the group members to the channel faders.</p>
7	<p>VCA group ID, fixed and user-configured name of group.</p>
8	<p><b>MTE</b> button for selecting mute safe. Integral LED illuminates when the button is switched on.</p>
9	<p><b>FDR</b> button for selecting fader safe. Integral LED illuminates when the button is switched on.</p>

---

## POPulation groups

There are six POPulation groups. Although similar to VGA groups in their methods of group management and selection, they have limited functionality.

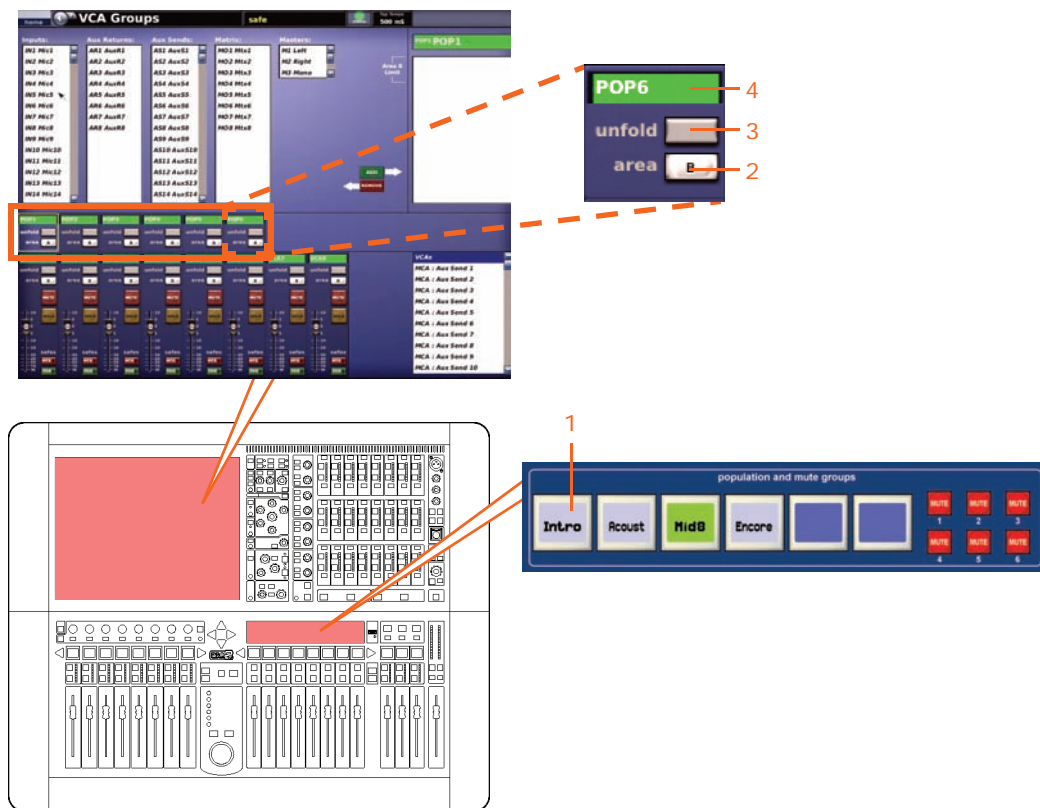

*POPulation groups on the control surface and GUI*

<i>Item</i>	<i>Description</i>
1	LCD select button, selects the VCA group and is also used for group member assignment.
2	Area <b>B</b> button. When this is enabled, the first three group members are assigned to area B on group activation.
3	<b>unfold</b> button, assigns the POPulation group to the control surface, unfolding the group members to the channel faders.
4	POPulation group ID — fixed and user-configured name of group.

## MCA groups

The GUI shows the MCA level associated with the selected mix, as shown in the lower-right corner of the screen. Selecting a VCA shows the VCA level. For information on how to use MCAs, see the PRO2 Live Audio System Quick Start Guide.

## Auto-mute (mute) groups

You can simultaneously mute any channels you want by assigning them to an auto-mute group. You can have up to six auto-mute groups, each one being enabled by its own **MUTE** button in the **population and mute groups** section.

Auto-mute groups are managed via the **Mute Groups** screen of the GUI menu, from where you can assign channels to any of the groups. You can configure the name and background colour of a mute group at the Groups Sheet screen (see “Configuring the groups” on page 150).

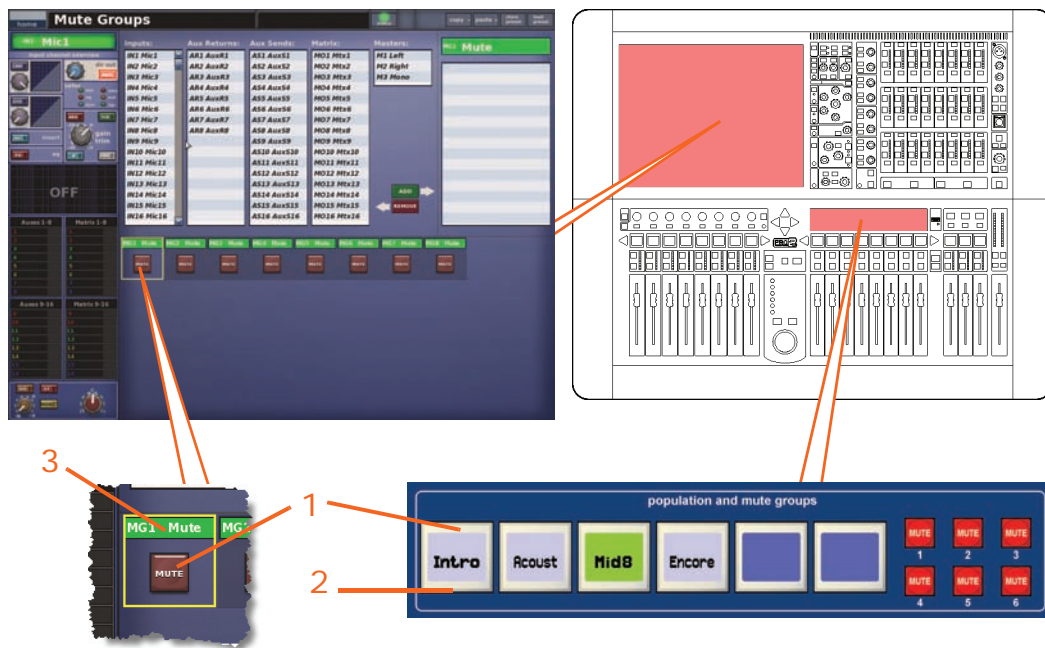

Item	Description
1	<b>MUTE</b> switch, mutes/unmutes all of the assigned channels. Also, the same channel can be assigned to more than one auto-mute group — the channel should be auto-muted while any of the mute groups to which it is assigned are muted.
2	<b>SELECT</b> switch, programs the auto-mute channel assignment. Shows current assignments to mute group and allows them to be changed.
3	Auto-mute group name (default and user-configured).

An auto-mute on can happen because of:

- Activating an assigned auto-mute.
- Assigning an already active auto-mute.
- Recalling a scene that assigns an already active auto-mute.

An auto-mute off can happen because of:

- Deactivating all of the assigned auto-mutes.
- Unassigning all of the active auto-mutes.
- Recalling a scene that de-assigns all of the active auto-mutes.

>> To open the Mute Groups screen

At the GUI, choose **home** ▶ **Control Groups** ▶ **Mute Groups**.

>> To program mute group at the control surface

- 1 In the **auto mute groups** section (master bay), press and hold the **SELECT** button of your chosen auto-mute group.
- 2 Do one of the following:
  - To add inputs to the group, press the LCD select button of each input channel you want in the group. If necessary navigate the input channels you want to the control surface.
  - To add outputs to the group, press the quick access button (bottom of each output fast strip) of each output you want in the group. If necessary navigate the output channels you want to the control surface.

## About the control group screens

The control group screens each have two main areas. The management section at the top allows you to choose the group members, and is common to all control group types. While the bottom section contains the controls and sections specific to each type, which are described later on in this chapter.

### Management section

The group management section of each control group screen has two main panels that, with the aid of the **ADD** and **REMOVE** buttons, let you choose group members.

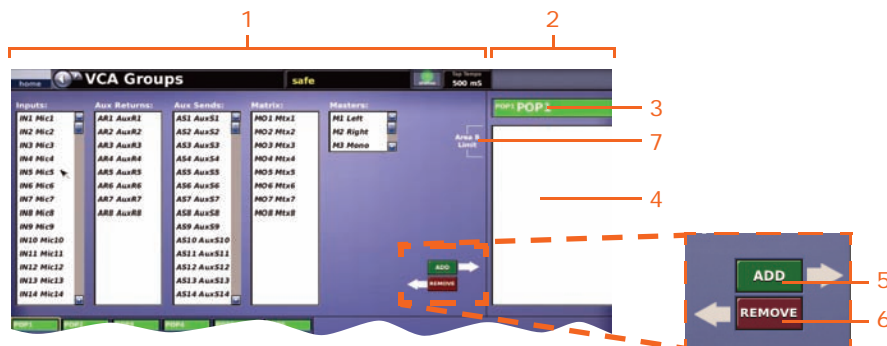

Typical management section of control group screen

<i>Item</i>	<i>Control</i>	<i>Function</i>
1	Group member selection lists	These group type-dependent lists let you choose which inputs, returns, auxes, matrices and masters you want as members in the selected group. If necessary, use the slider on the right of a panel to access all non-members.  You can add more than one member at once by using the Ctrl and Shift keys on the keyboard. Shift will select a range of members and Ctrl will act as an individual toggle.
2	Group member panel	Shows the current group members and lets you
3	Name field	Name of selected group.
4	Group member panel	List of the current members of the selected group.
5	<b>ADD</b> button	Moves the non-members (selected in the group member selection lists) to the group member panel, adding them to the group.
6	<b>REMOVE</b> button	Moves the members (selected in the group member panel) back to their respective group member selection lists, removing them from the group.
7	<b>Area B Limit</b> text	Indicates the group's channel members (up to three) that will be assigned to area B, when configured to do so.

#### >> To program a group at the GUI screen

- 1 Open the screen of the desired control group. For example, if you want to program a VCA group, open the **VCA Groups** screen.
- 2 Click the desired group. For example, **VCA1**.
- 3 Click the channels that you want to add to the group.
- 4 Click **ADD**. The channels will be moved to the group member panel.

If you want to remove any members from the group, click the channels that you want to remove from the group (group member panel). Then, click **REMOVE**. The channels are moved back to their respective lists.

## Configuring the groups

home ▶ *Control Groups* ▶ *Group Sheet*

Similarly to the **Input Sheet** screen, the **Group Sheet** screen lets you change the name and background colour of each group as they appear on the GUI screen and LCD select switch. Additionally, you can change the colour of all the current members of the group to match the group colour by clicking the fill button .

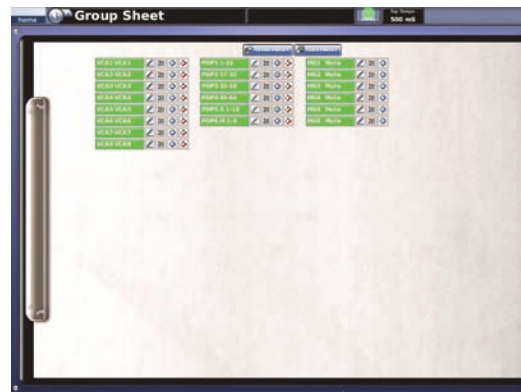

>> To open the **Group Sheet** screen

At the GUI, choose **home ▶ Control Groups ▶ Group Sheet**.



## Chapter 18: Copy And Paste

The PRO2 has a number of copy and paste features that make it easy to copy useful settings to other areas. You can copy and paste the following:

- Detail areas across channels — see “Using copy and paste” on page 87.
- Parameters across GEOs — see “Copying settings between GEOs” on page 126.
- Parameters through scenes — see “Show editor” on page 86.
- Scenes — see “Copying and deleting scenes” on page 169 and “To copy and paste sections to a scene(s)” on page 86.
- Events — see “To save a show or create a new one from the current settings” on page 83.
- Presets — see “To create a new preset library from the current one” on page 201.

For details of the copy and paste, see the Appendices.

### Copying through channels/scenes

The fundamental difference between copying through channels and copying through scenes is that the former is location-based, while the latter can be thought of as being time-based, although the areas (parameters) that are copied across are similar.



## Chapter 19: Assignable Controls

This chapter describes the **assignable controls** section, which has full GUI support and lets you do the following:

- Operate specific detail area controls of the channels currently assigned to the channel faders (see “Operating the channel fader assignments” on page 154).
- Control any rotary on the control surface (see “Controlling a rotary control” on page 155).
- Operate the controls of an internal rack unit (see “Controlling an internal effect/GEQ” on page 157).

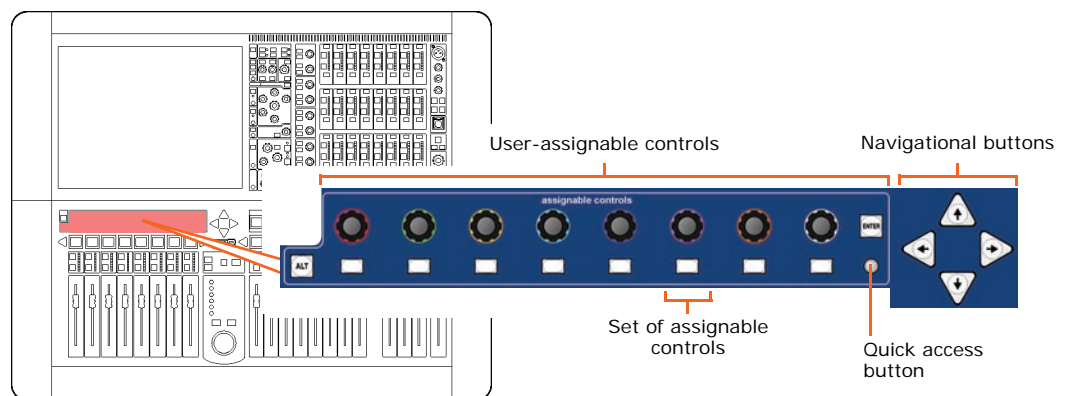

Figure 11: The **assignable controls** section on the control surface

## Operating the channel fader assignments

During normal operation the assignments of the **assignable controls** section follow the cross-hair (see “GUI cross-hair” on page 39) detail area selection. This lets you control a predetermined button and control knob within the selected detail area. Although you can change the button assignment within a detail area (using the **ALT** button) the control knob assignment remains fixed.

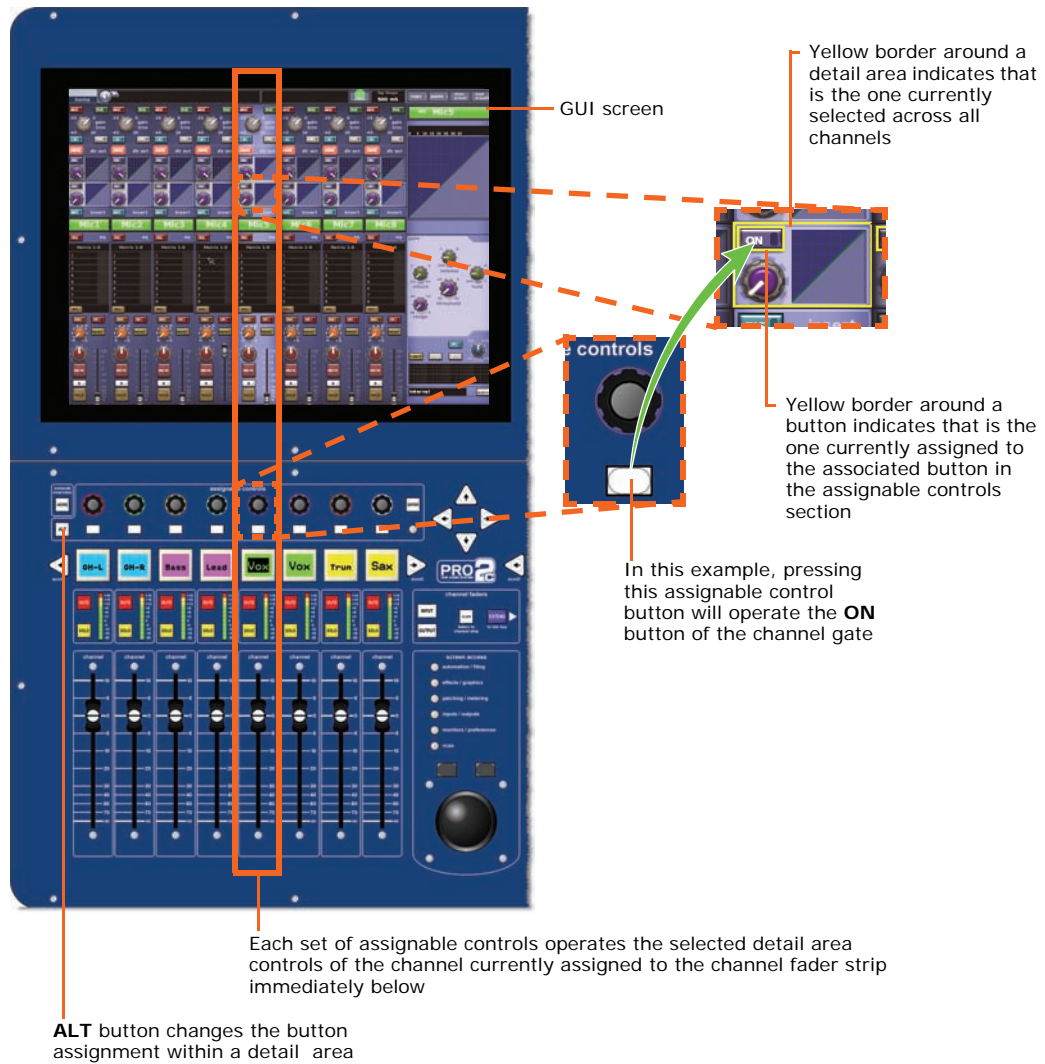

Diagram showing the detail area control assignments of the assignment controls

## Controlling a rotary control

An important function of the PRO2 is one that lets you operate any of the control knob functions on the control surface, such as **gain trim**, compressor/gate **threshold** and **level**, and even any of the internal effects (but not the GEOs), from the **assignable controls** section. This gives you quick access to the controls that are currently the most useful to you. The **Assignable Controls** window lets you assign your desired controls and also shows you the current assignments and status of each one.

In addition, you can assign the 'tap' function of the Delay effect to any pushbutton in the **assignable controls** section. This function — which is also available via the **tap L/tap R** parameters when operating the Delay effect from here — lets you input the delay time manually by tapping the pushbutton instead of choosing a value (see "To manually set the tap time of an effect" on page 156).



Assignable Controls window

Item	Element	Function
1	Name field	Channel name, with background colour to match the default/user-defined channel colour.
2	Control knobs	User-assigned controls.
3	Button	Collapses the control selection lists (item 5).
4	Button	Assign/unassign button.
5	Control selection lists	These offer you all the available options from which to choose your rotary control assignment.
6	Option list	Available control options for the selected channel/effect.
7	Option list	Available channels/effects for the selected channel type/effect.
8	Option list	Available channel types/effect. The options are: <b>Unassigned</b> ; <b>Inputs</b> ; <b>Aux Sends</b> ; <b>Matrix</b> ; <b>Aux Returns</b> ; <b>Masters</b> ; and <b>Effects</b> .

### >> To open the Assignable Controls window

Press the quick access button in the **assignable controls** section (see “The assignable controls section on the control surface” on page 153). In the example shown right no controls have been assigned.

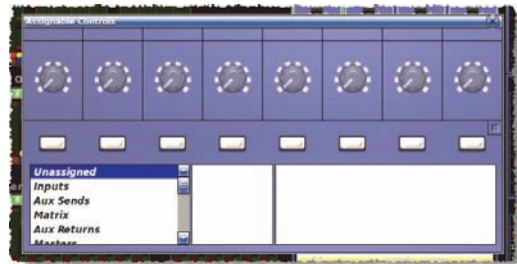

### >> To assign a control to a set of assignable controls

Open the **Assignable Controls** window and select the desired control using the three panels at the bottom of the window (see “About the assignable controls panel on the GUI” on page 157). For example, choose the compressor ratio control of input channel 34. Then click one of the overlying assignment buttons (as shown right).

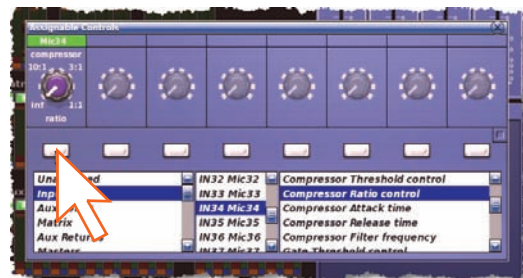

### >> To unassign a control

- 1 In the **Assignable Controls** window on the GUI, click **Unassigned** in the far left panel (bottom of window).
- 2 Click the desired assignment button.

### >> To manually set the tap time of an effect

- 1 Assign the desired effect's delay time parameter to the **assignable controls** section. (Choose **Effects** in the left panel and then the desired channel and delay time parameter from the other panels.)
- 2 Tap the assign/unassign button of the assigned control (just as you would the **Tap** button of the effect) to achieve the desired tap time.

The PRO2 measures the interval between taps. It uses the most recent taps to calculate the average tap time, which is constantly updated according to each subsequent tap. This value is displayed on the effect's front panel in the appropriate **Range** field and is also indicated by the control knob immediately left.



## Controlling an internal effect/GEQ

As the internal effects and GEQs of the PRO2 are primarily GUI-only features, control surface support is provided by the **assignable controls** section, which lets you operate their parameters using physical controls.

With an internal rack unit selected on the GUI, a specific set of its parameter controls will be automatically assigned to the **assignable controls** section. To encompass all of the rack unit's parameter controls they are bundled into predetermined sets — known as 'pages' for effects and 'groups' for GEQs — which are navigated using the arrow buttons (control surface or GUI).

### About the assignable controls panel on the GUI

The **assignable controls** panel is displayed at the bottom of the effect/GEQ window. In addition to replicating the **assignable controls** section on the control surface, it displays additional information, such as button and control knob assignments, current 'page' number, etc.



The following diagram explains the elements of the **assignable controls** panel. It uses the one for the effects as an example, but this also applies to the GEQs.



Item	Description
------	-------------

- |   |  |
|---|--|
| 1 | For the effects only, this shows which 'page' of parameters is currently assigned and is in the format [page number]/[total number of pages]. For example, the diagram above is displaying page 1 of a total of 2 pages. |
| 2 | Single set of controls (button and control knob).  |
| 3 | Control button.  |



Item	Description
4	<b>Effects only:</b> Description of the effect's button currently assigned to the button.  <b>GEQ only:</b> Will show either the text "zoom n" (where n is number from 1 to 8) or "overview" to indicate which display you are in, that is, overview or zoom, respectively.
5	Navigation buttons, which replicate the arrow buttons to the right of the assignable controls section on the control surface (see "Rack and unit control navigation" on page 158).
6	Parameter description of the overlying control knob's assignment.
7	Control knob. Includes gradations and dimensions applicable to the assigned parameter.
8	When a control is unassigned, the assignable controls section displays it as a 'ghost' image. (This also applies to the buttons.)

### Rack and unit control navigation

To navigate the rack and unit controls, use the four navigational buttons (see "The assignable controls section on the control surface" on page 153) to the right of the **assignable controls** panel on the control surface, which are replicated on the GUI.

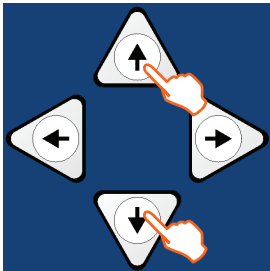
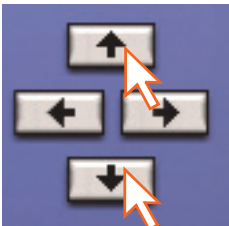
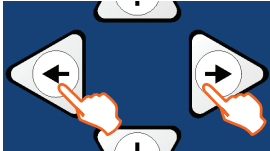
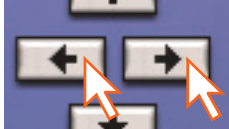
Operating on the control surface or GUI	Does this
 or 	At the <b>Effects</b> or <b>Graphic EQs</b> screen, scrolls up/down through the units in the rack(s), even with the unit window open. Scrolling finishes at the first and last units.
 or 	At the <b>Effects</b> screen, scrolls left/right to predetermined control parameters of the selected effect, even with the unit window open (see Figure 12 "Changing the effect parameter assignments" on page 159). However, the function of these buttons on the <b>Graphic EQs</b> screen is more extensive (see "Controlling a GEQ" on page 159).



*Don't forget that you can operate the selected effect or GEQ in their respective rack unit view (for example, the **Effects** screen shown right) via the control surface or GUI.*





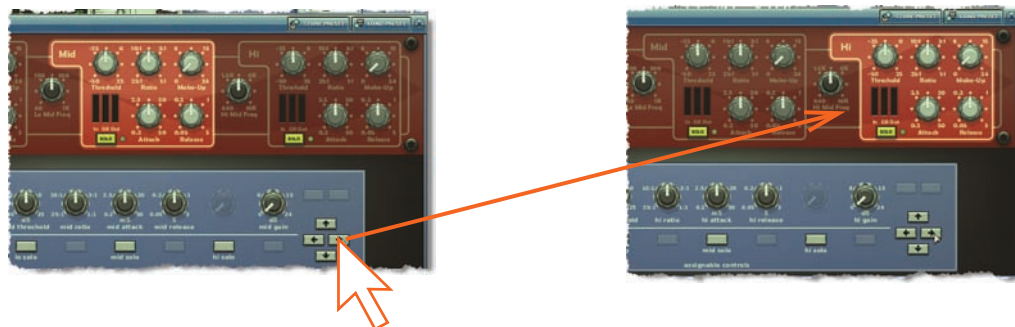

Figure 12: Changing the effect parameter assignments

## Controlling a GEQ

You can use the **assignable controls** section to adjust the faders and controls of an internal GEQ, such as the high/low pass filters, notch filters, slope, etc. To accommodate all of the faders there are, effectively, two levels of display, known as "overview" and "zoom". The overview display appears when you open the window of the GEQ, and lets you adjust a group of GEQ faders simultaneously by the same amount.

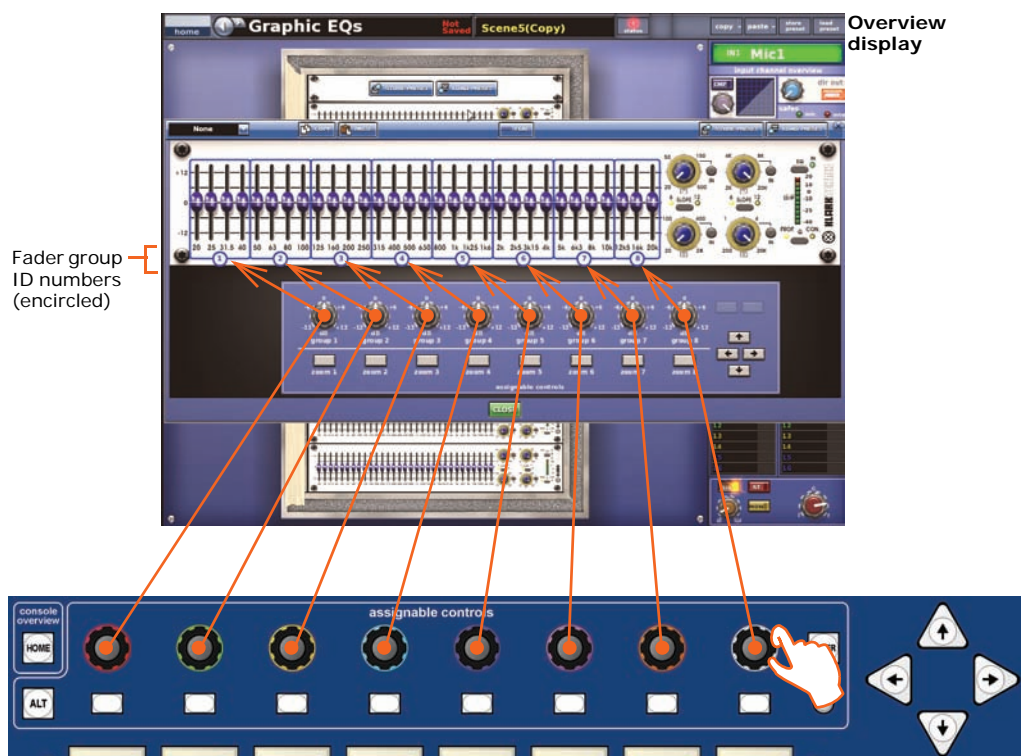

Figure 13: Fader group control knob assignments in the overview display of the **Graphic EQs** screen

In the zoom display, each of the assignable control buttons 'zooms in' on a specific group of faders. Each fader is assigned its own control knob in the assignable controls section, so that it can be operated individually. The right navigation arrow button opens the GEQs control panel (far right).

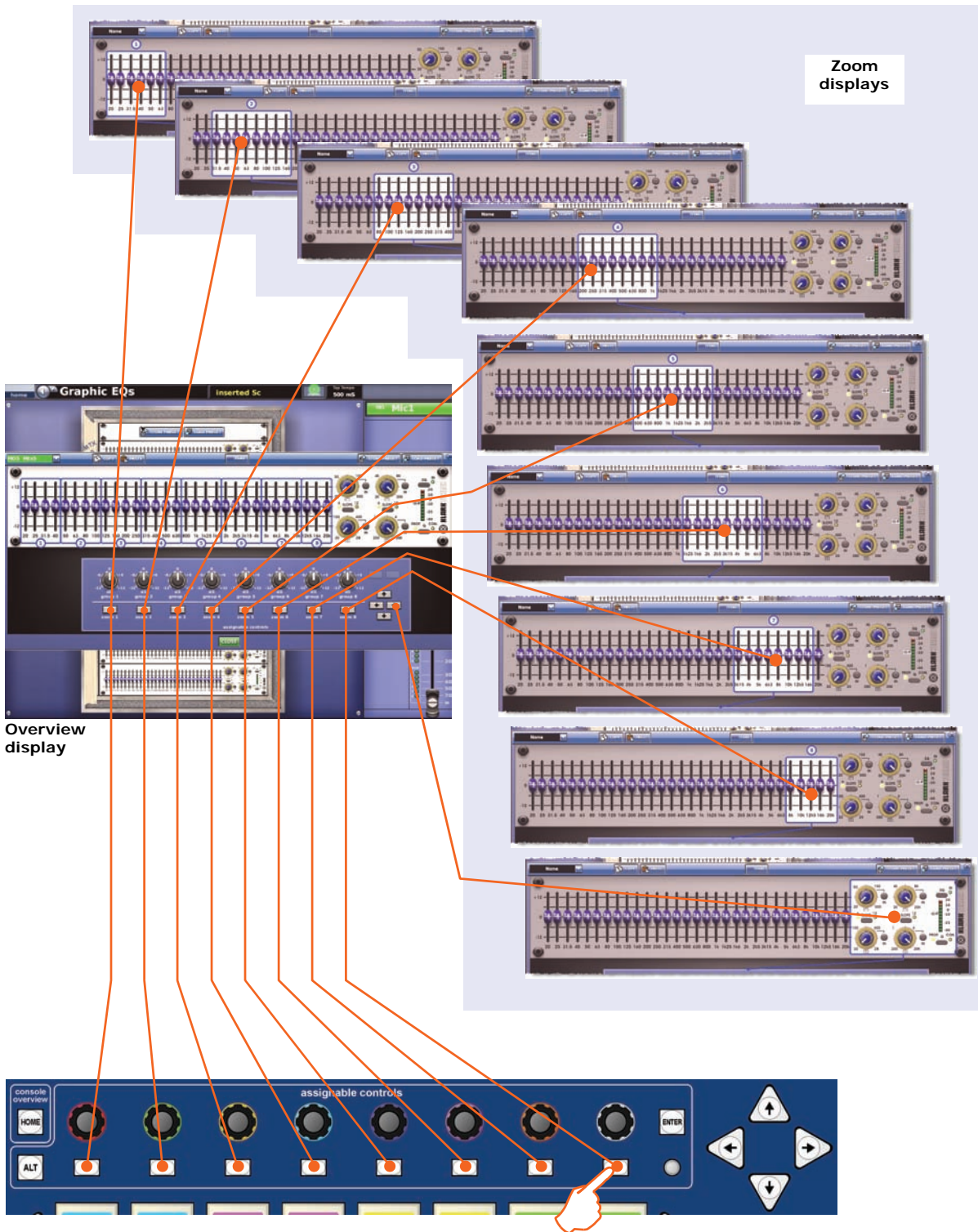

Figure 14: I zone LCD button assignments in the overview display

## Chapter 20: Scenes And Shows (Automation)

This chapter shows you how to use scenes and shows, which are part of PRO2 automation.

### About automation

Automation is predominantly a GUI-only function that allows complex editing of scenes and the creation of show files via the GUI menu. The control surface provides limited control via the **automation** section, which facilitates fast store/recall operation during show time and rehearsals.

The automation system of the PRO2 can store and recall up to 1000 scenes, each one being a snapshot of the control centre's settings at the instant the scene was created. By recalling scenes, users can — with certain exceptions — restore the control centre to the state that existed at that time the scenes were stored. This makes it ideal for multi-act tours by providing quick and accurate access of settings for the band with a minimum of sound check time, as well as for theatre productions, where each act requires reconfiguration of audio I/O.

All of the scenes for a show are contained within a show file. Show files are stored in the PRO2, so that they can be loaded when required, and they can also be transferred to/from external USB storage devices.

Shows can contain events. An event may trigger, for example, the sending of a MIDI message, a GPIO output voltage, or action an internal function. They can also be used for crossfades between scenes.

For theatre applications, channel settings can be recalled (across all scenes) from the user library (see Chapter 24 "User Libraries (Presets)" on page 199) so that one generic show can cope with different performers on a night-by-night basis.

You can copy certain parameters through scenes by using the **Show Editor** screen. For more information on the **Show Editor** screen and for details on how to use it for copying and pasting throughout scenes, see "Show editor" on page 86. For details of the parameters that can be copied through the scenes, see Appendix I "Parameters Affected By Copy And Paste" on page 431.

Throughout this chapter, wherever scenes are mentioned this also applies to point scenes, unless otherwise stated.

## Automation controls

Although automation is supported on the master bay control surface by the **automation** section, most of the functionality is accessed via the GUI. The **Automation** screen allows editing of scenes, show files and events, and provides access to the scope editing screens. Additionally, the GUI has a **Files** screen for show file management and transfer.

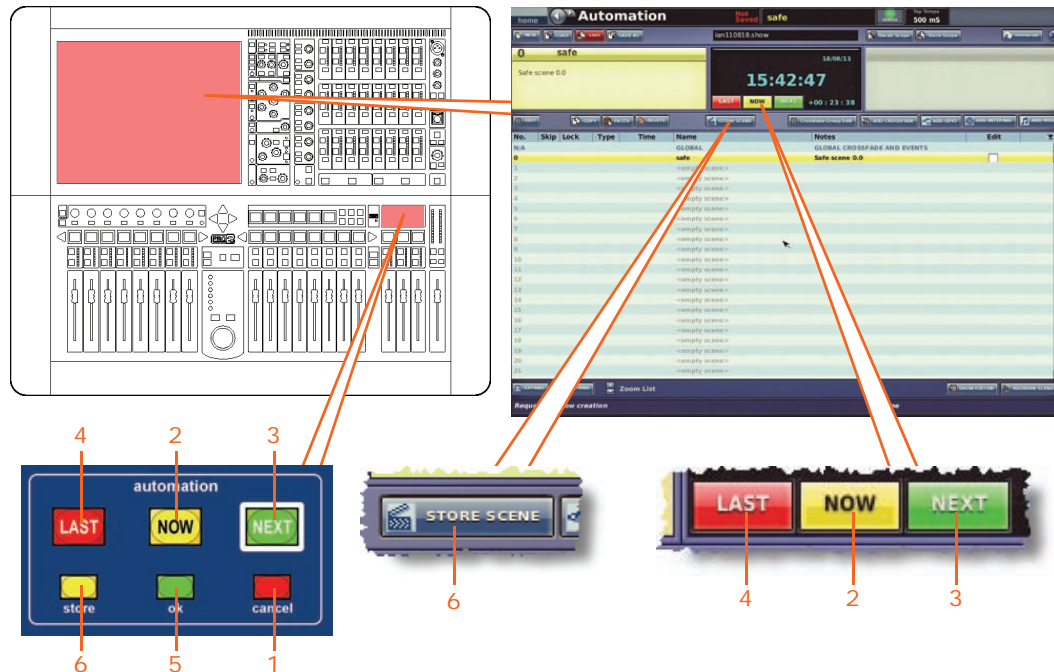

Automation controls on the control surface and GUI

Item	Control	Function
1	Red <b>cancel</b> button	Cancels a store operation and closes the <b>Store</b> window (illuminates to prompt when this button is active).
2	Yellow <b>NOW</b> button	Recalls the currently highlighted scene in the cue list, clearing any unsaved adjustments.
3	Green <b>NEXT</b> LCD button	Recalls the next scene/point scene (highlighted in green) in the cue list.
4	Red <b>LAST</b> button	Recalls the previous scene (highlighted in red) in the cue list.
5	Green <b>ok</b> button	Confirms an action (illuminates to prompt when this is necessary).
6	<b>store/[STORE SCENE]</b> button	Opens the <b>Store Scene</b> window (see "To create a new scene using the current settings" on page 59) and lets you store the current settings to the currently selected scene.



## Automation screen

The **Automation** screen (shown right) contains information on the following:

- Scenes — see “Scenes” on page 164.
- Shows — see “Show files” on page 172.
- Scope — see Chapter 21 “Scope (Automation)” on page 177.
- Events — see Chapter 23 “Crossfades (Automation)” on page 191.

For details of how to open the Automation screen, see “To open the Automation screen” on page 82.

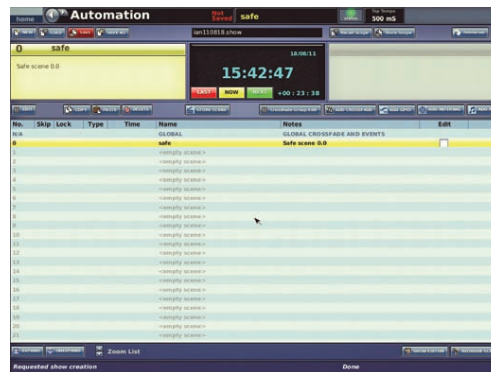

## Using the right-click menu

You can access some of the functions of the function buttons and also additional functions by right-clicking the desired scene. This opens a menu that has the following options:

- **Edit**: Opens the **Edit Scene Properties** window.
- **Add**: Opens a submenu with the following options:
  - **Overwrite Scene**: Overstores the scene with any changes made. For example, if you are working on scene 2, and you have made changes to it, right-click on scene 3 and then select **Add > Overwrite Scene**, and scene 3 will be overstored with the changes made to scene 2.
  - **Insert Scene**: Inserts the scene you have just copied immediately before this one.
  - **Midi Event**: Creates a MIDI event in the scene.
  - **Internal Event**: Creates an internal event in the scene.
  - **GPIO Event**: Creates a GPIO event in the scene.
  - **Crossfade Event**: Creates a crossfade event in the scene.
- **Delete**: Deletes the selected scene (see “Copying and deleting scenes” on page 169).
- **Copy**: Copies the selected scene (see “Copying and deleting scenes” on page 169).
- **Paste**: Pastes the scene you have just copied.
- **Expand**: Expands the scene/point scene (see “To expand a scene/point scene” on page 167).
- **Un-Expand**: Closes the point scenes of the scene/point scene (see “To expand a scene/point scene” on page 167).
- **Multi-Edit**: Opens a submenu with the following options:
  - **Set List**: Opens the **Set List** window.
  - **Show Editor**: Opens the **Show Editor** window.
- **Invert Selection**: Any scenes that have been ‘checked’ (that is, their check box in the **Edit** column contains an “X”) become unchecked, and vice versa.

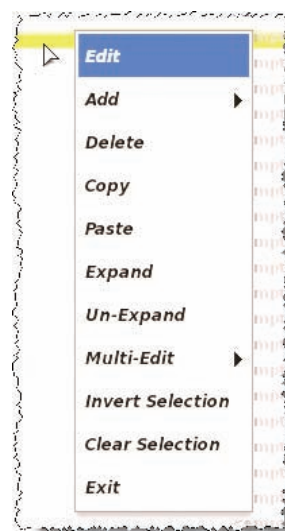

- **Clear Selection:** Unchecks any scenes that have been checked.
- **Exit:** Closes the right-click menu.

## Scenes

The scene management areas of the **Automation** screen are intended for fast operation during show time and rehearsals. They let you edit, copy, delete, store and recall scenes, and can be broadly subdivided into the following areas.

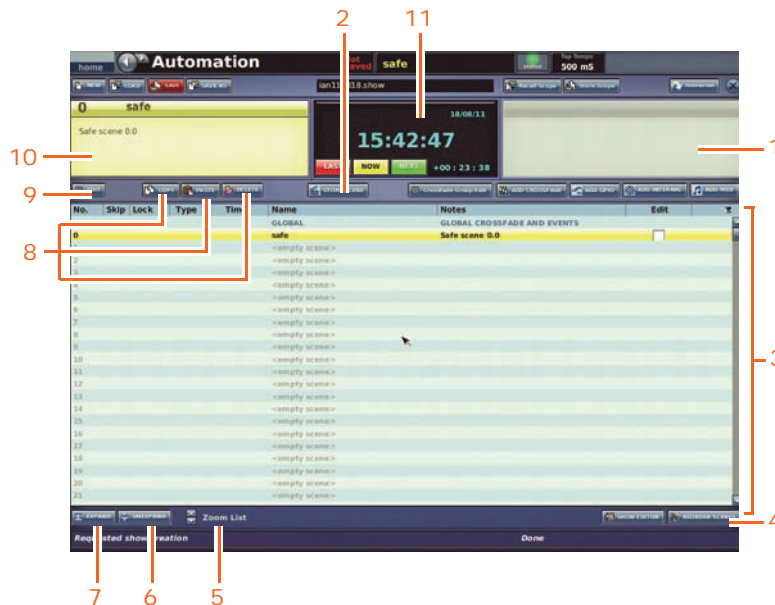

Scene-related elements of the **Automation** screen

Item	Element	Description
1	Scene panel	Contains scene number, title and notes pertaining to the 'next' scene.
2	<b>STORE SCENE</b> button	See "Automation controls" on page 162.
3	Scene cue list	See "Scene cue list" on page 166.
4	<b>REORDER SCENES</b> button	See "Changing the order of the scenes" on page 170.
5	<b>Zoom List</b> spin buttons	See "Using zoom" on page 171.
6	<b>UNEXPAND</b> button	See "To close the point scenes of a scene/point scene" on page 167.
7	<b>EXPAND</b> button	See "To expand a scene/point scene" on page 167.
8	<b>DELETE, PASTE</b> and <b>COPY</b> buttons	See "Copying and deleting scenes" on page 169.
9	<b>EDIT</b> button	See "Editing scene properties" on page 168.
10	Scene panel	Contains scene number, title and notes pertaining to the 'now' scene.
11	Show information panel	See "Date and time" on page 166 and "Automation controls" on page 162.

For details of how to recall a scene and create a new scene from the currently selected one, see “Managing the scenes” on page 84.

## Scene contents

A scene contains all of the control centre settings that existed at the point of creation, except:

- Anything that is explicitly taken out of store or recall using the automation scope controls.
- All solo, monitor and comms section controls.
- All surface selection or navigational control settings.

Additionally, each scene can contain:

- Scene information, including name and notes.
- Events — MIDI, GPIO, internal and crossfades.

## Point scenes

For every scene there are 10 point scenes available, and each point scene has another 10 point scenes. Point scenes are the same as scenes. They allow each scene to be divided into smaller sections.

## Numbering and navigation

As scenes need to be recalled in sequence, each scene requires a sequential number. So, although there is a maximum of 1000 scenes, the range of scene numbers is much greater to allow for gaps to be left for adding scenes without having to renumber the subsequent scenes — a major requirement in scripted shows. To facilitate this, each scene has an associated four-digit, two-decimal place scene number, giving a possible 99 point scenes per main scene. The scene number locates the scene in the sequence of stored scenes and is the basis of scene navigation.

## Initial snapshot scene (scene 0)

All scene numbers are available for storing scenes except scene 0, which is called the “safe” scene. This scene is the control centre’s initial snapshot scene, which cannot be overwritten by the user. It is the only snapshot present when there is no show loaded.

When recalled, it sets the control centre — regardless of scope settings (unless hardware safes are in place) — to a safe state in which it is not passing any audio.

The settings include:

- All mutes off.
- Gains are set to 0dB.
- All levels are at minus infinity ( $-\infty$ ) dB.
- All faders are at minus infinity ( $-\infty$ ) dB — except VCA faders, which remain at 0dB.

## Date and time

The current date and time, and the duration of the current scene are displayed towards the top of the **Automation** screen.



## Scene cue list

The scene cue list provides you with an overview of the show. It tells you at a glance where you are in the performance and provides scene information, such as scene number and title, some of which are editable. Other features allow you to alter settings, 'skip' scenes and edit scene properties.

The scene cue list provides you with an overview of the show. It tells you at a glance where you are in the performance and provides scene information, such as scene number and title. Other features let you alter settings, 'skip' scenes, edit scene properties and choose what to leave out of the cue list.

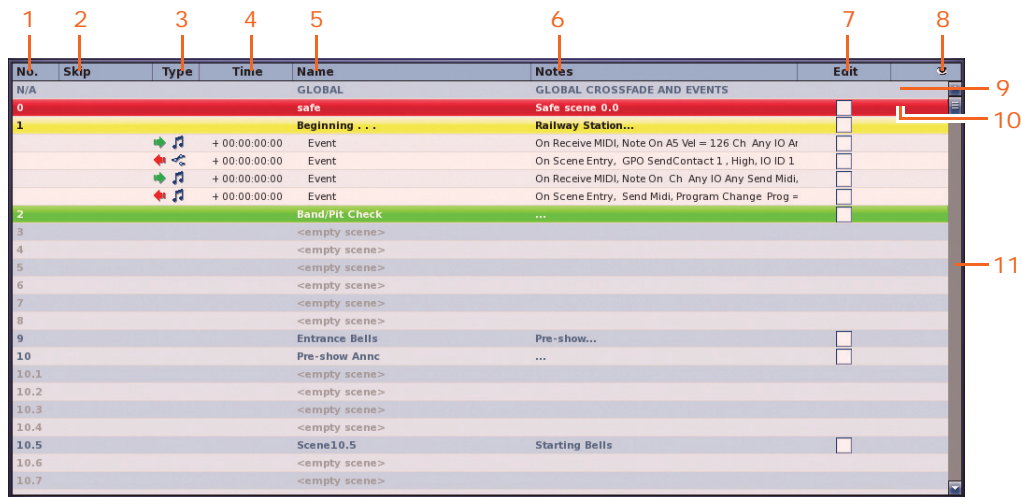

Elements of the scene cue list

Item	Element	Description
1	<b>No.</b> column	Number column shows the scene number and point scene number.
2	<b>Skip</b> column	Skip column. When you see a skip arrow  in this column it means that this scene will be missed out during a rehearsal. For example, during rehearsal you may need skip scene 3 by going straight from scene 2 to scene 4 (auto status). Also, indicates scene selection when it contains an event (yellow circle).
3	<b>Type</b> column	Shows the type of events and whether they are incoming or outgoing.
4	<b>Time</b> column	Displays the time before an event is triggered. A blue countdown time bar shows the time remaining.
5	<b>Name</b> column	Title of scene/point scene or name of event.
6	<b>Notes</b> column	Scene notes.



<i>Item</i>	<i>Element</i>	<i>Description</i>
7	<b>Edit</b> column	Contains a tick box per scene/event, which is used for selection purposes when reordering scenes, see “Changing the order of the scenes” on page 170.
8	Eye symbol 	Opens the <b>Show</b> window (see “Configuring the scene cue list view” on page 168).
9	<b>GLOBAL</b> scene	See “Additional control — managing events” on page 60.
10	<b>safe</b> scene	See “Initial snapshot scene (scene 0)” on page 165.
11	Scroll bar	Lets you scroll to the other scenes.

### >> To select a scene/point scene

The ‘now’ scene is the currently selected scene (highlighted in yellow).

Do one of the following:

- At the GUI, click the scene/point scene in the **Automation** screen.
- At the GUI, click the **LAST/NOW/NEXT** button in the **Automation** screen as necessary.
- In the **automation** section (control surface), press the **last/now/next** buttons as necessary.



*When recalling a scene, you can avoid replacing the current settings by using scope masks, see Chapter 21 “Scope (Automation)” on page 177.*

### >> To expand a scene/point scene

Select the scene/point scene and do one of the following:

- Click **EXPAND**.
- Right-click the scene to open the right-click menu. Then, choose **Expand**.

### >> To close the point scenes of a scene/point scene

Select the scene/point scene and do one of the following:

- Click **UNEXPAND**.
- Right-click the scene to open the right-click menu. Then, choose **Un-Expand**.

### Configuring the scene cue list view

You can exclude any of the following elements from the scene cue list (see “Scene cue list” on page 166), which is done via the **Show** window (shown right):

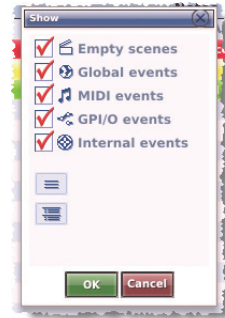

- **Empty scenes**
- **Global events**
- **MIDI events**
- **GPI/O events**
- **Internal events**

>> **To configure the scene cue list view**

- 1 Click the eye symbol  (right of the cue list title bar) to open the **Show** window.
- 2 In the **Show** window, select (tick) the desired option(s).
- 3 Click **OK**.

### Editing scene properties

You can change the name of a scene, add/edit its notes (also editable in the **Store** window when storing a scene), choose to skip the scene during a rehearsal and choose to lock pending events and scene crossfades. This is all done via the **Edit Scene Properties** window (shown right).

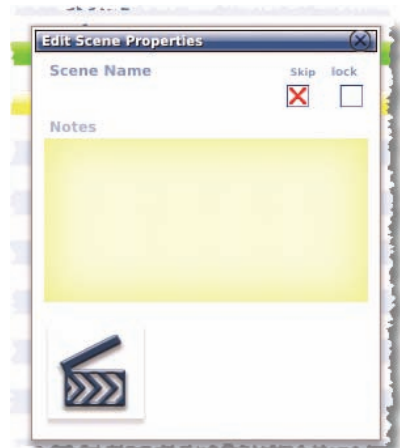

The flexibility of the automation system means that complex schemes of events can lead to situations where the console is operating in potentially strange ways. For example, it is possible that an event could be set to an unintentionally long delay time or a jump event creates an endless loop. The lock option, when selected, provides a 'break' in this loop.



The **Scene Name** and **Notes** sections are edited just as you would any other text field.

>> **To open the Edit Scene Properties window**



Do one of the following:

- Select the scene and then click **EDIT**.
- Right-click on the scene and then choose **Edit** from the right-click menu.

>> **To skip a scene during rehearsal**

Open the **Edit Scene Properties** window of the desired scene, and then click the **Skip** box to place a red cross  inside it. After you close the window, a skip arrow symbol  will appear in the scene's **Skip** column.

>> **To lock a scene's pending events or crossfades**

Open the **Edit Scene Properties** window of the desired scene, and then click the **lock** box to place a red cross  inside it. After you close the window, a lock symbol  will appear in the scene's **Lock** column.

## Adding a new scene

You can add a new scene anywhere in the cue list. The new scene can be inserted in the cue list or you can overwrite an existing scene, which replaces it with the new one.

### >> To insert a new scene

- 1 Right-click the scene before which you want to insert the new one.
- 2 From the right-click menu, choose **Insert Scene**.

### >> To overwrite an existing scene with a new one

- 1 Right-click the scene you want to overwrite.
- 2 From the right-click menu, choose **Overwrite Scene**.

**Note:** If you are creating the first scene, use **STORE SCENE** (see "To create a new scene using the current settings" on page 59).

## Copying and deleting scenes

You can copy and delete single scenes/point scenes from the cue list.

### >> To copy a scene

- 1 Do one of the following:
  - Select the scene you want and click **COPY**.
  - Right-click the scene and then choose **Copy** from the right-click menu.
- 2 In the cue list, select the scene/point scene before which you want to paste the copied scene. Then, click **PASTE**.

### >> To delete a scene

- 1 Do one of the following:
  - Select the scene and then click **DELETE**.
  - Right-click on the scene and then choose **Delete** from the right-click menu.
- 2 In the message window (shown right), click **OK**.

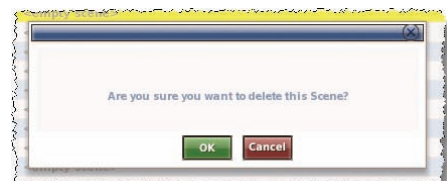

## Changing the order of the scenes

You can change the order of the scenes in the cue list. This is done using **REORDER SCENES** button. You can reorder as many scenes as you want by selecting them in the order you want them to appear in the reordered list.

### >> To reorder the scenes

- 1 In the Automation screen, click **REORDER SCENES**. The grey double arrowhead symbol  will appear in each box in the **Edit** column.
- 2 In the cue list, click the box of the first scene you to reorder (as shown right). A "1" will appear in the **Edit** column, signifying that it will be the first of the reordered scenes, and the scenes will be reordered from this point on in the cue list.
- 3 Repeat for the next scene you want to reorder. This will be labelled "2" in the **Edit** column.
- 4 Repeat for the remaining scenes/point scenes.
- 5 Click **REORDER SCENES**. The message window (shown right) will open.
- 6 Click **OK**.

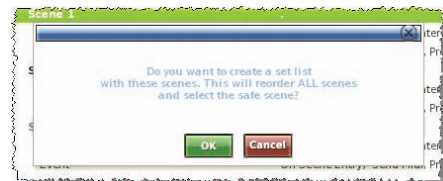
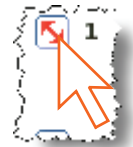

## Overriding store scope

You can choose to ignore the parameters selected at the **Store Scope** screen (Chapter 21 "Scope (Automation)" on page 177), so that these 'safed' parameters *will* be stored in the scene. This is selectable as a global option (for all scenes) in the **Preferences** screen and also on a per scene basis in the **Store Scene** window.

**Note:** *This feature does not affect scene recall.*

### >> To override the safe parameters (selected in store scope) for a single scene

Open the **Store Scene** window (see "To create a new scene using the current settings" on page 84) and select the **Overwrite Safe parameters?** option.

### >> To override the safed parameters (selected in store scope) for every scene

At a GUI screen, choose **home ▶ Preferences ▶ General** and then click the **User** tab to open the **Preferences User** screen. Then, select the **Overwrite "Safe" parameters** option in the **On Scene Store** section.

## Using patching in automation

- ! The **Automate Patching** option switches on per-scene automatic routing, and must be used with caution. To alert you to the drastic consequences of using this option, a **WARNING** window appears.

You can change the patching of certain sources and destinations on a per-scene basis. For example, you have an input channel's compressor side chain patched from one source in one scene and from a different source in another scene.

For details of the parameters that can be patched per scene, see Appendix G "Parameters Affected By Automate Patching" on page 381.

### >> To use patching in automation

At a GUI screen, choose **home ▶ Preferences ▶ General** to open the **Preferences** screen, and select the **Automate Patching** option in the **Configuration Preferences** section.

## Using zoom

You can enlarge the cue list to zoom in on certain scenes or make the scenes in the cue list smaller so that you can view more scenes simultaneously. This is done using the **Zoom List** spin buttons.



### >> To enlarge the scene view (zoom in)

In the **Automation** screen, click the up (top) **Zoom List** spin button. The diagram right shows a typical **Automation** screen at maximum zoom.

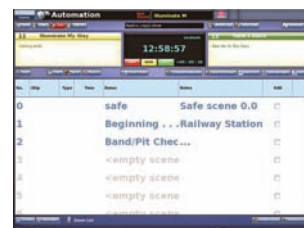

### >> To reduce the scene view (zoom out)

In the **Automation** screen, click the down (bottom) **Zoom List** spin button. The diagram right shows a typical **Automation** screen at minimum zoom.



## Show files

Show files are only handled via the GUI, using the **Automation** and **Files** screens of the GUI menu.

### Managing show files

The **Automation** screen lets you create new shows, load existing ones and update the current show file with the latest settings.

For details of how to use the show function buttons to create a new show, save a show, create a new show from the current settings and load a show, see “Managing show files” on page 172.

The following table gives a description of each function button on the **Automation** screen that is used for the show files.

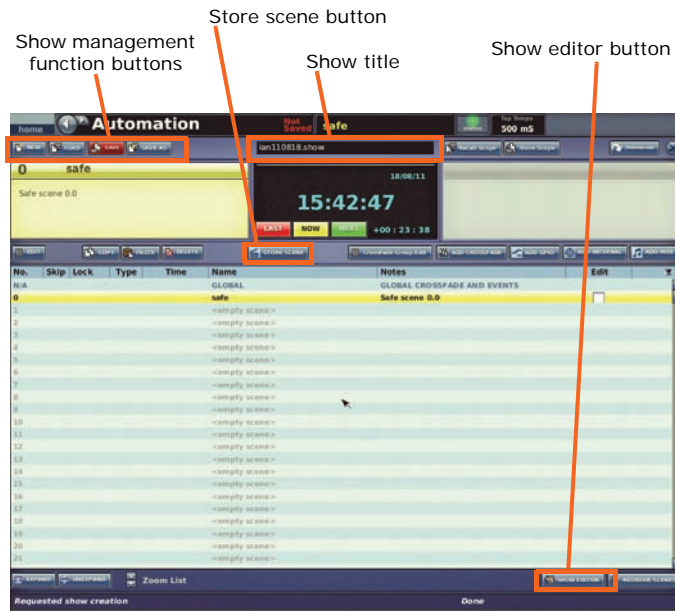

<i>Legend</i>	<i>Description</i>
<b>NEW</b>	For creating a new show (see “To create a new show” on page 82).
<b>LOAD</b>	For loading a stored show by restoring all stored snapshots and associated automation data from the selected show file (see “To load a show” on page 83).
<b>SAVE</b>	For backing up all stored snapshots and associated automation data to the selected/current show file (see “To save a show or create a new one from the current settings” on page 83). This button changes to red to show that there are show settings to be saved. We recommend that you save your show at regular intervals.
<b>SAVE AS</b>	Create a new show using the settings of the current one (see “To save a show or create a new one from the current settings” on page 83).
<b>STORE SCENE</b>	For details, see “To create a new scene using the current settings” on page 84.
<b>SHOW EDITOR</b>	For details, see “Show editor” on page 86.

### Managing show files on the Files screen

Show files can be transferred between the PRO2 and an external USB device, such as a USB memory stick. This allows you to backup and archive your show files, so none will be lost, and also transfer them to other PRO2s. You can even create templates for new shows, so that you don't have to start from scratch, or modify existing show files. All this is done via the Files screen (see "About the Files screen" on page 203).

For details of how to back up/export your files and also how to import them from an external source, see "Saving your show files to a USB memory stick" on page 91.

PRO2 are compatible with other Midas digital consoles, such as the PRO Series and XL8.

## Rehearsals

Rehearsal mode allows you to skip scenes/point scenes to match the arbitrary nature of the performance sequence during rehearsals.

### >> To select a scene to 'skip' and to 'unskip' a scene

See "Editing scene properties" on page 168.

### >> To carry out a rehearsal

- 1 Click **REHEARSAL**.
- 2 Carry out the rehearsal as necessary. (Note how the scenes selected as 'skipped' are missed out during the show's rehearsal, as you use the last, now and next buttons.)
- 3 To end the rehearsal, click **REHEARSAL**.

## Safes

### Important:

Safes are intended for emergency use only and are not to be confused with scope (see Chapter 21 "Scope (Automation)" on page 177).

PRO2 safes prevent certain controls from being recalled with a scene. Safe activation and status are provided on both the control surface (**channel safes** section) and the GUI (**Hardware Safe** screen).

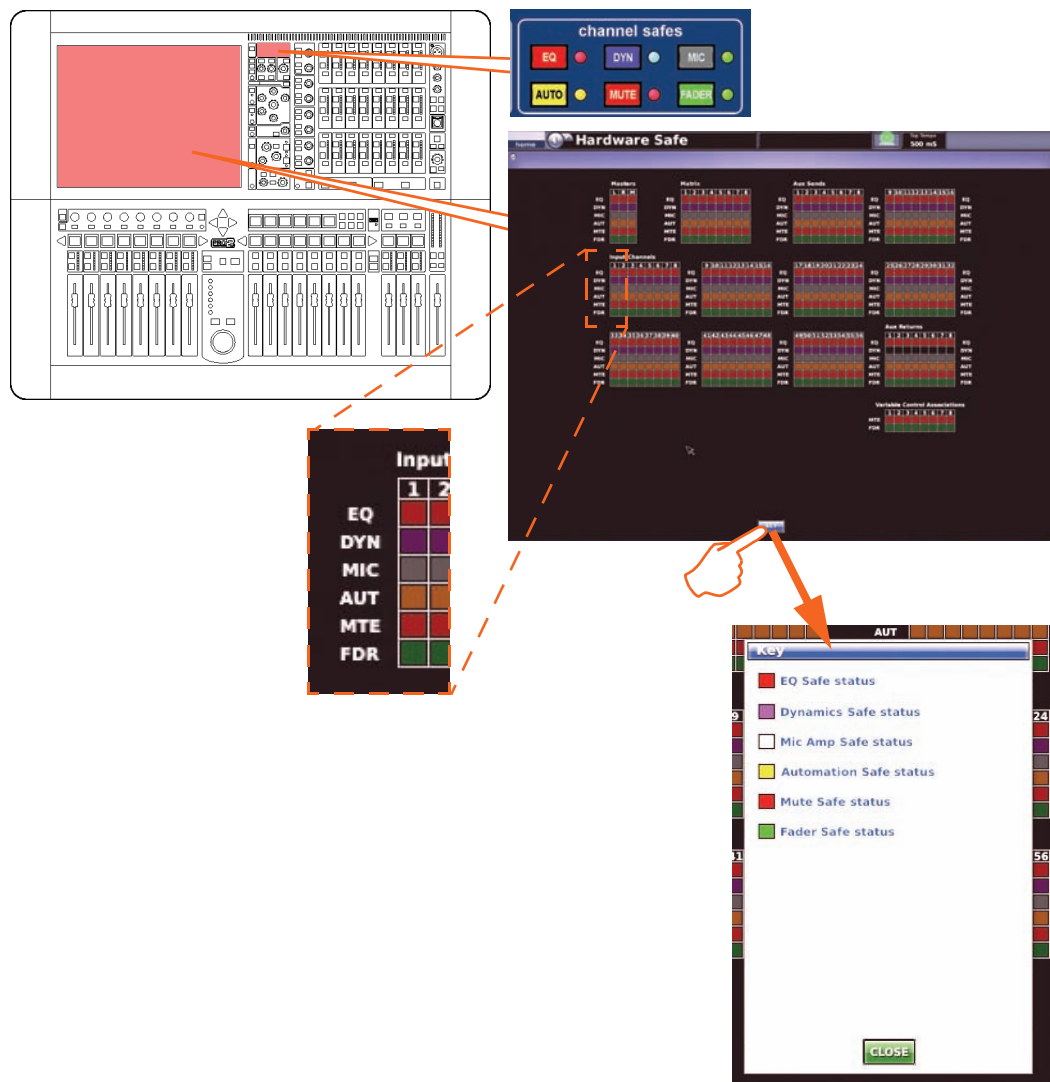

The **channel safes** screen on the control surface and the GUI **Hardware Safe** screen. Click **KEY** to open the **Key** window.

There are six types of channel safe: EQ, dynamic, mic, auto, mute and fader. These are available on all channels except aux returns, which don't have dynamic safes. The VCAs have mute and fader safes. Solo (for monitor areas A and B) is always out of scene on any channel.

For information on the channel and group parameters for each safe, see Appendix H "Parameters Protected By Safes" on page 385.

The **Hardware Safe** screen shows all of the available safes for the channels and VCAs. The **KEY** button opens a **Key** window that shows you what the safe buttons represent.



**>> To open the Hardware Safe screen**

At the GUI, choose **home ▶ Automation ▶ Hardware Safe**.

**>> To switch a safe on/off**

Do one of the following:

- At the GUI's **Hardware Safe** screen, click the desired safe to switch it on/off. This can be done for any safe.
- Use the appropriate button in the **channel safes** section with the appropriate channel assigned to the control surface.
- At the GUI's **VCA Groups** screen, click the desired safe button.



## Chapter 21: Scope (Automation)

This chapter shows you how to use the scope feature of PRO2 automation to include/exclude specific parameters on scene store/recall.

Although scope has two functions, recall and store, the emphasis in this chapter is on recall scope, which will be the most commonly used of them both. Store scope will only be required in certain circumstances, and even then it must only be used with caution (see “Using store scope” on page 183).

### About scope

Scope lets you define the extent of the automated controls for all channels, buses, groups, assignable effects and GEQs. To do this it has a **Recall Scope** screen from which you can select the controls that are excluded from the scene when it is recalled and you can also view the current scope status.

### About the Recall Scope screen

The **Recall Scope** screen has a number of type-specific areas, such as **Input Channels**, **Aux Sends**, **VCA**s and **Graphic EQ**s, which contain user-selectable parameter sections that you can make ‘out of scene’ on scene recall.

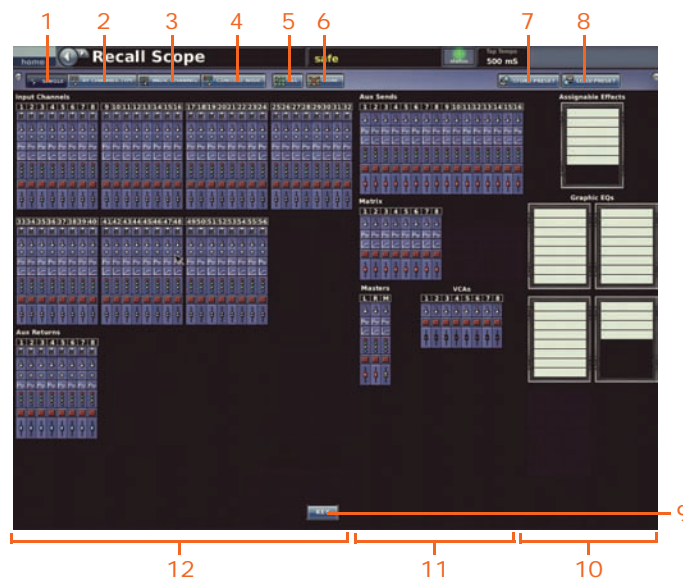

Elements of the PRO2 **Recall Scope** screen





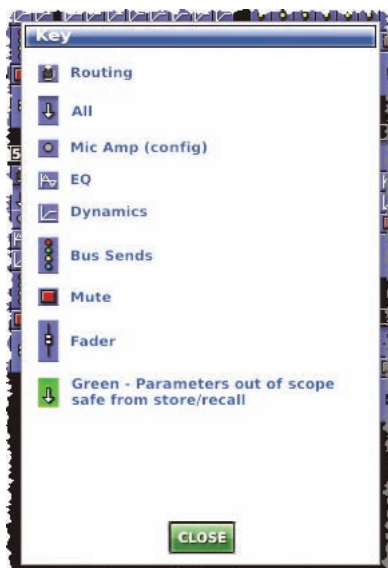



Item	Element	Description
1	<b>SINGLE</b> button	Scope function button for selecting single parameter sections on the scope screen.
2	<b>BY CHANNEL TYPE</b> button	Scope function button for selecting the same parameter section in all channels of a single type on the scope screen.

<i>Item</i>	<i>Element</i>	<i>Description</i>
3	<b>INDV. CHANNEL</b> button	Scope function button for selecting all of the parameter sections of a single channel on the scope screen.
4	<b>CONSOLE WIDE</b> button	Scope function button for selecting all of the parameter sections of every channel on the scope screen.
5	<b>ALL</b> button	Scope function button that selects all of the parameter sections on the scope screen, that is, for every channel, assignable effect and internal GEQ.
6	<b>NONE</b> button	Scope function button that deselects all selected parameters sections on the scope screen.
7	<b>STORE PRESET</b> button	See Chapter 24 "User Libraries (Presets)" on page 235.
8	<b>LOAD PRESET</b> button	See Chapter 24 "User Libraries (Presets)" on page 235.
9	<b>KEY</b> button	Opens the Key window (below), which shows you what each parameter section symbol represents.
10	Rack units	Area for the assignable effects and GEQs.
11	Output channels	Area for the aux sends, matrices, VCAs and masters.
12	Input channels and groups	Area for the inputs and aux returns.



The **Key** window, which is opened by clicking the **KEY** button

The **Recall Scope** screen has a section for each of the following.

<i>Description</i>	<b>Input Channels</b>	<b>Aux Returns (returns)</b>	<b>Aux Sends (auxes)</b>	<b>Matrix (matrices)</b>	<b>Masters</b>	<b>Variable Control Associations (VCA and POP. groups)</b>	<b>Assignable Effects (internal effects) and Graphic EQs</b>	<i>Symbol</i>
<b>Routing</b>	Yes	Yes	No	No	No	No	N/A	
<b>All</b>	Yes	Yes	Yes	Yes	Yes	Yes	N/A	
<b>Mic Amp (config)</b>	Yes	Yes	No	No	No	No	N/A	
<b>EQ</b>	Yes	Yes	Yes	Yes	Yes	No	N/A	
<b>Dynamics</b>	Yes	No	Yes	Yes	Yes	No	N/A	
<b>Bus Sends</b>	Yes	Yes	Yes	No	Yes	No	N/A	
<b>Mute</b>	Yes	Yes	Yes	Yes	Yes	Yes	N/A	
<b>Fader</b>	Yes	Yes	Yes	Yes	Yes	Yes	N/A	
<b>Assignable Effects/Graphic EQ</b>	N/A	N/A	N/A	N/A	N/A	N/A	Yes	

>> **To open the Recall Scope screen**

At either GUI screen, choose **home ▶ Automation ▶ Recall Scope**.

## Selecting scope parameter sections

The scope function buttons provide a number of ways of selecting/deselecting scope parameters, such as singly, by channel type, all on the control centre etc.

When a parameter is selected, its background changes from blue  to green .

Selection is cumulative, so you can combine any of the selection/deselection functions until all the desired parameter sections have been selected. When you have finished the selection process, just go to the next screen you require; you don't have to save your selection, as it remains stored in the current condition until you alter it again.

The "Assignable Effects" panel lets you choose which effects are 'out of scene' on scene recall.

For details of the parameters affected by scope, see Appendix K "Parameters Affected By Scope" on page 421.

### >> To select a single parameter section

- 1 Click **SINGLE**.
- 2 Click the desired parameter section.

In some cases more than one parameter section may be selected. This may occur if:

- The parameter section belongs to a channel that is stereo linked. The equivalent parameter section of the other paired channel will also be selected.
- Other channels are patched to the same source as the channel in which you are making your selection. This only applies to the **All** and **Mic Amp** parameter sections.

### >> To select a parameter section in all channels of a single type

- 1 Click **BY CHANNEL TYPE**.
- 2 Click the desired parameter section in any channel of the desired type. For example, click the routing parameter section in any of the input channels. The routing parameter section on all input channels will be selected (as shown right).



### >> To select all of the parameters of a single channel

- 1 Click **INDV. CHANNEL**.
- 2 Click any parameter section in the desired channel. For example, click the **All** parameter of input channel 5; all the parameter sections in channel 5 are selected (as shown right).

If the channel is stereo linked, all of the parameter sections in its paired channel will also be selected.



>> To select a single parameter section console wide

- 1 Click **CONSOLE WIDE**.
- 2 In any channel, click the desired parameter section. For example, clicking the fader parameter of input channel 1 selects the fader parameter of every channel.

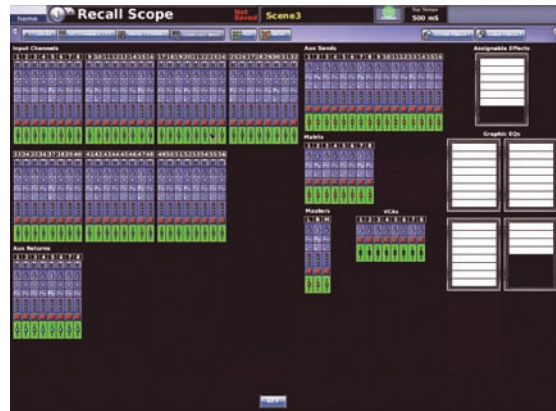

>> To select every parameter section on the console

Click **ALL**. Every parameter section on the **Recall Scope** screen is selected (as shown right).

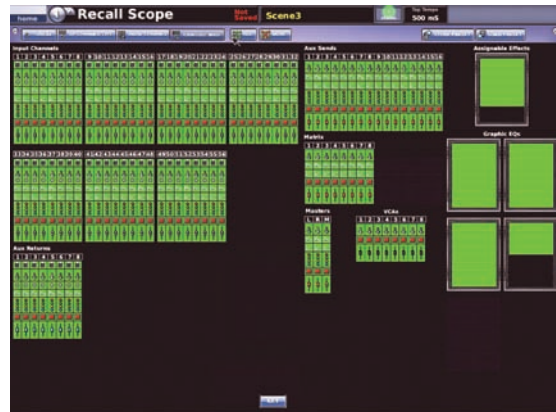

>> To deselect a parameter section(s)

Follow the procedures for selecting parameters, but only click ones that are already selected.

### Selecting bus parameters

As a channel's bus parameter section represents all of its available buses collectively, you can only select either all or none of its buses using the scope function buttons. However, by clicking the bus parameter section you can open its 'bus select' window, which lets you select any buses you want out of scene. In this window each aux/matrix bus is represented by an single icon, and only available buses are shown.

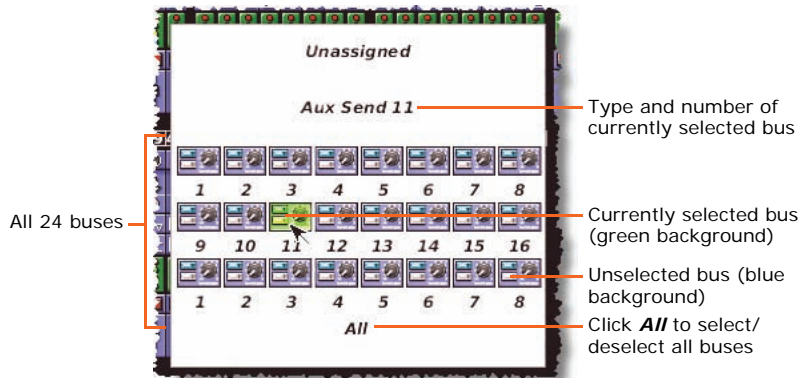

Typical 'bus select' window

The background colour of the bus parameter for each channel shows the selection status of its respective buses. There are three states, as shown in the following table.

<b>Bus selection status</b>	<b>Symbol</b>
None of the buses are selected	
One or more, but not all, of the buses are selected	
All of the buses are selected	

#### >> To select/deselect buses

In the 'bus select' window, do one of the following:

- To select/deselect a single bus, click on its icon.
- To select/deselect all buses, click **All**.



## Saving scope parameters in a scene

Scope parameters have to be saved in a scene.

### >> To save your selected parameters in a scene

- 1 Save the parameters you want into a scene (see “To create a new scene using the current settings” on page 59).
- 2 Select the desired recall scope parameters (see “Selecting scope parameter sections” on page 179).
- 3 Overwrite the scene by clicking the “Overwrite scene” option (see “To create a new scene using the current settings” on page 59).

## Using store scope

**!** Although store scope is sometimes useful in very specific situations, it must always be used with care. This is because it is possible that control settings will not be stored at all and will consequently be lost. Therefore, it is much safer to use recall store and always store everything.

Please use store scope with great care. All of the methods of the recall scope operation, as detailed in this chapter, apply equally to store scope.



## Chapter 22: Events (Automation)

This chapter shows you how to use the events of the PRO2's automation.

### About events

There are four types of event — MIDI, GPIO, internal and crossfade — that you can have in a scene, and you can have any combination of each. You can choose whether the event is triggered on the PRO2 or on an external device.

For more information on events and also how to create, edit and copy/paste an event, see "Additional control — managing events" on page 85.

### MIDI

MIDI performs two functions on the PRO2. It allows the PRO2 to trigger external MIDI-equipped equipment on each scene change and it also allows external MIDI equipment to trigger a PRO2 scene change.

MIDI output from the PRO2 can include a globally-enabled outgoing message that contains the recalled scene number and is sent out for all recalled scenes. Also, up to eight messages with user-selectable content are stored per scene and sent out whenever the scene is recalled.

MIDI input can be globally set up to cause scenes to be recalled when specific incoming MIDI messages are encountered.

### GPIO

The general purpose input and output (GPIO) on the PRO2 is used to control/respond to various devices. You can use GPIO inputs to control PRO2 parameters from an external device, for example, you can use an external switch to switch the PRO2's talkback on/off or you can use an external switch or joystick to control the PRO2's parameters. You can also use the PRO2's keys and faders to send control signals to an external device.

### Internal

You can create an event on the PRO2 without using an external device; this type of event is called an "internal" event. This means that an event is triggered and carried out entirely on the PRO2.

### Crossfades

For information on crossfades, see Chapter 23 "Crossfades (Automation)" on page 191.

## About the Edit Event window

You can edit the parameters of an event in the **Edit Event** window.

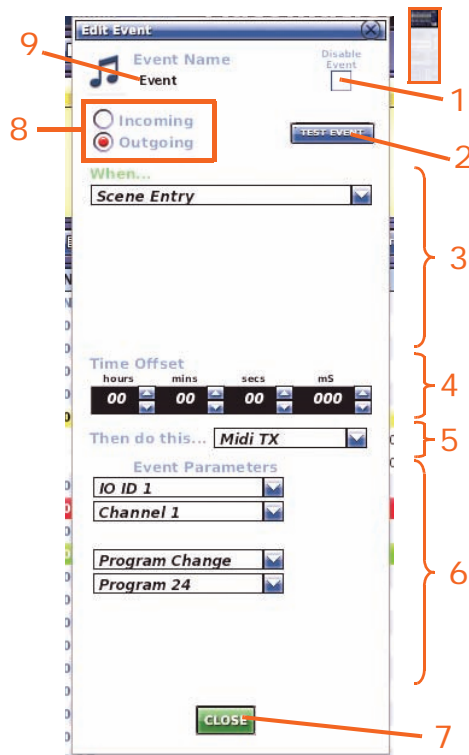

Item	Description
1	<b>Disable Event</b> tick box, for choosing whether the event is missed out (skipped) during a rehearsal.
2	<b>TEST EVENT</b> button, for executing the selected outgoing MIDI or GPIO event using the current event parameters.
3	<b>When...</b> section for selecting the parameters that trigger the event. Displays either one or three drop-down lists, depending on the whether the event is selected as <b>Outgoing</b> or <b>Incoming</b> , respectively.
4	<b>Time Offset</b> section, for setting the period of time that the event happens after it has been triggered. Zero = no offset.
5	<b>Then do this...</b> section, for choosing the type of event that you want.
6	<b>Event Parameters</b> section (see the "Programming events" on page 187).
7	<b>CLOSE</b> button, for closing the <b>Edit Event</b> window.
8	Incoming/outgoing selection section, for selecting whether the event is triggered on the PRO2 or on an external device.
9	Text field, for displaying the user-configured event name.

Figure 15: Edit Event window

## Programming events

Each type of event is programmed in a similar way, regardless of whether it is an incoming/outgoing MIDI or GPIO event, or an internal event. However, the options in the **Edit Event** window may vary depending on the chosen event.

### >> To program an event

- 1 Open the **Edit Event** window (see “To edit an event” on page 85).
- 2 In the **Event Name** section, type in the event name. If you want to skip this event during a rehearsal, select the **Disable Event** option.
- 3 To select whether the event occurs on the PRO2 or an external device, click **Incoming** or **Outgoing**, respectively. (This is not applicable to internal events.)
- 4 Select the desired parameters in the **When...**, **Then do this...** and **Event Parameters** sections. To help you, refer to Table 6 “Outgoing event options” (below), Table 7 “Incoming event options” on page 188 and Table 8 “Description of all event option parameters” on page 188.
- 5 If you want to incorporate a time delay between the event being triggered and the event itself, select a time in the **Time Offset** section (click the up/down spin buttons).
- 6 Click **CLOSE**.

**Table 6: Outgoing event options**

<i>When ...</i>	<i>Then do this...</i>	<i>Event Parameters (from top list downwards)</i>				
<i>Scene Entry,</i>	<i>Midi TX</i>	<i>IO ID1 to IO ID 18</i>	<i>Channel 1 to Channel 16</i>	<i>Note Off,</i>	<i>A0 to C7</i>	<i>Velocity 0 to 127</i>
<i>Scene Exit,</i>				<i>Note On,</i>	<i>A0 to C7</i>	<i>Velocity 0 to 127</i>
<i>Scene Recall,</i>				<i>Aftertouch,</i>	<i>A0 to C7</i>	<i>Pressure 0 to 127</i>
<i>Scene Entry And Recall</i>				<i>Pressure,</i>	N/A	<i>Pressure 0 to 127</i>
<i>Scene Entry And Exit</i>				<i>Control Change,</i>	<i>All Notes Off, Reset All</i>	N/A
<i>Scene Entry, Exit And Recall</i>				<i>Program Change</i>	<i>Program 0 to 128</i>	N/A
	<i>GPIO TX</i>	<i>IO ID1 to IO ID 18</i>	<i>Static Low, Static High</i>	<i>Closure 1 to Closure 8</i>	N/A	N/A
	<i>Last</i>	N/A	N/A	N/A	N/A	N/A
	<i>Next</i>	N/A	N/A	N/A	N/A	N/A
	<i>Now</i>	N/A	N/A	N/A	N/A	N/A
	<i>Jump</i>	List of scene titles	N/A	N/A	N/A	N/A
	<i>Notes Event</i>	<b>Event Parameters</b> section changes to a <b>Notes</b> window, where you can enter event notes				
	<i>X-Fade Event</i>	<b>Event Parameters</b> section changes to crossfades parameter display				

Table 7: Incoming event options

<i>When ... (from top list downwards)</i>			<i>Then do this...</i>	<i>Event Parameters (from top list downwards)</i>
<i>Any IO Box,</i>	<i>Any MIDI Channel,</i>	<i>Note Off,</i>	<i>Midi TX</i>	For details, see Table 7 "Incoming event options" on page 188
<i>IO ID1 to IO ID 18</i>	<i>Channel 1 to Channel 16</i>	<i>Note On,</i>	<i>GPIO TX</i>	
		<i>Aftertouch,</i>	<i>Last</i>	
		<i>Pressure,</i>	<i>Next</i>	
		<i>Control Change,</i>	<i>Now</i>	
		<i>Program Change,</i>	<i>Jump</i>	
		<i>Pitch Wheel</i>	<i>Notes Event</i>	
			<i>X-Fade Event</i>	

Table 8: Description of all event option parameters

<i>Parameter</i>	<i>Description</i>
<b>Aftertouch</b>	How hard a key is pressed after it has been touched, that is, it changes the pressure after the note has been hit. Typically, aftertouch is useful for adding tremolo or vibrato effects to a sound, just as a violin can add volume or pitch changes to a sustained note using finger vibrato or addition bowing intensity.  Parameters for <b>Aftertouch</b> are notes A0 to C7, with each having a possible pressure of between 0 and 127. You can also choose between <b>Enable MIDI Byte 1</b> and <b>Enable MIDI Byte 2</b> .
<b>Any IO Box</b>	The trigger can be on any IO port of any IO box.
<b>Any MIDI Channel</b>	Any of the MIDI channels.
<b>Channel <i>n</i></b>	One of the 16 MIDI channels.
<b>Closure <i>n</i></b>	Provides a contact closure that can be programmed to open or close in response to a MIDI event.
<b>Control Change</b>	Select the control changes that can be applied to a note in progress. For example, by altering the volume (not velocity) or adding sustain to a note (holding it for longer).  Parameters are <b>All Notes Off</b> and <b>Reset All</b> . You can also choose between <b>Enable MIDI Byte 1</b> and <b>Enable MIDI Byte 2</b> .
<b>FOH MIDI PORT</b>	The trigger is via the MIDI port of the FOH DL251/DL252 Audio System I/O.
<b>GPIO TX</b>	Selects a GPIO event.
<b>IO ID<i>n</i></b>	The trigger is via a specific IO port.
<b>Jump</b>	Opens a specified scene on the PRO2.
<b>Last</b>	Opens the last (previous) scene on the PRO2. This scene is the same one that would be opened if you pressed the <b>last</b> button.
<b>MIDI TX</b>	Selects a MIDI event.

<i>Parameter</i>	<i>Description</i>
<b>Next</b>	Opens the next scene on the PRO2. This scene is the same one that would be opened if you pressed the <b>next</b> button.
<b>Now</b>	Opens the 'now' scene on the PRO2. This scene is the same one that would be opened if you pressed the <b>now</b> button.
<b>Note Off</b>	<p>Informs the instrument to stop playing a note at a specified pitch and velocity.</p> <p>Parameters for <b>Note Off</b> are notes A0 to C7, with each having a possible velocity of between 0 and 127. You can also choose between <b>Enable MIDI Byte 1</b> and <b>Enable MIDI Byte 2</b>.</p>
<b>Note On</b>	<p>Informs the instrument to start playing a note at a specified pitch and velocity.</p> <p>Parameters for <b>Note On</b> are notes A0 to C7, with each having a possible velocity of between 0 and 127. You can also choose between <b>Enable MIDI Byte 1</b> and <b>Enable MIDI Byte 2</b>.</p>
<b>Notes Event</b>	Using this option, you can displays notes that may be useful at a certain point in the scene.
<b>Pitch Wheel</b>	Use the pitch wheel to trigger the event. The pitch wheel is a wheel type device, normally found to the left of a synthesizer keyboard, that manipulates the pitch of a played note(s).
<b>Pressure</b>	<p>Pressure applied to the key that is being pressed. This affects, for example, the vibrato of the note being played.</p> <p>Parameters are between 0 and 127. You can also choose between <b>Enable MIDI Byte 1</b> and <b>Enable MIDI Byte 2</b>.</p>
<b>Program <i>n</i></b>	One of the 128 programs.
<b>Program Change</b>	<p>Changes the device to a particular patch/voice/preset etc.</p> <p>Parameter are 0 to 127. You can also choose between <b>Enable MIDI Byte 1</b> and <b>Enable MIDI Byte 2</b>.</p>
<b>Scene Entry</b>	Triggers the event when a scene is opened.
<b>Scene Exit</b>	Triggers the event when a scene is closed.
<b>Scene Recall</b>	Triggers the event when the 'now' scene is reloaded, but not jogged to.
<b>Scene Entry And Exit</b>	Triggers the event when a scene is opened or closed.
<b>Scene Entry And Recall</b>	Triggers the event when a scene is opened or the 'now' scene is reloaded (but not jogged to).
<b>Scene Entry, Exit And Recall</b>	Triggers the event when a scene is opened, closed or the 'now' scene is reloaded (but not jogged to).
<b>Static High</b>	External device is closed/switched off.
<b>Static Low</b>	External device is opened/switched on.
<b>X-Fade Event</b>	Lets you configure the crossfade event.





## Chapter 23: Crossfades (Automation)

This chapter shows you how to use crossfades.

Crossfades are events that are triggered using the standard event mechanism, and are managed via the **Automation** screen. A crossfade event is managed in a similar way to any other event, such as GPIO and MIDI, and is detailed later on in this section.

A crossfade event is a trigger to change the value of a control — most often but not always a fader — between two levels, that of the current control position and that of the position in another scene, over time. If the level in the next scene is higher than the current level, the crossfade uses the 'fade up' time; if it is lower, it uses the 'fade down' time.

### About the crossfade Edit Event window

You can edit the parameters of a crossfade event in the **Edit Event** window.

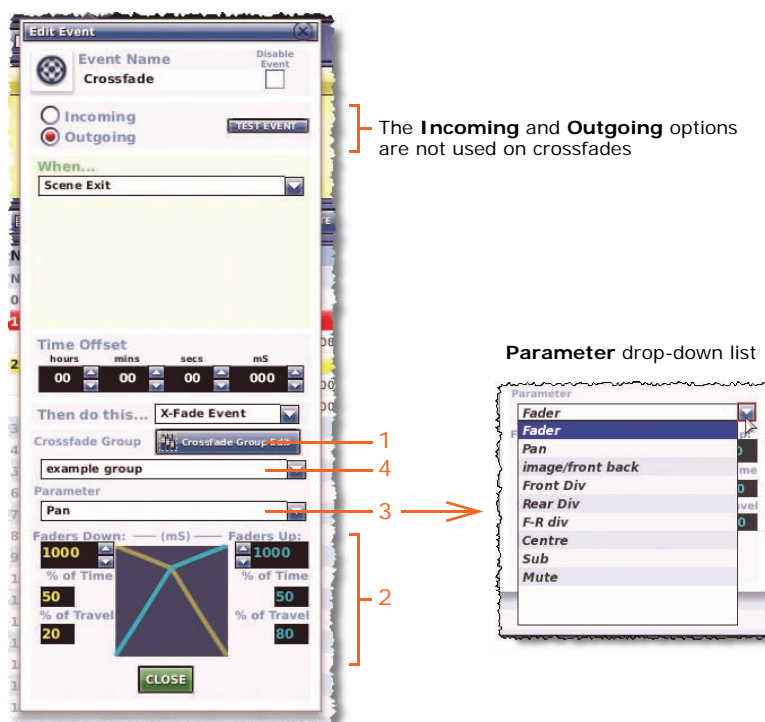

Crossfade **Edit Event** window (for details of the Edit Event window elements that are common to each event type, see Figure 25 "Edit Event window" on page 222)

Item	Element	Description
1	Crossfade Group Edit button	Opens the <b>Crossfade Groups</b> screen (see "Crossfade groups" on page 195).
2	Crossfade set up section	See "Crossfade set up section in the Edit Event window" on page 193.

Item	Element	Description
3	Parameter drop-down list	For choosing the level control that you want the crossfade to operate on (see “About the crossfade parameters” on page 192).
4	Crossfade Group drop-down list	Contains all of the available user-configured crossfade groups. Also includes the default <b>example group</b> that contains all possible crossfade sources.

**About the crossfade parameters**

The following diagram shows the PRO2 configured for 5.1 surround mode, which utilises each available parameter option. The presence of the **divergence**, **centre level** and **LFE level** sections are dependent on the currently selected surround mode.

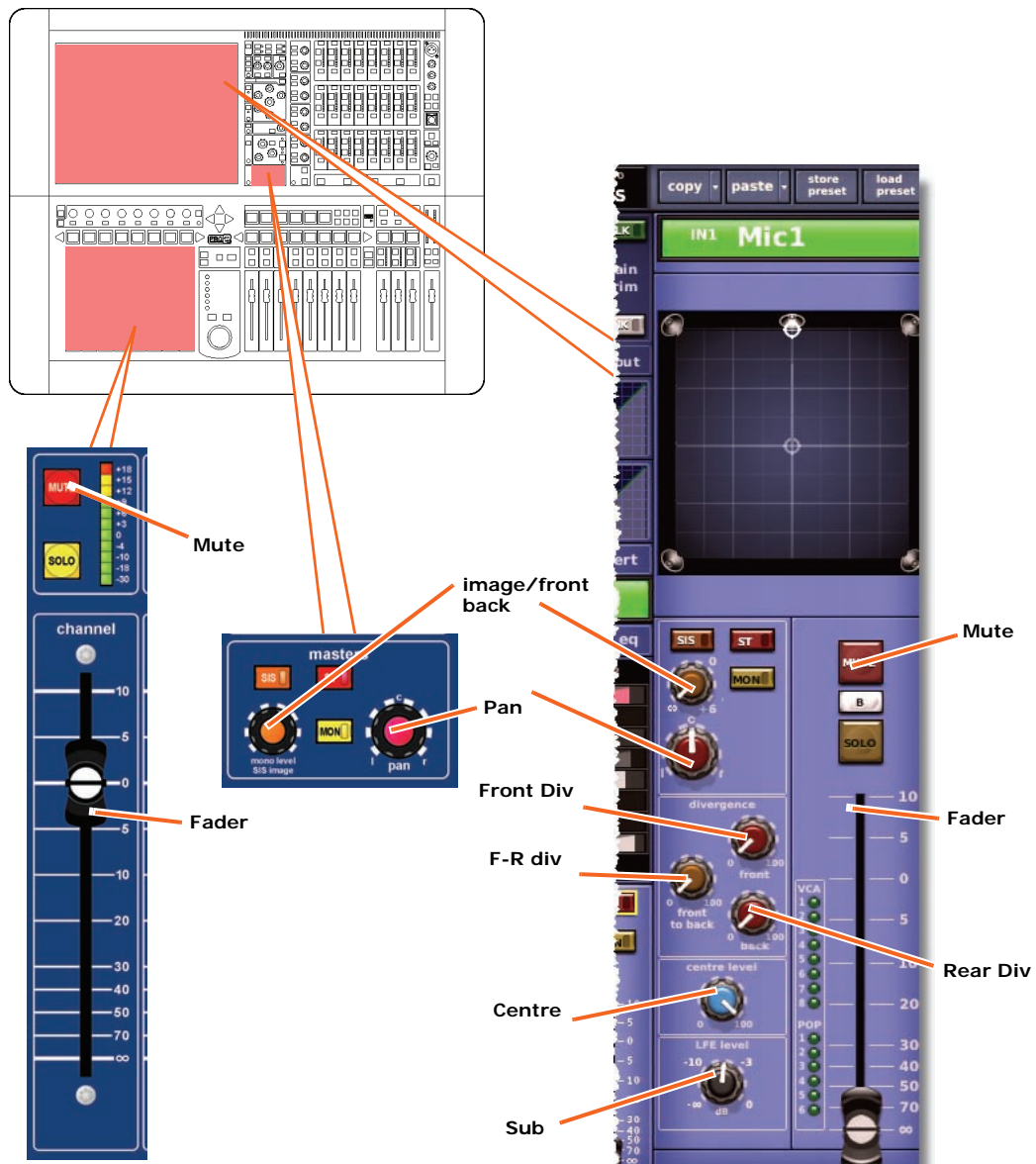

**Using a crossfade mute**

The **Mute** option of the **Parameters** list lets you initiate a mute at the end of a crossfade down operation. For example, if you set a crossfade of two seconds, the mute will turn on after this time has expired (provided it was off). If the crossfade is a 'crossfade up', the mute will turn off during the crossfade up time (provided it was on).

**Crossfade set up section in the Edit Event window**

The crossfade set up section (bottom of the **Edit Event** window) is where you set up how the crossfade operates. Here you can set up the duration of the crossfade and the rate at which it occurs. You can configure two crossfade rates per crossfade or keep its rate constant throughout.

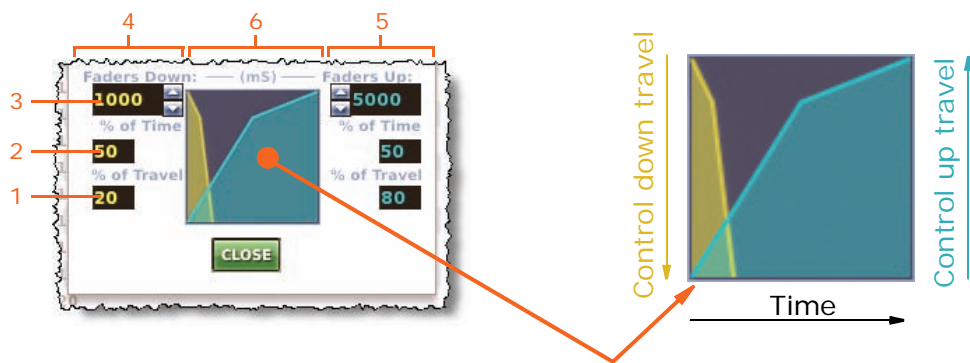

Figure 16: Crossfade set up section

Item	Element	Function
1	% of Travel number field	Sets the initial travel distance of the control as a percentage of the total distance of travel.
2	% of Time number field	Sets the time for the initial travel of the control as a percentage of the overall time.
3	Faders Down field	Sets the time taken for the total travel (milliseconds) of the control for a 'fader down' (or whichever control is used) crossfade event. For the <b>Faders Up</b> field, this sets the time taken for the total travel (milliseconds) of the control for a 'fader up' crossfade event.
4	Faders down section	For setting the crossfade down parameters.
5	Faders up section	For setting the crossfade up parameters.
6	Graph	Up/down crossfade graph.

**>> To quickly adjust the time and travel of the faders up/down**

You can quickly adjust the **% of Time** and **% of Travel** parameters by dragging the graph. Click anywhere on the line of the graph in the **Edit Event** window and drag to where the parameters are as desired. Clicking while pressing the left button adjusts the down travel, and doing the same with the right button adjusts the up travel.

## &gt;&gt; To create a crossfade event

- 1 Open the **Edit Event** window.
- 2 If you want to disable this event, select the **Disable Event** option.
- 3 In the **When...** section, select the parameters that will trigger the event.
- 4 If you want to incorporate a time offset delay between the event being triggered and the start of the event, set a time in the **Time Offset** section.
- 5 In the **Then do this...** drop-down list, select the **X-Fade Event** option.
- 6 Do one of the following:
  - Select a crossfade group from the **Crossfade Group** drop-down list.
  - Create a new crossfade group. Click the **Crossfade Group Edit** button to open the **Crossfade Groups** screen and then follow the instructions in "Crossfade groups" on page 195.
- 7 In the **Parameters** section, select the level control on which you want the crossfade event to occur (see "Programming events" on page 223). For example, a fader.
- 8 In the crossfade set up section (see "Crossfade set up section in the Edit Event window" on page 193), set up the crossfade parameters, such as time, % of travel etc.
- 9 Click **CLOSE**.

To set up a crossfade to have a constant rate across its full travel, set both the **% of Time** and **% of Travel** fields to 50%.

## How a crossfade operates

When the crossfade event is triggered, the time offset (if configured) will start.



*In the cue list, a blue status bar in a crossfade event will show the progress of a time offset*

After the time offset has finished, the crossfade will start; this will be either a down or up crossfade, depending on the current control level. During the crossfade, the control level will alter at the configured rate, shown on both the control surface and GUI. Progress is shown in real time on the **Automation** screen.

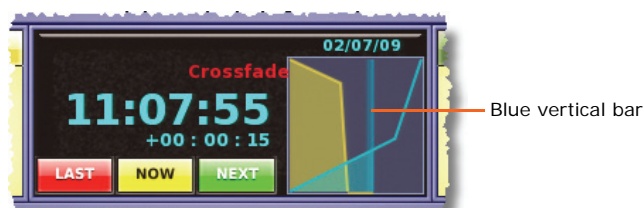

*Typical crossfade graph in the Automation screen. The blue vertical bar will travel from left to right according to the time elapsed and at the configured crossfade rate.*

**Note:** The graph display shows the current longest crossfade in progress. So, if a delayed crossfade starts during the current one, and it is longer than the current one, the graph will change to show the new crossfade.

You can manually override the crossfade using the controls in the automation section of the output bay (see “Manually controlling a crossfade” on page 198).

## Crossfade groups

Crossfade groups let you choose which channels/buses/groups will contain the crossfade. These groups are managed at the GUI’s **Crossfade Groups** screen.

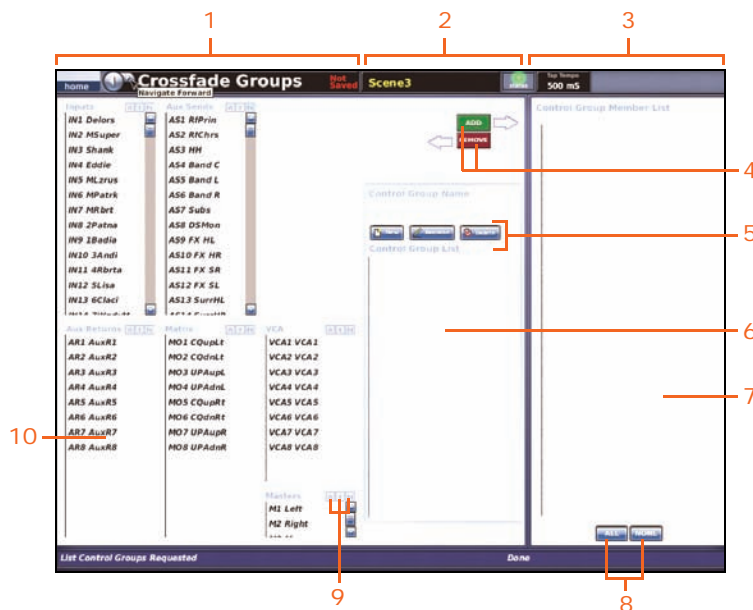

*Crossfade Groups* screen

Item	Description
1	Crossfade control group member source panel. Contains panels of channels, buses and groups from where you select the sources for your crossfade group.
2	Crossfade group management section, where you can create new crossfade groups or delete existing ones, add/remove members to/from the currently selected group, and select the desired group from the <b>Control Group List</b> .
3	Crossfade group member panel.
4	<b>ADD</b> and <b>REMOVE</b> buttons. These buttons add or remove the currently selected members to or from the <b>Control Group Member List</b> , respectively.
5	<b>New</b> , <b>Rename</b> and <b>Delete</b> buttons. These buttons let you create, rename or delete crossfade control groups, respectively.
6	<b>Control Group List</b> , which shows the existing crossfade control groups.
7	<b>Control Group Member List</b> , which shows the current members of the selected crossfade control group.
8	<b>ALL</b> and <b>NONE</b> buttons. These buttons select all or none of the members in the <b>Control Group Member List</b> , respectively.

<i>Item</i>	<i>Description</i>
9	<b>A, I and N</b> buttons. Each section in the crossfade source panel has a set of these buttons, which select all members in the list, invert the current list selection or deselect all members in the list, respectively.
10	A panel containing a list of channels, buses or groups available for crossfade group membership.

### >> To open the Crossfade Groups screen

At the GUI menu's **Automation** screen, click **Crossfade Group Edit**.

### >> To create a new crossfade group

- 1 At the **Crossfade Group** screen, click **New**.
- 2 In the **Enter new control group name:** prompt window, type in your chosen name for the new crossfade group.
- 3 Click **OK**. The new group will appear in the **Control Group List**.



### >> To edit a crossfade group

- 1 In the **Crossfade Group List** panel, select the crossfade group you want to edit.
- 2 Do one of the following:
  - To add members to the group, select the members from the lists of inputs, auxes, returns, matrices, masters and groups at the left of the screen and then click **ADD**. The selected items will be moved to the **Control Group Member List**.
  - To remove members from the group, select the members in the **Control Group Member List** that you want to remove and then click **REMOVE**. The selected items will be moved back to their respective panels in the left of the **Crossfade Group** screen.

If you want, you can edit the "example group" crossfade control group.

### >> To rename a crossfade group

- 1 In the **Crossfade Group List** panel, select the crossfade group you want to rename.
- 2 In the **Rename control group as:** prompt window, type in the new name for the crossfade group.
- 3 Click **OK**. The new name will appear in the **Control Group List**.



If you want, you can rename the "example group" crossfade control group.



**>> To delete a crossfade group**

In the **Crossfade Group List** panel, select the crossfade group you want to delete and then click **Delete**.

You cannot delete the "example group" crossfade control group.

**Global events**

The **GLOBAL** scene, at the top of the cue list in the **Automation** screen, lets you have the same crossfade(s) in every scene. However, any scene-based crossfade(s) will override the global one(s) if both are present.

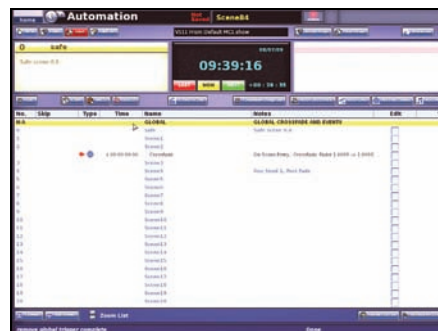
**>> To set up a global crossfade**

Select the **GLOBAL CROSSFADE AND EVENTS** scene and do one of the following:

- Click **ADD CROSSFADE**.
- From the right-click menu, choose **Add ▶ Crossfade Event**. The crossfade will appear in the **GLOBAL CROSSFADE AND EVENTS** scene.



**GLOBAL** scene (highlighted in yellow) in the **Automation** screen

## Manually controlling a crossfade

The controls in the **automation** section let you manually override the crossfade.

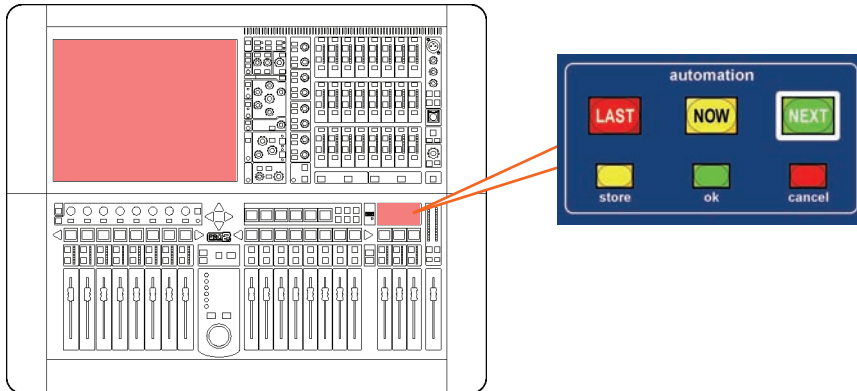

The **cancel**, **now** and **ok** buttons in the automation section

<b>Control</b>	<b>Function during crossfade</b>
<b>cancel</b> button	<p>Pauses the crossfade. Pressing the <b>cancel</b> button again, while the crossfade is paused, cancels the crossfade.</p> <p><b>Note:</b> The level of the control on which the crossfade is operating will remain at the point at which it was paused. If you restart the crossfade the control will travel over the full crossfade period, that is, if you stop (rather than pause) a five-second crossfade at two seconds and restart it, it will take the control five seconds to move to the final position, and not three seconds.</p>
<b>now</b> button	Pressing this button while the crossfade is paused (by pressing the <b>cancel</b> button), continues the crossfade.
<b>ok</b> button	Jumps to the end of the crossfade, effectively cancelling the remaining time to the end of the crossfade.



## Chapter 24: User Libraries (Presets)

User libraries is a GUI only feature that provides a method of handling presets. The GUI menu has an option that opens the **Preset Manager** screen.

For more information on presets, including details of how to save and load a preset, see “User library (presets)” on page 88.

### About the Preset Manager screen

Using the **Preset Manager** screen, you can create new user libraries, load existing ones or save the current one. You can create a new user library from scratch or save the current one under a new name. Similarly to show files, you can import libraries from external storage devices (USB memory sticks).

The **Preset Manager** screen also allows you to delete presets from the currently loaded library.

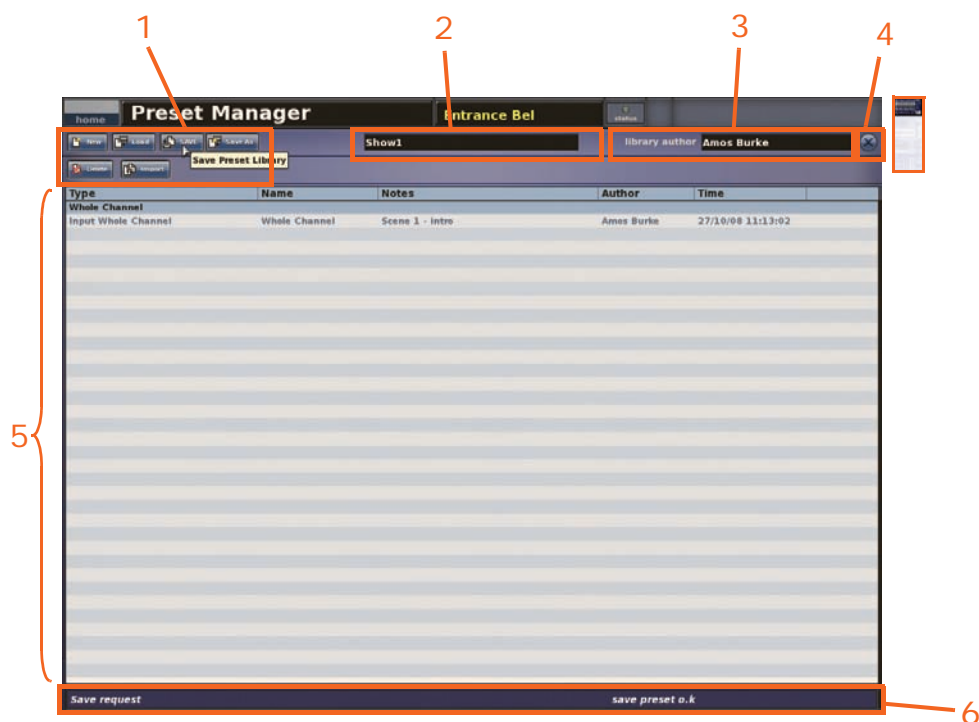

Item	Description
------	-------------

- |   |  |
|---|--|
| 1 | <b>Preset Manager</b> screen function buttons for creating/loading/saving/importing user libraries. For a description of each button, see Table 9 “Description of Preset Manager screen function buttons” on page 200. |
| 2 | User library name.   |
| 3 | <b>library author</b> field, displays the name of user library author/creator.   |
| 4 | Close button, closes the <b>Preset Manager</b> screen.   |

<i>Item</i>	<i>Description</i>
5	List of presets in the user library. For a description of the column titles, see Table 10 "Description of preset list titles" on page 200.
6	Operation status information.

**Table 9: Description of Preset Manager screen function buttons**

<i>Button</i>	<i>Use to</i>
<b>New</b>	Create a new preset library.
<b>Load</b>	Load a preset library.
<b>SAVE</b>	Save any unsaved changes that have been made to the currently loaded preset library.
<b>Save As</b>	Create a new preset library from the current one.
<b>Delete</b>	Delete the currently selected preset.
<b>Import</b>	Import all presets from a preset library into the one currently loaded.

**Table 10: Description of preset list titles**

<i>Title</i>	<i>Description</i>
<b>Type</b>	Preset type.
<b>Name</b>	User-entered preset name.
<b>Notes</b>	User-entered preset notes.
<b>Author</b>	User-entered name of preset author/creator.
<b>Time</b>	Time that preset was created.

**>> To open/close the Preset Manager screen**

To open the Preset Manager screen, at the GUI choose **home ▶ Preset Manager**. To close it, Click **X** at the upper-right corner of screen.

## Managing user libraries

The background of the **SAVE** button in the **Preset Manager** screen changes to red when changes have been made to the current user library, but they haven't yet been saved. We recommend that you save these changes regularly.

### >> To create a new preset library

**1** In the **Preset Manager** screen, click **New**.

**2** In the "Enter new Library name:" message window (shown right), do the following:

- Type in the name of the new preset library in the text field containing the text "Libraryname".
- Type in your name in the text field containing the text "Author".

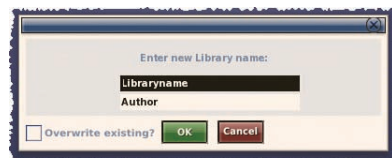

You can also replace an existing preset library. To do this, type in its exact name in the "Libraryname" text field and then click the **Overwrite existing?** box to tick it.

**3** Click **OK**. A new **Preset Manager** screen will open.



*Don't forget that you can use the right-click **Cut**, **Copy** and **Paste** options when editing the text fields.*

### >> To load a preset library

**1** In the **Preset Manager** screen, click **Load**.

**2** In the **Load File** window, click the preset library you want to load. Its name will appear in the "Load this file:" text field.

**3** Click **OK**.

### >> To save changes to the currently selected preset library

At the **Preset Manager** screen, click **SAVE**.

If the **SAVE** button is red (shown right), there are unsaved changes; this button changes back to blue after the library has been saved (updated).



### >> To create a new preset library from the current one

**1** In the **Preset Manager** screen, click **Save As**.

**2** In the **Save File** window, type your chosen name for the new preset library in the "Save this file as:" text field.

You have the option to overwrite one of the existing preset libraries. Do this by clicking it in the **Save File** window and then ticking the **Overwrite existing?** option.

**3** Click **OK**. The new preset library will be selected.

**>> To import a preset library into the one currently selected**

- 1** In the **Preset Manager** screen, click **Import**.
- 2** In the **Load File** window, click the preset library whose contents you want to import.
- 3** Click **OK**.

If the currently selected preset library has unsaved changes, the window message "The Preset Library has not been saved. Do you wish to continue?" will appear. To continue importing, click **OK**.

If you want, you can save the changes by clicking **SAVE**.

## Deleting presets from a user library

In addition to storing and loading presets (see "User library (presets)" on page 88), you can delete presets from a preset library.

**>> To delete a preset from a user library**

- 1** In the **Preset Manager** screen, click the preset you want to delete.
- 2** Click **Delete**.
- 3** In the "Are you sure you want to delete this preset?" message window, click **OK**.

## Chapter 25: File Management

This chapter shows you how to import/export your show and preset files.

### About the Files screen

The **Files** screen manages files on the control centre (**Control Surface** panel) and any removable storage device (**Removable Storage** panel) that is currently plugged into one of the USB ports (see “Control surface” on page 235). Each panel lists the files contained on its own storage media. The files can be imported/exported across the panels, and can also be copied, renamed or deleted within their own panel.



Item	Description
------	-------------

- |   |  |
|---|--|
| 1 | Title of show file currently loaded, if any.   |
| 2 | Title of user library preset file currently loaded, if any.  |
| 3 | Memory usage panel. The number on the right shows the total amount of storage space (in MB), or memory, there is on its respective storage media. The green bar on the left shows how much memory has been used. |
| 4 | File lists, display the files on their respective storage media. Each list shows the name, size, creation date and type (for example, show and preset) of each file.   |
| 5 | Information panels give feedback on file management status.  |

<i>Item</i>	<i>Description</i>
<b>6</b>	<b>Removable Storage</b> panel, shows the files currently stored on the storage media (typically, a USB memory key) that is plugged into the active USB socket on the control centre (see "Control surface" on page 235). This panel only appears when the storage media is connected to the control centre, otherwise it is blank. Immediately after plugging in the storage media, you will probably see the message "Analysing...", while its contents are being read.
<b>7</b>	<b>Control Surface</b> panel, shows the files stored on the control centre's SSD.

The following table describes all of the buttons on the **Files** screen.

<i>Button</i>	<i>Function</i>
<b>SAVE</b>	Saves the currently loaded show in its current state. Turns red when there are changes to be saved.
<b>LOAD</b>	Loads the selected show file.
<b>COPY</b>	Copies selected file to its local section, appending "_copy1" to its name. Subsequent copies of the same will file will increment the 'copy' number by one, that is, "_copy2", "_copy3" etc.
<b>RENAME</b>	Lets you to rename the selected file in its local section.
<b>DELETE</b>	Deletes the selected file in its local section.
<b>EXPORT</b>	Copies file selected in <b>Control Surface</b> section to the <b>Removable Storage</b> section, effectively copying it onto the removable device. This provides a useful backup facility.
<b>IMPORT</b>	Copies the file selected in the <b>Removable Storage</b> section to the <b>Control Surface</b> section (PRO2).

## Chapter 26: Using Other Devices With The PRO2

This chapter explains how to use other external devices with the PRO2.

### Using multiple digital consoles

- ! CHANGING THE SYNCHRONISATION CAN RESULT IN LOUD NOISES FROM THE SYSTEM. ALWAYS MUTE THE PA AT THE AMPLIFIER/SPEAKER BEFORE CHANGING THE SYNCHRONISATION SOURCE OR MASTER/SLAVE STATUS.**

You can use an PRO2 together with one or more digital consoles, which can be other Midas digital consoles or indeed any digital console. For example, you can use two PRO2s together in a dual FOH and MON system. To do this the digital consoles must be synchronised. The synchronisation method can be via AES50, AES3 or wordclock. You can even use DL431 Mic Splitters splitters via their AES50 connections.

### Synchronising the consoles

Before you start, choose which Midas digital console you want as master.

For information on external AES50 synchronisation between two Midas digital consoles, see "External AES50 synchronisation" on page 92.

>> To configure system synchronisation at the consoles

- 1 Mute the PA at the amplifier/speaker.
- 2 On the master Midas digital console, configure it by choosing **home ▶ Preferences ▶ General** at the GUI and then clicking the "Master" option (shown right) on the **Configuration** tab.
- 3 Configure a slave Midas digital console by choosing **home ▶ Preferences ▶ General** at the GUI and then selecting the following options:

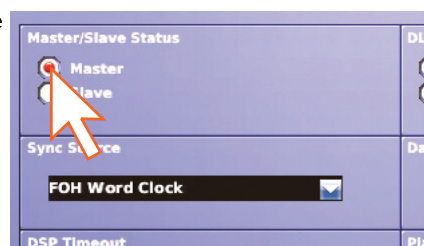

- Under the **Master/Slave Status** heading of the Configuration tab, click the "Slave" option.
- Open the **Sync Source** drop-down list and select the desired synchronisation source.

Repeat for any other Midas digital consoles. Configure any non-Midas digital consoles as appropriate.

## Sharing the A and B inputs of the mic splitter

If you are using two Midas digital consoles, you must configure them to use the A or B inputs of the mic splitters. Although it doesn't matter which inputs each console uses, they can't use the same ones. Also, both consoles must be synchronised.

### >> To configure two PRO2s for use with the mic splitters

In a dual FOH and MON system it may be easier and more convenient to always set the FOH control centre to master, and to use the mic splitter A inputs for FOH and the B inputs for MON. Also, although the sync method doesn't matter in this case, it is easier to sync the two consoles using the DL431 Mic Splitters, as described below.

- 1 **Mute the PA at the amplifier/speaker.**
- 2 Configure the **AES50 Sync** option of the DL431 Mic Splitter's main menu to **Cable Sync A**.
- 3 On the FOH control centre, configure the port that the DL431 Mic Splitter is connected to (see "Device set-up procedure" on page 63).
- 4 Configure the FOH control centre by choosing **home ▶ Preferences ▶ General** at the GUI and then selecting the following options on the **Configuration** tab:
  - Choose the "Use A Inputs" option (shown right).
  - Under the **Master/Slave Status** heading, choose the "Master" option.
- 5 On the MON control centre, configure the port for the DL431 Mic Splitter (see "Device set-up procedure" on page 63).
- 6 Configure the MON control centre by choosing **home ▶ Preferences ▶ General** at the GUI, and then selecting the following options on the **Configuration** tab:
  - Under the **DL431 Mic Splitter Inputs** heading, choose the "Use B Inputs" option.
  - Under the **Master/Slave Status** heading, choose the "Slave" option.
  - In the **Sync Source** drop-down list, choose the port that you configured for the DL431 Mic Splitter in the previous step.

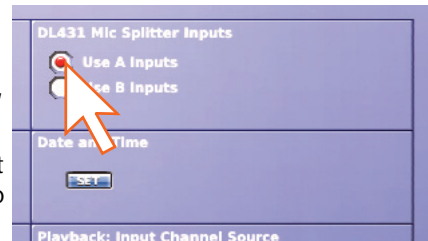

## Using an external USB mouse

You can operate the GUI screen using an external USB mouse instead of its trackball/glide pad. Just plug the mouse into one of the USB sockets on the rear panel of the PRO2. Alternatively, you can plug it into the socket in the **storage** section (to the right of the **population and mute groups** section).

## Using a USB keyboard

You can use a USB keyboard (other than the one supplied). Just plug it onto one of the USB sockets on the rear panel of the PRO2. Alternatively, you can plug it into the socket in the **storage** section (to the right of the **population and mute groups** section).

## Using an external monitor

You can plug a monitor in the DVI socket on the rear panel of the PRO2 for viewing what is shown on any GUI screen.



## Chapter 27: Changing The Preferences

This chapter shows you how to change the user settings of the PRO2 to suit your own preferences and the current working environment.

For information on configuring the number of GEOs and effects, see “Configuring the number of GEOs (and effects)” on page 125.

### Setting the meter preferences

The **Metering** section of the **User** tab provides global parameter adjustment of all of the meters on the control centre.

- **Peak/Hold Time** control knob, sets the time (seconds) the peak LED stays on for, in the range 0 (no peak hold) to infinity (peak always on). This only affects the meters on the GUI. Click the **enable** tick box below to switch on this function.
- **Meter Attack** control knob, adjusts the time it takes the meters to rise, in the range 0 (no delay) to 10 milliseconds. Enable the **pre** option to switch the input channel, aux return and output channel meters to be before the EQ/dynamics/insert. Although the input channels and aux returns are always pre-fader, this option also changes the output channels to pre-fader.
- **Meter Delay** control knob, adjusts the meter delay time, in the range 0 to 0.5 seconds. For example, if the control centre is FOH, this function allows you to synchronise the meters with what you are hearing. This is because the sound from the performers on the stage will take a certain amount of time to reach you, whereas the meters pick up that sound at source. Click the tick box below to select this function. You can adjust the meter delay by using the spin buttons underneath, which display the delay time in milliseconds (ms) and distance in metres (m).
- **Meter Decay** control knob, adjusts the time it takes the meters to fall, in the range 10 to 25 milliseconds.

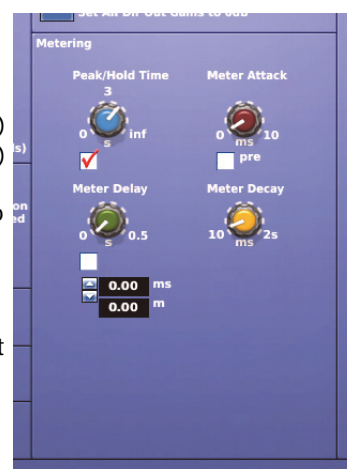

### Configuring a virtual soundcheck

The **Virtual Soundcheck Record** option of the **User** tab lets you set the virtual soundcheck options.

- **All Dir Out Pre-processing** — switches all the direct outputs to pre-processing.
- **Unmute all Dir. Out** — unmutes all direct outputs.
- **Mute all Dir Out** — mutes all direct outputs.
- **Set All Dir Out Gains to 0dB** — sets the gain of all direct outputs to 0dB.

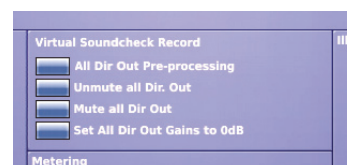

## Configuring playback

The **Playback: Input Channel Source** option of the **Configuration** tab lets you set the record and playback options of a virtual soundcheck.

- Lets you select the input channel source as **Normal** or **Tape Return** via the radio buttons.
- **Enable all Tape Returns** — enables all tape returns.
- **Disable all Tape Returns** — disables all tape returns.

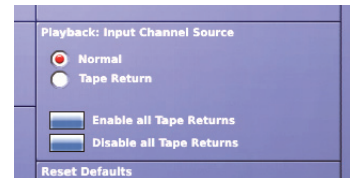

## Restoring the PRO2 defaults

- ! The **Restore Default Preferences** button will reset all console preferences, and must be used with great caution. To alert you of the drastic consequences of operating this button, a **WARNING** window appears.
- ! The **Restore Default Globals** button resets all console defaults, including patching and I/O set-up, and must be used with great caution. To alert you to the drastic consequences of operating this button, a **WARNING** window appears.

You can restore console defaults by using the options in the **Restore Defaults** section of the **Configuration** tab. However, these options must be used with great care.

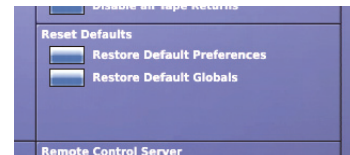

### >> To reset console preferences to default

Open the **Preferences** screen and click **Restore Default Preferences**. Acknowledge the warning window as appropriate.

### >> To reset all console settings to default

Open the **Preferences** screen and click **Restore Default Globals**. Acknowledge the warning window as appropriate.

## Checking the build information

The lower-right corner of the **Configuration** tab is predominantly a service-only feature, and shows the current build and host software versions of the PRO2 Control Centre (typically shown right).

GUI (Compiled) 0.161, (MC) 0.161  
PRO2 V1.15

## Using patching in automation

- ! The **Automate Patching** option switches on per-scene automatic routing, and must be used with caution. To alert you to the drastic consequences of using this option, a **WARNING** window appears.

The **Automate Patching** option of the **Show** tab, when enabled, lets you store patching information in scenes. For information, see “Using patching in automation” on page 171.

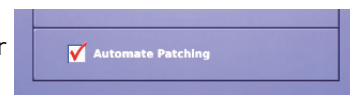

## Selecting the surround mode

The **Surround Mode** section of the **Show** tab lets you select the type of surround mode that the PRO2 uses. For information, see “Selecting the surround mode” on page 209 and “Surround panning” on page 100.

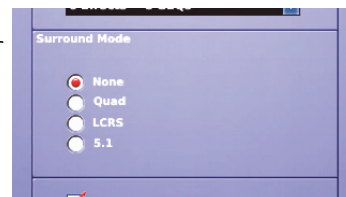

## Setting the time and date

The **Date and Time** section of the **Configuration** tab lets you change the PRO2's time and date.

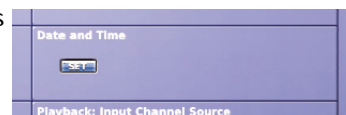

>> To set the time and date of the PRO2

- 1 At a GUI screen, choose **home** ▶ **Preferences** ▶ **General**.
- 2 In the **Date and Time** section of **Configuration Preferences**, click **SET**.
- 3 In the time and date window, enter the time (hours and minutes) and date. Make sure you enter the time correctly, according to the currently configured **Format**, that is, 12-hour (a.m. or p.m.) or 24-hour.
- 4 Click **OK**.



## Setting the user interface preferences

The **User Interface** section of the **User** tab lets you set some of the PRO2's operating parameters to suit your own preferences.

- **Display Rotary Values** — the current value of a control knob can be displayed as a numerical value on the GUI (see “Parameter values displayed on touch” on page 40).
- **Fast Zone Delay Control** — choosing this option means that you place the delay control for the inputs onto the surface controls. To do this you have to cycle the gain **SWAP** button (see “Using gain swap” on page 247) through digital gain, analogue gain and then delay. Without selecting this option, the inputs delay control is a GUI only feature.
- **Select Follow Solo** — when you solo an aux or matrix output, the channel is automatically selected, thus bringing the output controls to the surface detail area. This option only works in fader flip mode.
- **Automate Paging** — choose this option to store channel paging in automation. So that, on scene recall, the control surface (channels assigned to it) will revert to the state it was when the scene was last saved. When unselected, scene recall does not affect channel paging.
- **Fader Touch Navigation of Detail Area** — choose this option to navigate the local detail area on the control surface (right of the GUI screen) to the GUI detail area when one of its touch-sensitive controls is operated.
- **Send Pan Follows Channel Pan** — if a channel is contributing to a stereo mix bus (for example, stereo aux channel), choosing this option will cause the pan for the contribution to mirror that of the channel pan.

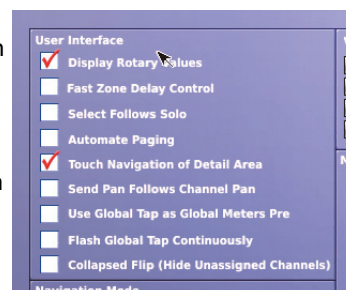

- **Use Global Tap as Global Meters Pre** — choose this option to change the function of the **TAP** button in the **global** section (right of the **advanced mix bay navigation** section) to operate as a global meters pre button (see Meter Attack in “Setting the meter preferences” on page 207).
- **Flash Global Tap Continuously** — choose this option so that the **TAP** button in the **global** section (right of the **advanced mix bay navigation** section) will flash to reflect the current global tap tempo; this value is always displayed (in milliseconds) in the **tap tempo** section at the top of the GUI screen.
- **Collapsed Flip (Hide Unassigned Channels)** — choose this option so that only channels assigned to a mix bus will be visible when flipped to that bus.

## Setting the navigation mode

The **Navigation Mode** section of the **User** tab lets you select one of the three navigation modes of the PRO2.

- **Normal (FOH)** — this default mode sets the control centre to operate using the standard FOH mode of navigation.
- **Normal (Monitors)** — this mode sets the control centre to operate using the standard monitor mode of navigation.
- **Advanced** — this mode sets the control centre to operate using the advanced mode of navigation.

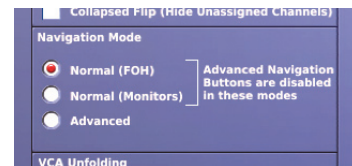

The normal (standard) modes are intended to get you up and running quickly, whereas the advanced mode enables the full power of the console control surface for the more experienced user.

When either of the normal modes is active some of the console functions (and hardware switches) that are intended for the advanced navigation modes are disabled. Additionally, other areas of the console will be set to a default state that avoids preparation prior to use (for example, pre-patched one to one I/O). These are listed in the following table.

<i>Navigation Mode</i>	<i>FLIP</i>	<i>FX</i>	<i>GEQ</i>	<i>MCA</i>
Normal (FOH)	Disabled	Enabled	Disabled	Disabled
Normal (Monitors)	Enabled	Enabled	Disabled	Disabled
Advanced	Enabled	Enabled	Enabled	Enabled

### Normal mode (FOH and monitors)

When the safe scene is recalled and the console is configured in either **Normal (FOH)** or **Normal (Monitors)** mode, the following default settings are applied.

- DL251 configured on ports 1, 2 and 3
- DL251 inputs patched to mic inputs 1-48
- First four POPulation groups are pre-populated with:
  - Mic inputs 1-16
  - Mic inputs 17-32
  - Mic inputs 33-48
  - Mic inputs 49-56 and aux returns 1-8
- The fifth POPulation group is pre-populated with:

- Aux sends 1-16 and matrices 1-8 (PRO2 only)
- Aux Sends 1-16 (PRO2c only)
- The sixth POPulation group is pre-populated with:
  - Matrices 1-8 (PRO2c only)
- FX 1-3 are pre-loaded with DN780 Reverb effects
- FX 4 is pre-loaded with a Pitch Shifter effect
- FX 1-4 stereo outputs are patched to aux returns 1-8

### Normal (FOH) mode

In addition to the common normal mode settings (above), the following settings are applied in **Normal (FOH)** mode.

- Matrix outputs 1-4 are configured as mono sends and patched to FX 1-4
- Aux send outputs 1-8 are patched to DL251 outputs 1-8
- Matrix outputs 1-5 are patched to DL251 outputs 9-13
- Master L, R and C outputs are patched to DL251 outputs 14-16
- All input and aux return channels are routed to the stereo masters
- Aux send 9-16 are configured as stereo groups and routed to the stereo masters

### Normal (Monitors) mode

In addition to the common normal mode settings (above), the following settings are applied in **Normal (Monitors)** mode.

- Aux sends 1-16 are patched to DL251 outputs 1-16
- All input and aux return channels are routed to all aux sends with pre-fade set to ON and send level set to OFF

## VCA unfolding

The **VCA Unfolding** section of the **User** tab lets you select **Overlay Stereo Pairs** to unfold only left channels of channel pairs when a VCA group is selected. Use the navigation buttons to display any desired right channel.

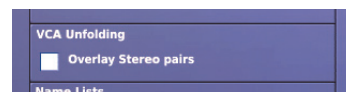

## Changing the default input/output names

The **Name Lists** section of the **User** tab lets you change the names that appear in the lists on the **Input Sheet** and **Output Sheet**. These lists provide you with a number of default names from which you can choose when naming your inputs and outputs in the GUI menu.

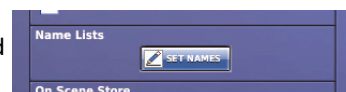

>> **To change the set names in the Input/Output Sheets**

- 1 At the GUI, choose **home** ▶ **Preferences** ▶ **General**.
- 2 In the **Names Lists** section of **User Interface Preferences**, click **SET NAMES**.

- 3 In the **Set Name Lists** window (shown right), click within the field containing the name you want to change. Enter the new name (see “Text editing” on page 42).

Repeat for any other names you want to change.

- 4 Click **CLOSE**.



## On-scene store

The **On Scene Store** section of the **User** tab lets you choose whether or not parameters protected by a channel safe will be written to a scene when the scene is stored (see “Overriding store scope” on page 170).

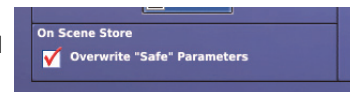

## Changing the signal processing preferences

The **DSP Timeout** section of the **Configuration** tab lets you set the amount of time (between 10 and 600 seconds) the DSPs will continue to run after an update is received from the control surface, before the audio is muted.

The **inf.** tick box is for selecting infinity, which will allow audio to continue indefinitely if power to the control surface is lost.

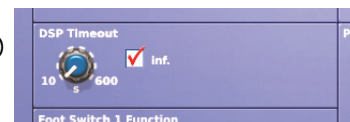

## Adjusting PRO2 illumination

The **Illumination** section of the **User** tab lets you adjust the brightness and contrast of the GUI screen, the brightness of the LEDs (including meters) on the control surface and the brightness of the lamp.

To increase/decrease the brightness of the GUI screen or lamp, click the desired up/down spin buttons.

To increase/decrease the brightness of the solo LEDs, meter LEDs or the other LEDs on the control surface, use drag to adjust the appropriate control knob (from **off** to **full**).



## Selecting the function of the foot switch(es)

On the **Configuration** tab you can select the foot switch function as either of the following:

- **Next Scene** Choose this option to go to the next scene when the foot switch is operated.
- **Tap Tempo** Choose this option to use the foot switch to set the tempo.





## Selecting the fan speed

In the **Fan Speed** section of the **Configuration** tab you can select the speed of the internal cooling fan of the PRO2 Control Centre according to the operating conditions. If you are operating the PRO2 in a warm or hot environment we recommend that you select the **Fast** option. If the noise of the fan operation is causing a problem, select the **Slow** option.

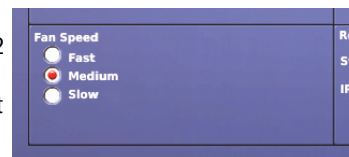

## Remote control server

In the **Remote Control Server** section of the **Configuration** tab, you can enable remote control of the console by the Midas software for Apple iPad. To do this carry out the following:



- 1 Connect your console to a secure wireless network.
- 2 Do one of the following:
  - Enter an appropriate IP address for your network using the up/down spin buttons of the **IP Addr.** section\*
  - Tick the **DHCP** box so that your router automatically assigns an IP address to your network\*\*
- 3 Click **Start**. The server will take several seconds to start up. Once up and running, the status will confirm the IP address.

You can stop the server at any time by clicking **Stop**. This will disable external control of the console.

### Important:

**We recommend that you do not connect the console to an unsecured or public network, as other users could potentially take control of the console.**

\* Avoid using addresses in the range 192.168.20.x, as they are reserved for console internal communication. Netmask is predefined as 255.255.255.0.

\*\* In DHCP mode, if the address you are assigned is in the range 169.254.x.x this indicates the console could not find a DHCP server (and the server will not function). Check connections and consult the manufacturer's instructions for your router.

## Configuring the channels, groups and internal units

You can change the default name and colour of the input and output channels, groups, internal rack units and GEOs of the PRO2 that appear on the control surface (LCD select buttons) and GUI. This is done via the 'Sheet' screen of each item, which is accessible via the GUI menu.

The procedure for configuring the VCA/POPulation groups is shown in "Configuring VCA/POPulation groups" on page 75, and this is principally the same for each of the above items.





## Chapter 28: Delay Compensation (Latency)

A time delay is induced in a channel's signal by placing, for example, an insert or GEQ in its path. This delay affects system latency and can also produce undesirable audio effects. To overcome this the PRO2 incorporates a system of user-configurable delay compensation parameters. These are presented to the user in the form of button-selectable options on the GUI and can be switched on or off to suit the current application.

### Insert compensation

If a channel insert is active, it takes a finite amount of time for the signal to be sent through an internal or external effect and returned to the channel. Therefore, with no insert compensation, channels with inserts assigned are delayed more than channels that don't have an insert assigned to them. If two correlated signals with different delays are mixed together, this can produce comb filtering.

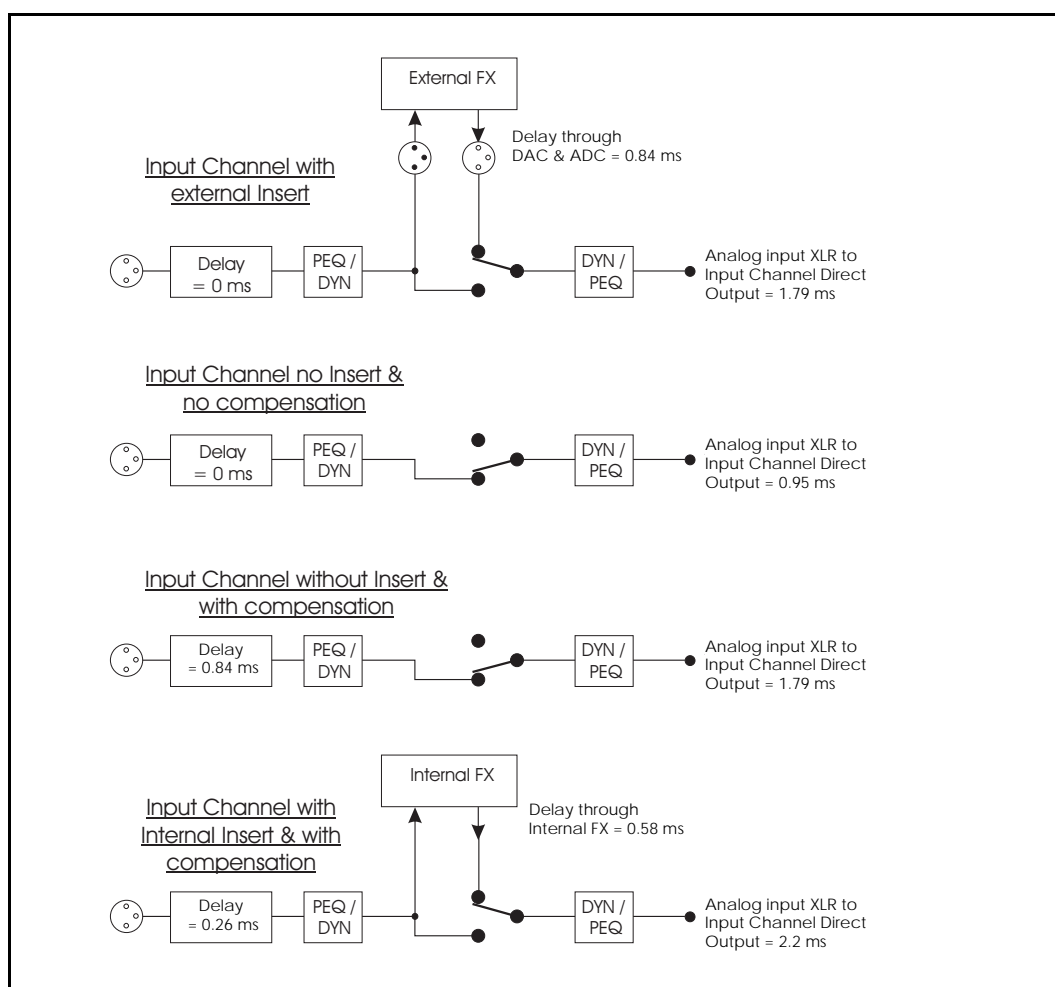

Figure 17: Input channel insert compensation

To avoid the comb filtering effect, the PRO2 insert compensation works by delaying all channels except the ones that have inserts assigned. In practice, the actual delay used for compensation depends on the type of insert (internal/external) and its location (stage/FOH). Each channel type or layer within the console, such as, input, aux, master or matrix, has its own parameter controlling the delay compensation for that layer. This provides the user with the maximum flexibility and allows the console to be configured for the lowest latency for a given application.

## GEO compensation

Output bus channels have the ability to have a GEO inserted into them, which incurs an additional delay in their signal path. With GEO compensation active, a delay is inserted into the output buses, which is removed when a GEO becomes active. This ensures that all bus outputs of the same type are aligned regardless of whether they use a GEO or not.

## GUI Delay Compensation options

PRO2 delay compensation (latency) is configured in the **Delay Compensation** section (shown right) of the **Delay Compensation** screen.

For a description of the delay compensation options and details of when best to use them, see Table 11 (below). In this table the **Description** column explains what happens when the delay compensation option is selected (switched on) and the **Latency (ms)** column shows the value that the overall system latency is increased by.

### >> To access the delay compensation options

At the GUI, choose **home ▶ Preferences ▶ General** and click the **Delay Compensation** tab to open the **Preferences Delay** screen.

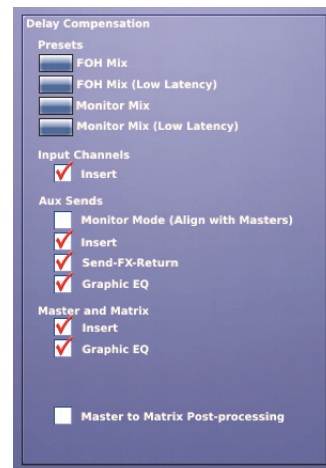

**Table 11: Delay compensation options**

<b>Section</b>	<b>Option</b>	<b>Description</b>	<b>Recommendations</b>	<b>Latency (ms)</b>
Input Channels	Insert	Time-aligns the output of all input channels, regardless of whether or not they have an active insert. When this option is switched off, any input channels with inserts will be delayed relative to those input channels that do not have inserts.	If no inserts are used in the input channel layer, switch this option off to reduce the overall system latency.  If there is an insert on any input channel, switch this option on.	0.84
Aux Sends	Monitor Mode (Align with Masters)	See "Monitor Mode (Align with Masters)" on page 218.	N/A	N/A

<i>Section</i>	<i>Option</i>	<i>Description</i>	<i>Recommendations</i>	<i>Latency (ms)</i>
	Insert	Compensates for inserts placed in aux buses. To do this it modifies the delay that sits between the input channel outputs and master/matrix channel inputs, so that signals fed from inputs to masters will line up with signals fed from inputs through auxes to masters.	<p>If there are no inserts on any aux channels, switch this option off to reduce overall system latency.</p> <p>If any aux channel has an insert, switch this option on.</p> <p>If the <b>Monitor Mode (Align with Masters)</b> option is selected, switch this option off.</p>	0.84
	Send-FX-Return	This option compensates the inputs to master and matrix paths for the signal path between an aux through an effect, and back through a return to the master and matrix channels.	<p>If no effects are used between the aux and return channels, switch this option off to reduce overall system latency.</p> <p>If any effects are used between any auxes and returns, switch this option on.</p> <p>If the <b>Monitor Mode (Align with Masters)</b> option is selected, switch this option off.</p>	0.84
	Graphic EQ	This setting controls the delay compensation aligning aux bus outputs for channels that use GEQ with those that do not.	<p>If no aux buses use GEQ, switch this option off to reduce overall system latency.</p> <p>If any aux bus has a GEQ inserted, switch this option on to ensure all aux bus outputs are time-aligned.</p>	0.5
Master and Matrix	Insert	Time-aligns the output of all the master and matrix channels, regardless of whether or not they have an active insert. With this option switched off, the outputs of any master or matrix channels using inserts will be delayed relative to the equivalent channels not using them.	<p>If no inserts are used in the master/matrix channel layer, switch this option off to reduce overall system latency.</p> <p>If Inserts are used in any master/matrix channels, switch this option on.</p>	0.84
	Graphic EQ	This option controls the delay compensation that aligns master and matrix bus outputs for channels using GEQ with those that do not.	<p>If no master or matrix buses are using GEQ, switch this option off to reduce overall system latency.</p> <p>If any master or matrix buses have a GEQ inserted, switch this option on to time-align all master and matrix bus outputs.</p>	0.5

## Monitor Mode (Align with Masters)

The default console bus structure is organised such that inputs can be routed to masters, and also simultaneously routed to masters and matrix channels via aux buses (see Figure 19 “Routing via aux buses”) or via aux and return buses (see Figure 18 “Routing via aux and return buses”), while maintaining the same overall input to output latency in both paths.

This may not be the desired structure if auxes and matrix outputs are both being used for monitor mixes, where it is desirable for auxes, masters and matrix outputs to be time-aligned with the minimum possible latency.

With this option switched off, the delay element that is used to delay the paths from input channels to master/matrix channels is removed. With all insert and GEOQ delay compensation switched off, the latency between a system input XLR and a system output XLR is being fed by an aux, master or matrix channel is 1.79ms (see Figure 20 “Latency for input to aux, master and matrix outputs”).

If using this option, it is advisable to use the same GEO and insert compensation settings for aux and master/matrix channels to maintain their identical output latency.

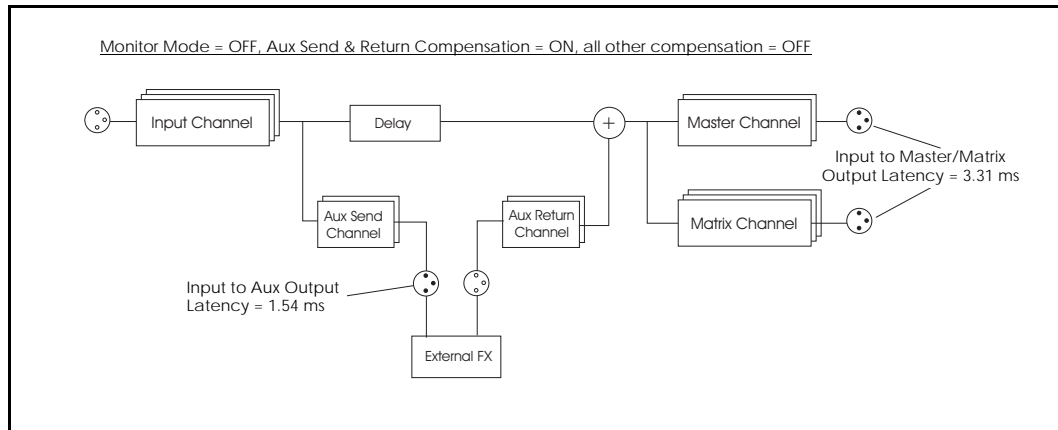

Figure 18: Routing via aux and return buses

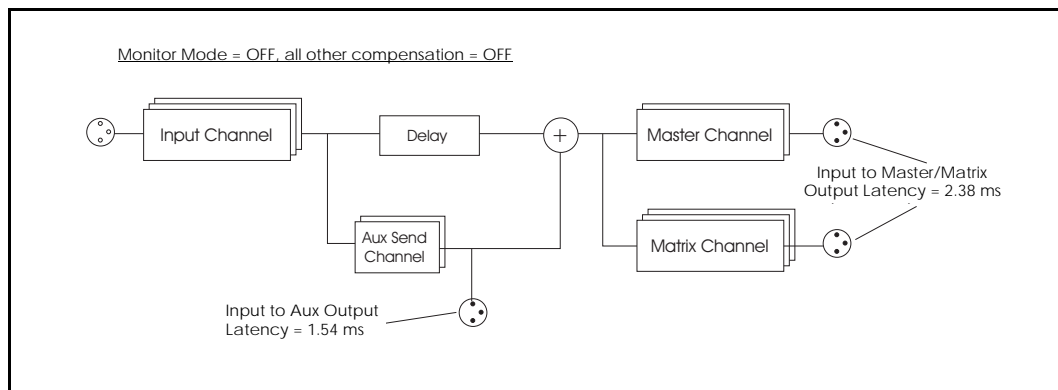

Figure 19: Routing via aux buses

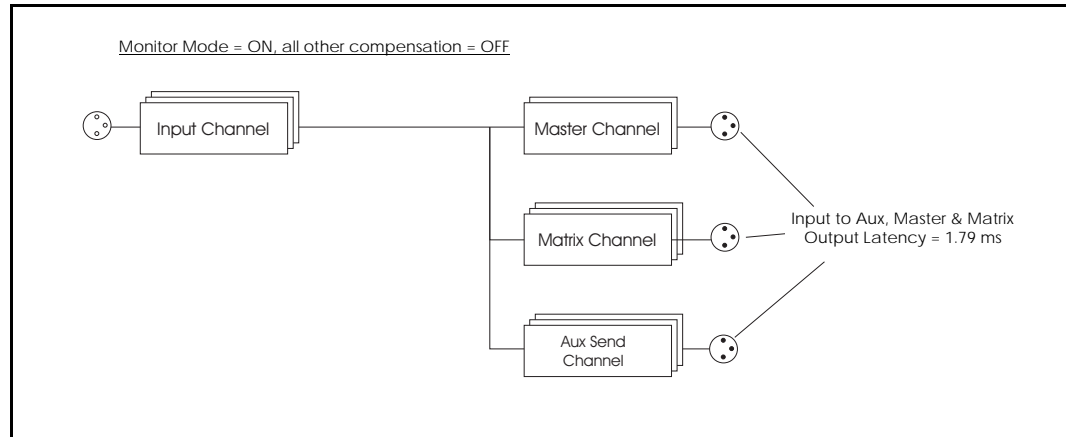

Figure 20: Latency for input to aux, master and matrix outputs

## Zones

The PRO2 system can be divided into conceptual 'zones', as follows:

- **System Input Zone:** DL251 Audio System I/O or surface analogue/AES3 inputs, which are normally routed to Input channels. These inputs are *primary* system inputs and the console output latency is measured relative to these inputs.
- **Mix Zone:** Aux outputs, return inputs and master/matrix direct inputs, which can be freely patched to and from internal or external effects, while maintaining output signal alignment.
- **Output Zone:** System outputs, that is, master and matrix outputs when **Monitor Mode (Align with Masters)** compensation is switched off, or aux, master and matrix outputs when **Monitor Mode (Align with Masters)** compensation is switched on.

Aux direct inputs are fixed to the System Input Zone so that DL251/DL431/DL451 inputs routed to an aux direct input will automatically line up with inputs routed to auxes via input channels.

Return inputs and master and matrix direct inputs can be configured to operate in either the System Input Zone (for example, as additional console inputs) or the Mix Zone (for example, as effect returns) and are configurable on a per channel basis.

Examples of patches using the Mix Zone that are all fully compensated when the **Send-FX-Return** option of the **Aux Sends** section of the delay compensation is switched on are:

- Aux -> Internal/External Effect -> Return
- Aux -> Internal/External Effect -> Master Direct Input
- Aux -> Internal/External Effect -> Matrix Direct Input
- Aux with Insert -> Internal/External Effect -> Return

Input channel direct outputs are simply a copy of the input channel output or mic input signal, depending on the direct output mode for a particular channel. It is not possible to delay these signals to line-up with the main system outputs or aux outputs, so patching from a direct output to an effect and back in to a return, master direct input etc., cannot be fully compensated for.

The input to direct output latency depends on the direct output mode and the **Inserts** option of the **Input Channel insert** delay compensation status according to the following table.

<i>Direct Output mode</i>	<i>Input channel insert compensation (ms)</i>	
	<i>Off</i>	<i>On</i>
Pre-processing	0.59	0.59
Post-processing	0.948	1.78

## Masters to matrix tap-off point

The signal path that feeds master bus signals onto matrix channels is fully compensated for so that signals fed direct to matrix channels or indirectly to matrix channels via master channels will always line up at the outputs, as will signals sent only to masters or only to matrix channels.

The user is given the choice of tap-off point, so they may choose to send either a pre-master or post-master channel processed signal to the matrix channels. This is a global setting and affects all master -> matrix contributions, as shown in the following diagram.

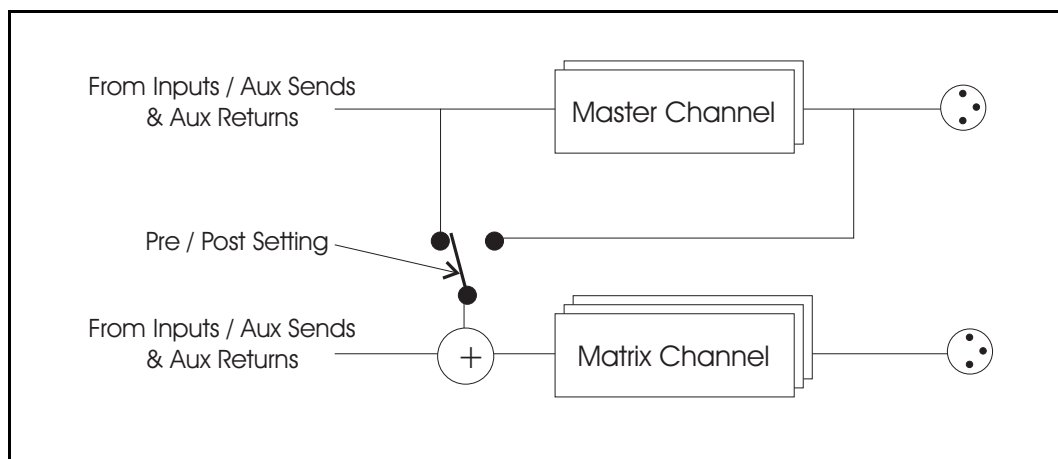

Figure 21: Master and matrix tap-off points

Sending pre-processed master bus signals to matrix channels reduces the overall system latency. If post-processed tap-off points are used, the system must compensate for both the latency of the matrix and master channels, and if insert and GEQ compensation are both required on master and matrix channels, this can push the maximum system latency up to 8.49 ms. With no other insert or GEQ compensation switched on, using post-processed tap-off points produces a system latency of 2.72 ms, as opposed to pre-processing tap-off points, which would produce a latency of 2.38 ms. When **Monitor Mode (Align with Masters)** is switched on, these figures are 1.79 ms and 2.14 ms, respectively.

## Typical configurations

Here are some actual examples of typical configurations to illustrate the effects of delay compensation. Please note the following:

- All XLRs are located at stage end, unless FOH is stated.
- INS can mean an internal effect or an external effect with analogue, or AES3 I/O at either FOH or stage position.
- Abbreviations are: IP = input channel; AS = aux (send) channel, AR = (aux) return channel; AR (Input) = (aux) return channel set to input mode; MAST = master channel; MTX = matrix channel; DI (mix) = direct input set to Mix Zone (DI can be either pre- or post-); and DI (input) = direct input set to System Input Zone (DI can be either pre- or post-).

### FOH Mix Setup

The following table shows the delay compensation settings for this mix.

<i>Option</i>	<i>On/off status</i>
<b>Master to Matrix Post-processing</b>	On
<b>Input Channels</b>	
<b>Insert</b>	On
<b>Aux Sends</b>	
<b>Monitor Mode (Align with Masters)</b>	Off
<b>Insert</b>	On
<b>Send-FX-Return</b>	On
<b>Graphic EQ</b>	On
<b>Master and Matrix</b>	
<b>Insert</b>	On
<b>Graphic EQ</b>	On

The following example signal paths all measure the same latency of 815 samples @ 96kHz = 8.49 ms:

- FOH XLR – IP – MAST – XLR
- XLR – IP – MAST – XLR
- XLR – IP – MTX – XLR
- XLR – IP – AS - MAST – XLR
- XLR – IP – AS – INS – MAST – XLR
- XLR – IP (With INS) – AS (With INS) – INS – AR – MAST (With INS) - XLR
- XLR – IP (With INS) – AS (With INS + GEQ) – INS – AR – MAST (With INS + GEQ) - XLR
- XLR – IP – AS – INS – MAST DI (Mix)
- XLR – IP – AS – INS – MTX DI (Mix)
- XLR – MAST DI (Input)
- XLR – MTX DI (Input)
- XLR – AS DI – MAST – XLR
- XLR – AR (Input) – MAST – XLR
- XLR – IP – MAST – MTX
- XLR – IP – AS (With GEQ) – MAST (With GEQ)

- XLR – IP – AS (With GEO) – MTX (With GEO)

### FOH Mix Low Latency

The following table shows the delay compensation settings for this mix.

<i>Option</i>	<i>On/off status</i>
<b>Master to Matrix Post-processing</b>	Off
<b>Input Channels</b>	
<b>Insert</b>	Off
<b>Aux Sends</b>	
<b>Monitor Mode (Align with Masters)</b>	Off
<b>Insert</b>	Off
<b>Send-FX-Return</b>	On
<b>Graphic EQ</b>	Off
<b>Master and Matrix</b>	
<b>Insert</b>	Off
<b>Graphic EQ</b>	On

The following example signal paths all measure the same latency of 366 samples @ 96kHz = 3.81 ms:

- FOH XLR – IP – MAST – XLR
- XLR – IP – MAST – XLR
- XLR – IP – MTX – XLR
- XLR – IP – AS - MAST – XLR
- XLR – IP – AS – INS – MAST – XLR
- XLR – IP – AS – INS – MAST (With GEO) – XLR
- XLR – IP – AS – INS – MAST DI (Mix)
- XLR – IP – AS – INS – MTX DI (Mix)
- XLR – MAST DI (Input)
- XLR – MTX DI (Input)
- XLR – AS DI – MAST – XLR
- XLR – AR (Input) – MAST – XLR
- XLR – IP – MAST – MTX
- XLR – IP – AS – MAST (With GEO)
- XLR – IP – AS – MTX (With GEO)



**Monitor Mix**

The following table shows the delay compensation settings for this mix.

<i>Option</i>	<i>On/off status</i>
<b>Master to Matrix Post-processing</b>	Off
<b>Input Channels</b>	
<b>Insert</b>	Off
<b>Aux Sends</b>	
<b>Monitor Mode (Align with Masters)</b>	On
<b>Insert</b>	On
<b>Send-FX-Return</b>	Off
<b>Graphic EQ</b>	On
<b>Master and Matrix</b>	
<b>Insert</b>	On
<b>Graphic EQ</b>	On

The following example signal paths all measure the same latency of 300 samples @ 96kHz = 3.125 ms:

- FOH XLR – IP – MAST – XLR
- XLR – IP – MAST – XLR
- XLR – IP – MTX – XLR
- XLR – IP – MAST- MTX – XLR
- XLR – IP – AS – XLR
- XLR – IP – AS (With GEO) – XLR
- XLR – AS DI – AS – XLR
- XLR – AS DI – AS (With GEO) – XLR
- XLR – AR (Input) – MAST – XLR
- XLR – AR (Input) – MAST (With GEO) – XLR
- XLR – AR (Input) – MTX (With GEO) – XLR
- XLR – AR (Input) – MAST - MTX - XLR
- XLR – AR (Input) – MAST - MTX (With GEO) - XLR

**Monitor Mix (Low Latency)**

The following table shows the delay compensation settings for this mix.

<i>Option</i>	<i>On/off status</i>
<b>Master to Matrix Post-processing</b>	Off
<b>Input Channels</b>	
<b>Insert</b>	Off
<b>Aux Sends</b>	
<b>Monitor Mode (Align with Masters)</b>	On
<b>Insert</b>	Off
<b>Send-FX-Return</b>	Off
<b>Graphic EQ</b>	Off
<b>Master and Matrix</b>	
<b>Insert</b>	Off
<b>Graphic EQ</b>	Off

Input Ch Insert (OFF)

Aux Insert (OFF)

Aux Send & Return (OFF)

Aux GEQ (OFF)

Masters / Matrix Insert (OFF)

Masters / Matrix GEQ (OFF)

Master to Matrix tap-off = pre-processing.

Aux alignment (OFF)

The following example signal paths all measure the same latency of 172 samples @ 96kHz = 1.79 ms:

- FOH XLR – IP – MAST – XLR
- XLR – IP – MAST – XLR
- XLR – IP – MTX – XLR
- XLR – IP – MAST- MTX – XLR
- XLR – IP – AS – XLR
- XLR – AS DI – AS – XLR
- XLR – AR (Input) – MAST – XLR
- XLR – AR (Input) – MAST - MTX - XLR

# *Description*



## Chapter 29: Panel Connections

This chapter describes the rear and front panels of the PRO2.

### Rear panel connections

The rear panel has two main areas.

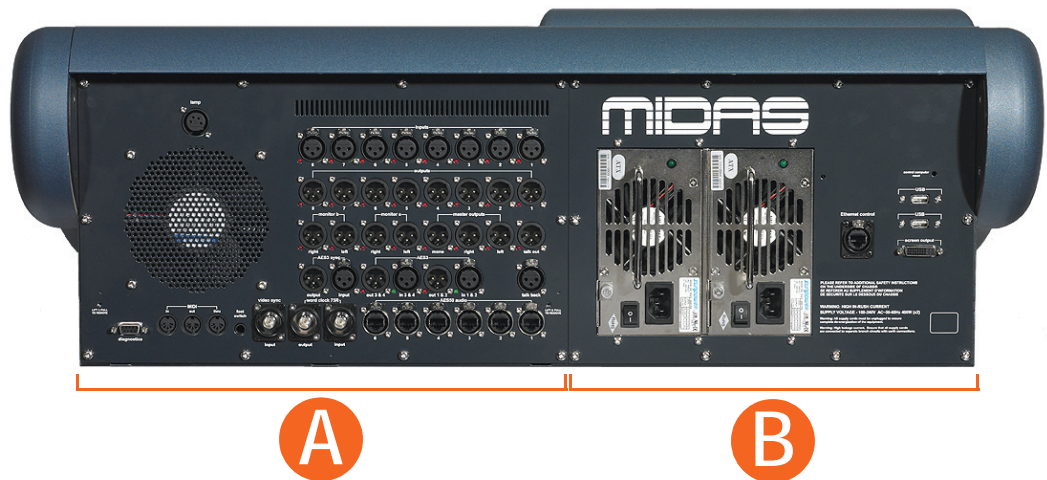

## Connectors in area A

Area A houses the connectors for audio, networking, synchronising, etc.

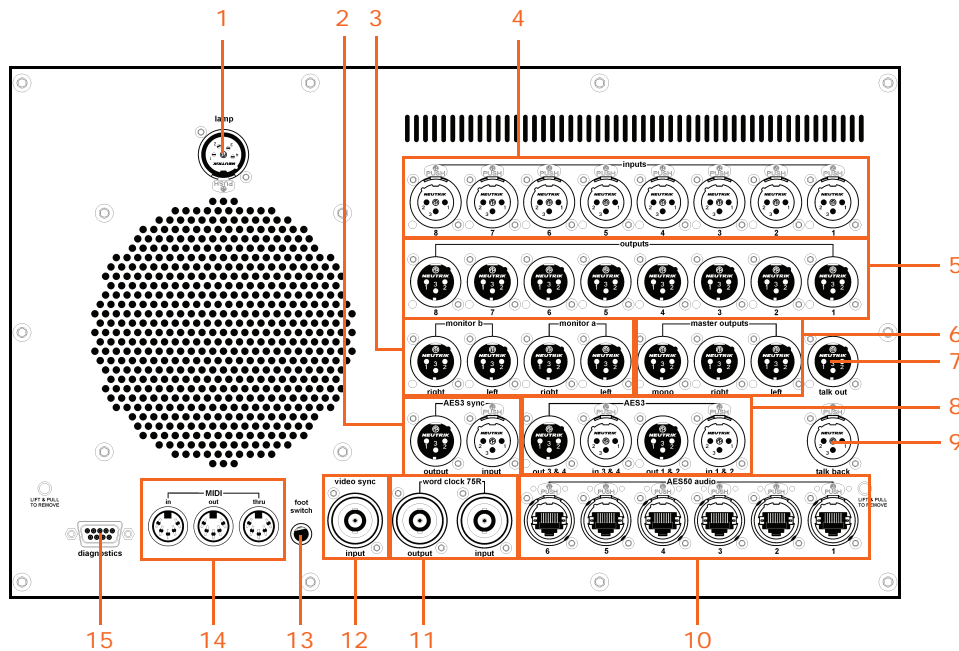

External connections on the left rear panel of the control centre

Item	Description
1	Lamp connector (see "Other connections" on page 29).
2	AES3 sync connectors (see "AES3 sync" on page 229).
3	Monitor a and b connectors (see "Monitor a and b outputs" on page 229).
4	Input connectors (see "Inputs" on page 229).
5	Output connectors (see "Outputs" on page 230).
6	Master outputs (see "Master outputs" on page 230).
7	Talk out connector (see "Talk out" on page 230).
8	AES3 inputs and outputs (see "AES3" on page 231).
9	Talk back connector (see "Talk out" on page 230).
10	AES50 audio connectors (see "AES50 audio" on page 231).
11	Word clock connectors (see "Word clock" on page 232).
12	Video sync connector (see "Video sync" on page 232).
13	Foot switch connector (see "Other connections" on page 29).
14	MIDI connectors (see "MIDI" on page 232).
15	Diagnostics connector. <b>This is for service personnel use only.</b>

**AES3 sync**

**input** and **output** connectors for synchronisation with external devices that can transmit/receive a 96kHz AES3 signal.

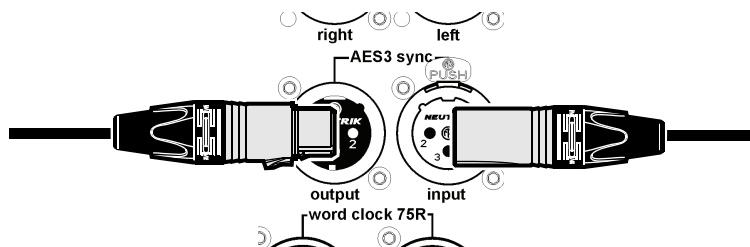

**Monitor a and b outputs**

There are two monitor output sections (**monitor a** and **monitor b**) for the monitor A and B sections, and both have **right** and **left** connectors.

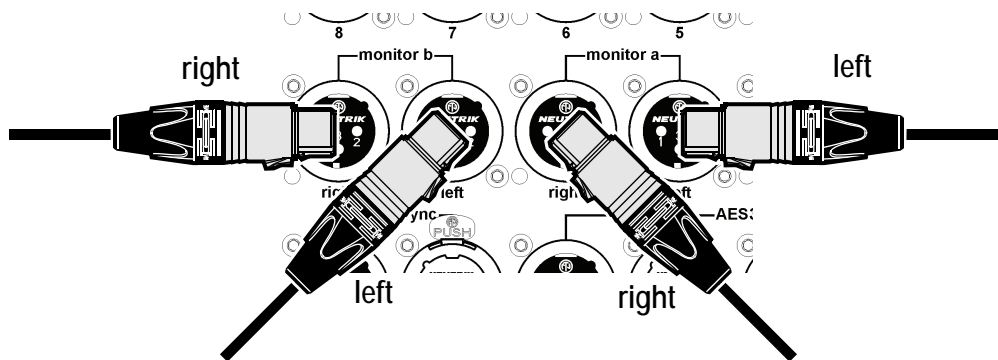

**Inputs**

The **inputs** section has eight input connectors for XLR mic/line inputs.

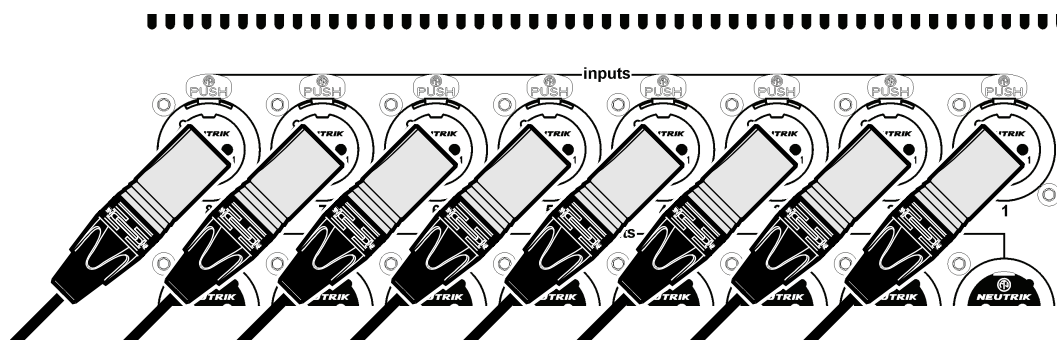

**Outputs**

The **outputs** section has eight output connectors for XLR analogue outputs.

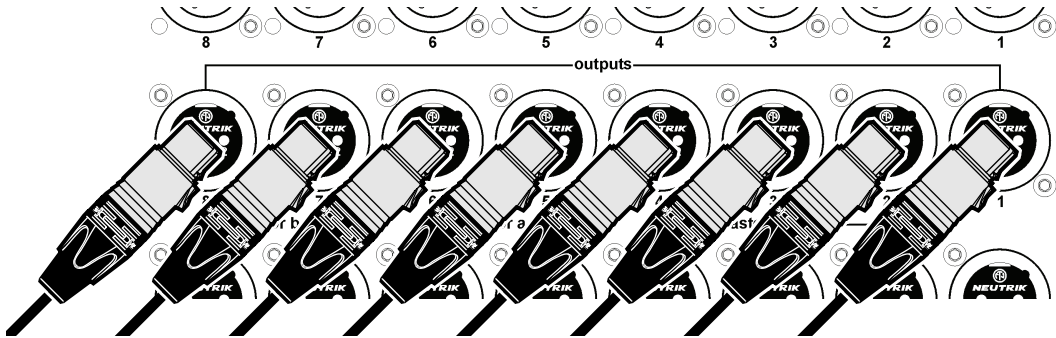

**Master outputs**

The **master outputs** section has a **mono** and **left** and **right** output connectors for XLR analogue outputs.

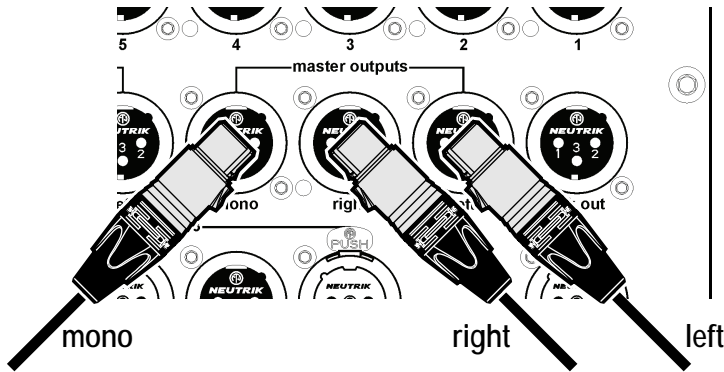

**Talk out**

The **talk out** output connector for a male output XLR.

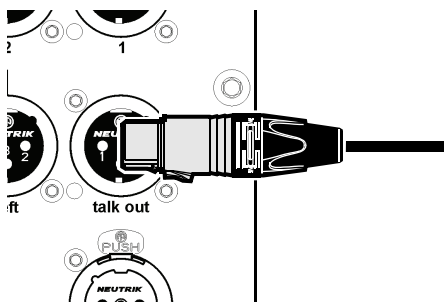



**AES3**

The **AES3** section has two pairs of **input** and **output** connectors for synchronisation with external devices that can transmit/receive a 96kHz AES3 signal.

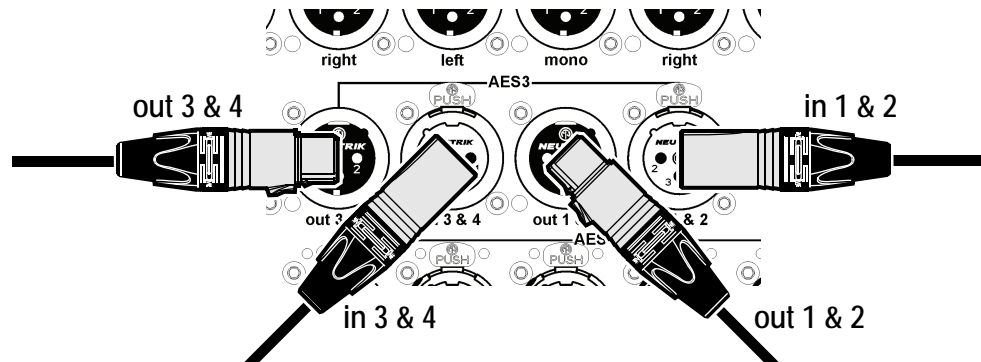

**Talk back**

The **talk back** input connector accepts a female input XLR.

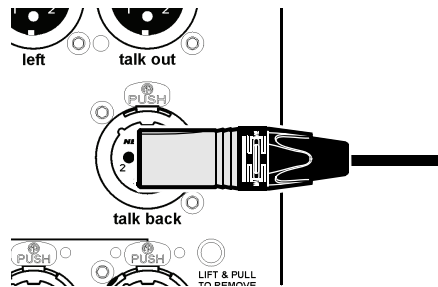

**AES50 audio**

Six AES50, 24-wide, bi-directional digital audio EtherCon® ports.

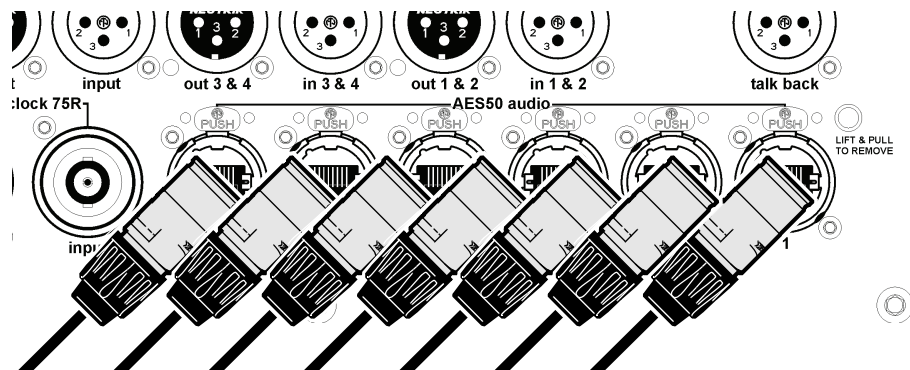

**Word clock**

The **word clock 75R** section comprises **input** and **output** BNC cable sockets for synchronisation with external devices that can transmit/receive a 96kHz word clock signal.

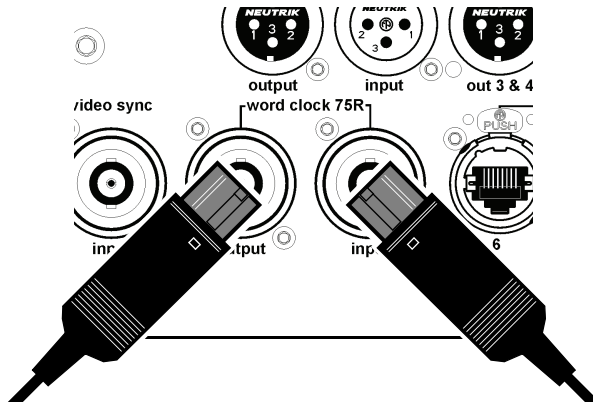

**Video sync**

The **video sync** port has an **input** BNC cable socket for synchronisation with a video device.

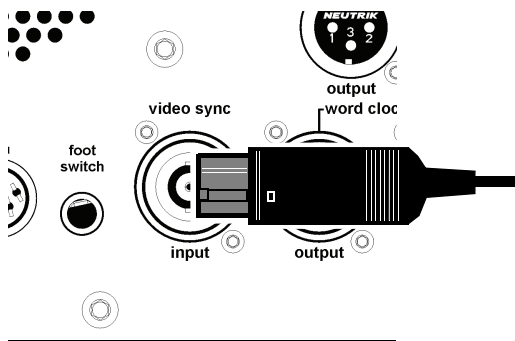

**MIDI**

The **MIDI** section has **in**, **out** and **thru** sockets that each accepts a 5-pin DIN connector.

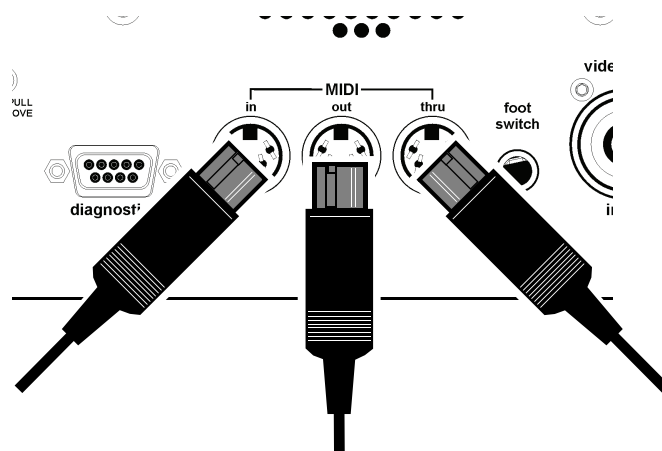

## Connectors in area B

Area B houses the connectors for mains power, USB devices, external monitor, etc.

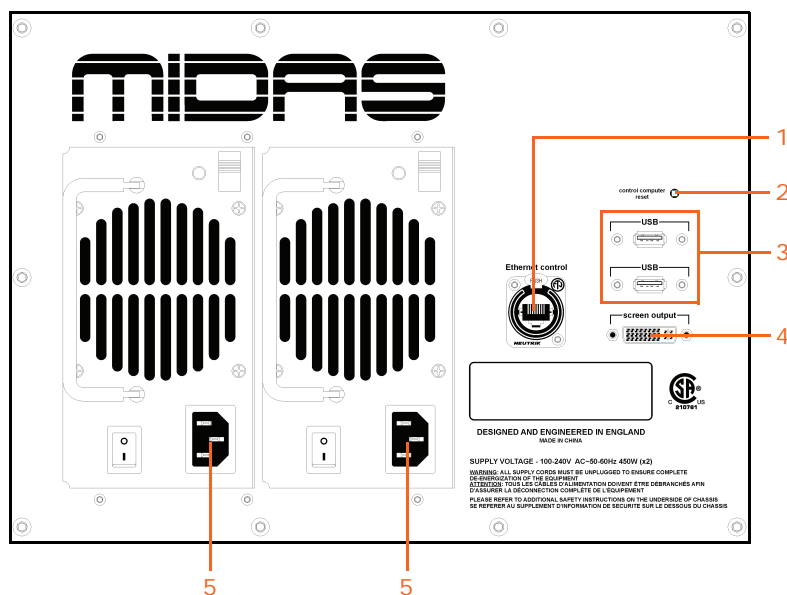

External connections on the right rear panel of the control centre

Item	Description
1	Ethernet control connector (see "Ethernet control" below).
2	<b>control computer reset button. This recessed button is for service personnel use only.</b>
3	USB connectors (see "USBs" below).
4	Screen output connector (see "Screen output" on page 234).
5	Mains input connectors (see "Mains power connectors" on page 234).

**Ethernet control**

A 100Mb/s **Ethernet control** port (on EtherCon®) lets you connect equipment, such as the Klark Teknik DN9331 Rapide Graphic Controller.

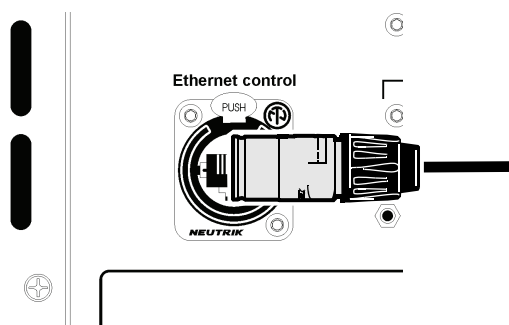

**USBs**

Two USB ports let you connect USB-enabled devices, such as external keyboards, external mice, etc.

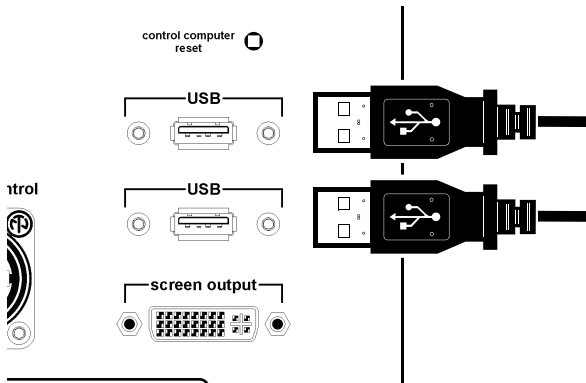

**Screen output**

A DVI **screen output** port lets you connect an external monitor so that you can view remotely what is shown on the GUI screen.

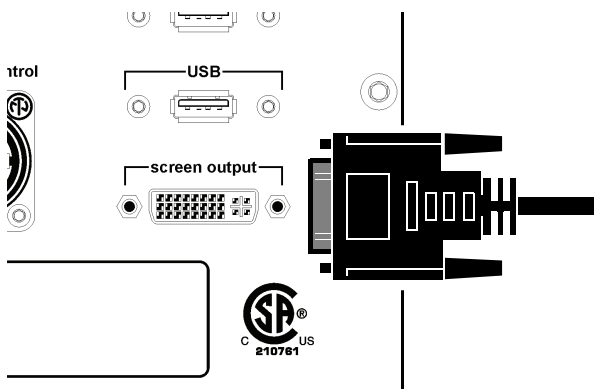

**Mains power connectors**

Dual redundant power supplies each accept a mains IEC connector. **Both power supplies must be connected to separate mains outlets.**

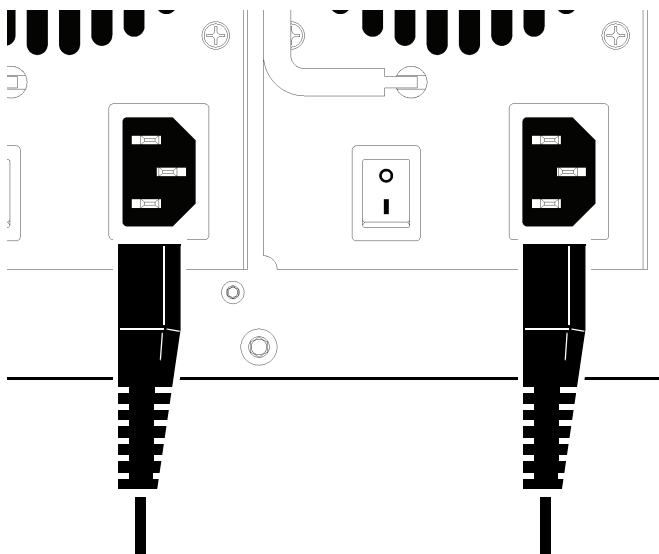

## Control surface

The PRO2 has a rear connector panel that caters for the connection of mains power leads, 19" rack unit(s), USB memory keys, keyboards, headphones, talk mics, communications, external monitor, AES3 synchronisation, diagnostics (for service personnel only), lamp and word clocks (75R).

The control surface houses a USB connector for uploading/downloading show files and updating the system software, and a connector for a talk mic.



*Talk mic connector and storage USB connector on the control surface*

For more information, see Chapter 29 "Panel Connections" on page 227.

There are two similar connector panels at the front of the PRO2 Control Centre, which are situated at either end under the armrest as shown in the following diagram.



## Chapter 30: Input Channels

By default, all of the input channels are mono, although any two adjacent channels (odd left and even right) can be linked to form a stereo pair. The order of processing in the signal path of both channel types is basically the same.

The order of the descriptive sections in this chapter loosely follows the signal path taken by the input channels. However, this varies according to signal processing order and the operation of certain controls.

### Input channel routing

The diagram right shows the default signal path, on which the structure of this chapter is based. This chapter will explain each of these groups of controls, showing the pertinent controls on both the control surface and GUI.

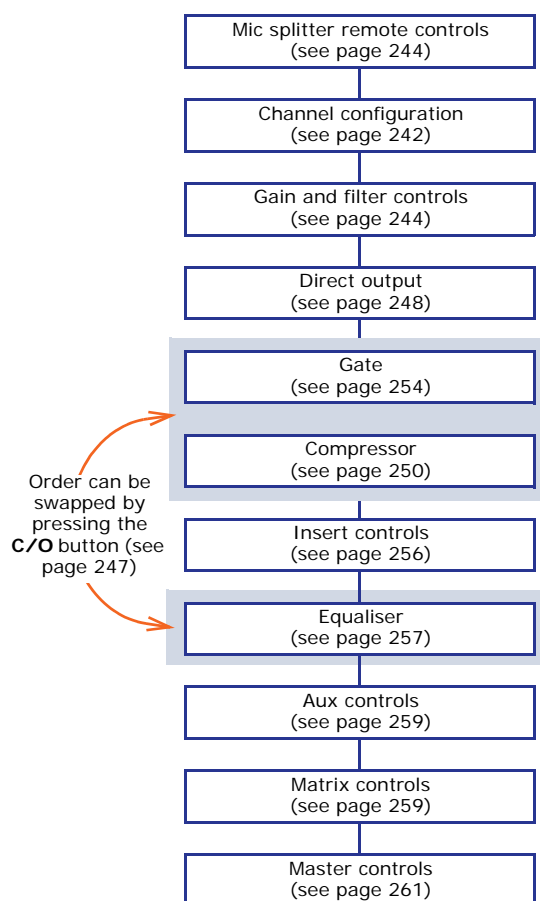

### Input channel areas

The input channels are assigned to the channel bay faders. However, by using the **EXTEND** button in the **channel faders** section (see the PRO2 Live Audio System Quick Start Guide for details) the mix bay faders can be used as well. Detail adjustment of the input channels is augmented by the channel detail areas. The GUI provides extensive input channel support and also provides extra functionality.

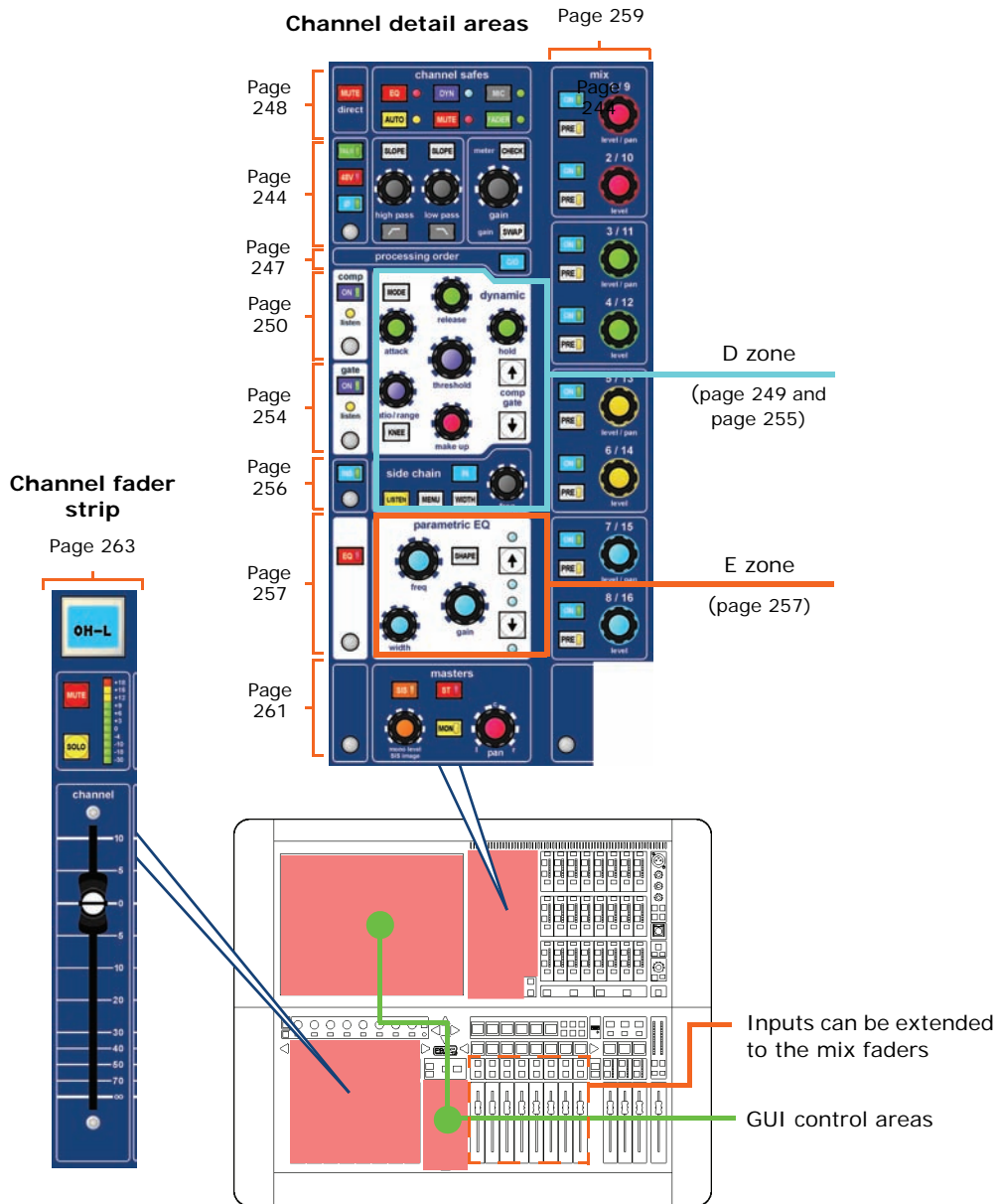

Areas on the control surface concerned with input channels



## Inputs on the GUI

The GUI replicates the channel faders by displaying the eight channels currently assigned to them. When an input channel is selected the GUI's channel strip displays the channel's **input channel overview**. From this display, you can access detail areas by clicking within specific sections (avoiding any controls).

For details of how to operate the GUI, see Chapter 6 "Working With The PRO2 Control Centre".

### GUI input fast strips

The input fast strips on the GUI (a typical example is shown right) give an overview of their equivalent versions on the control surface.

The **gain trim** section changes its appearance to suit the type of control that has been 'swapped' to it (see "Using gain swap" on page 247).

Some detail areas are configuration dependent, such as the bus sends (depends on surround configuration) and console gain/digital trim.

The appearance of the console gain/digital trim section (also for channel detail area, see "GUI channel strips" on page 239) depends on whether or not a signal source is patched to the input channel and the nature of that source, and the current status of the Gain Swap parameter.

Due to the free-routing nature of the console's architecture, it is possible that any given input to a signal chain can be sourced from a variety of devices that have various remote-controlled mic amps. However, the GUI will offer the correct controls according to the source that has been routed.

### GUI channel strips

When an input channel is selected, its overview appears in the channel strip. This is called the "input channel overview" (see Figure 22, "Detail areas available from the input channel overview display," on page 240) and provides limited controls and status information. Clicking a non-control area within a specific section will open that section's detail area, which contains the full set of controls. The following detail areas are available, which are shown in Figure 22 "Detail areas available from the input channel overview display" on page 240:

- Configuration (direct out, safes and gain trim - channel ID, channel source, filters, linking, swap, delay and processing order)
- Compressor
- Gate
- EQ
- Inserts
- Mix buses

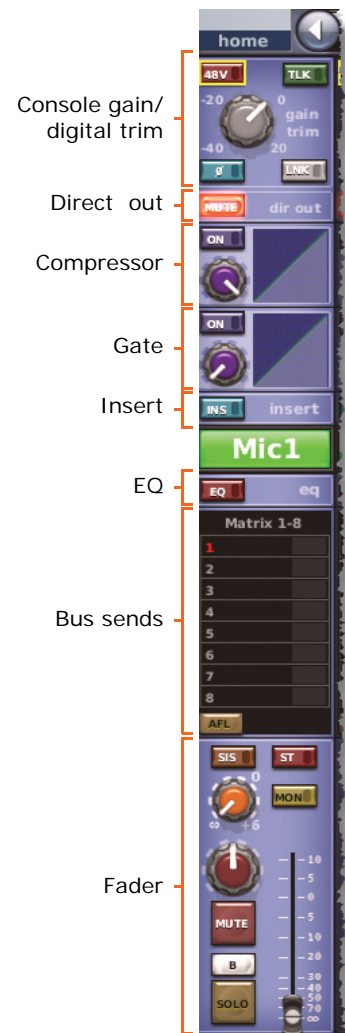

- Masters (faders, solo, panning etc.)

For details of how to navigate the GUI channel strip, see “About GUI navigation” on page 46.

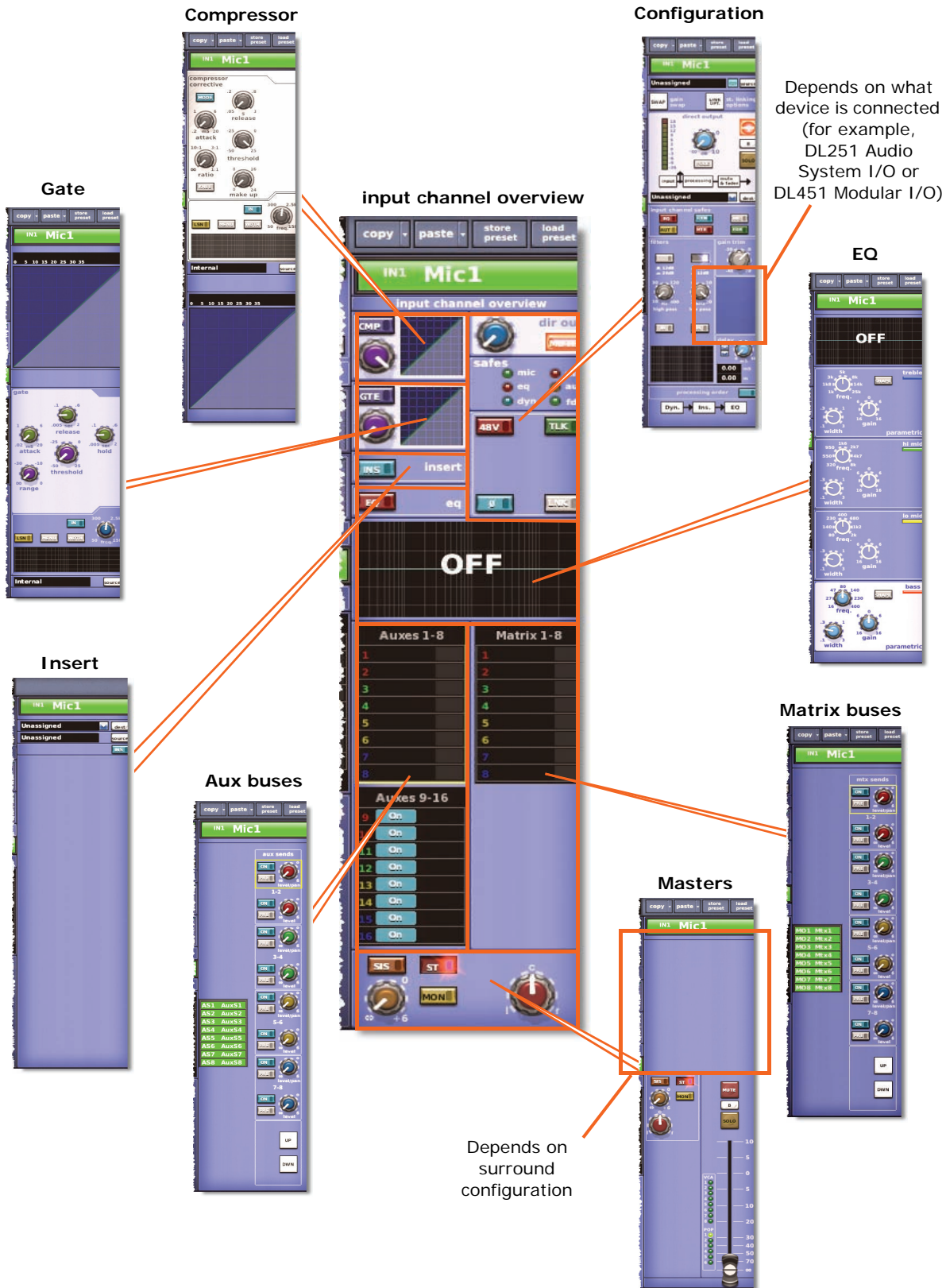
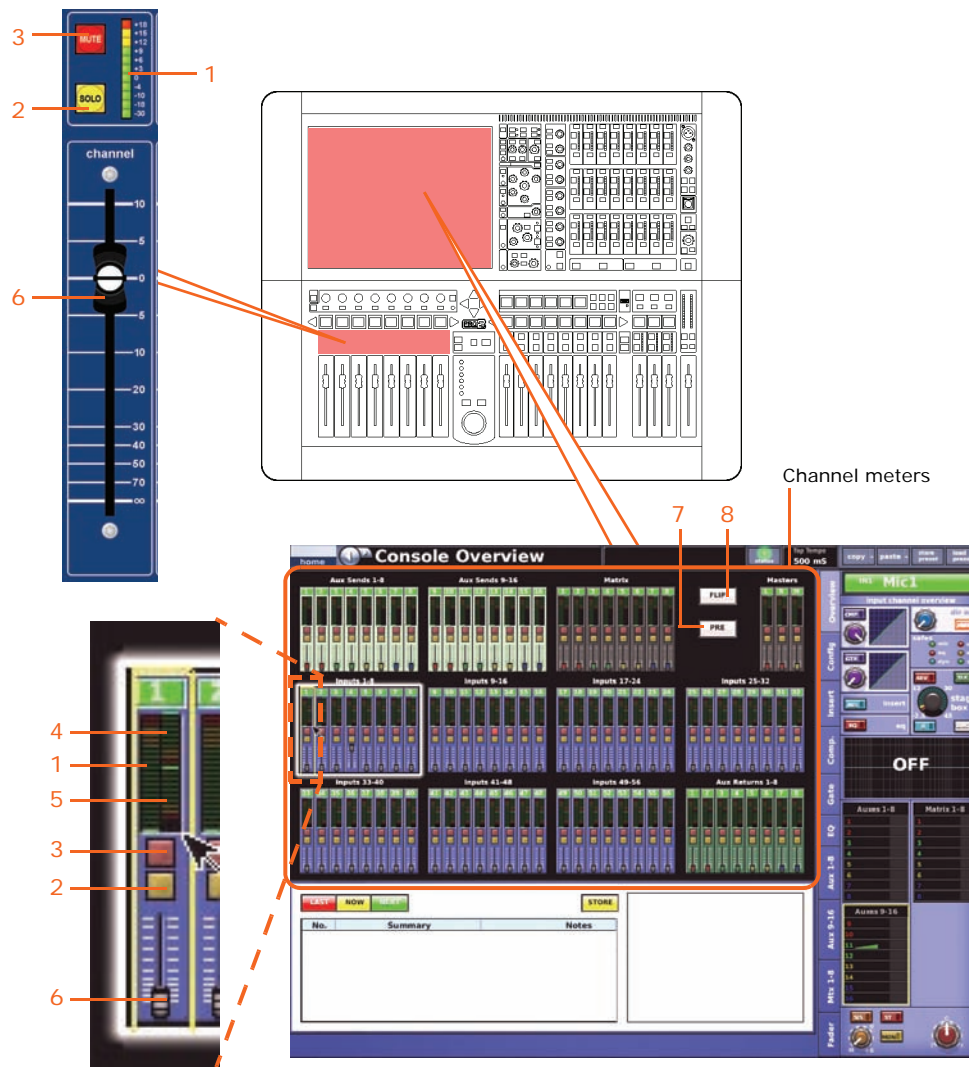

Figure 22: Detail areas available from the *input channel overview* display

## Input metering

The **Console Overview** screen shows all of the meters all of the time. Meters can be switched globally to monitor the raw A/D input point, and are also individually switchable using the meter **CHECK** button in the **gain** section (see “Mic amp input gain (preliminary input processing)” on page 244).



Item	Description
1	11-segment meter for showing the input channel level
2	<b>SOLO</b> switch for switching the input channel's solo on/off
3	<b>MUTE</b> switch for muting the input channel
4	LED meter for showing the gain reduction when using a compressor
5	LED meter for showing the gain reduction when using a gate
6	Input channel fader
7	<b>PRE</b> switch, which is a global meter switch that switches all inputs to monitor the raw A/D input point.
8	<b>FLIP</b> switch for enabling flip mode.

## Channel configuration controls

There are a number of input channel controls that are loosely termed 'channel configuration' controls. These comprise:

- **Input channel ID (GUI only):** name and identification. Both the name and colour of the name field are user-configurable. For details, see "Input channel ID (GUI only)" on page 243.
- **Input channel source (GUI only):** shows where the input is routed (patched) from, that is, the physical location the input channel is getting its audio from, and provides direct access to the **Patching** screen. For details, see "Input channel source select (GUI only)" on page 243.
- **Gain swap:** swaps what the rotary gain is controlling from remote (stage box) gain to digital trim (console gain), and vice versa. For details, see "Mic amp input gain (preliminary input processing)" on page 244.
- **Stereo linking:** links adjacent channel for stereo operation. For details, see "Stereo linking (GUI only)" on page 243.
- **Input channel direct output:** routes signal path from a selected point to an I/O. For details, see "Direct output" on page 248.
- **Input channel safes:** switches that protect specific controls from being changed by the automation system. For details, see "Safes" on page 244.
- **Gain and filter:** mic amp gain and filter controls.
- **Inserts:** allows configuration of the send and return points when an insert is used.
- **Input channel delay (GUI only):** user-defined delay to be added to the input signal processing. For details, see "Input channel delay (GUI only)" on page 243.
- **Processing order:** selects whether the EQ or the dynamics comes first in an input channel's signal path.

Their control is divided between control surface and the GUI, although some are GUI only. All of them are in the configuration detail area, with the exception of the inserts, which have their own detail area (see Figure 22 "Detail areas available from the input channel overview display" on page 240).

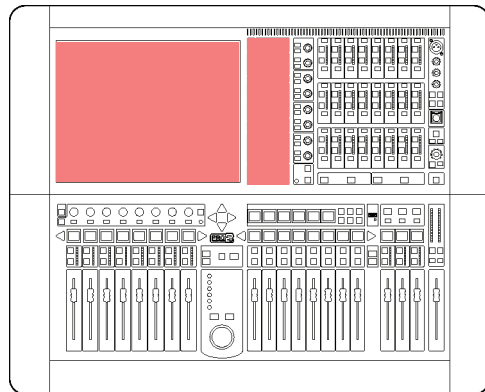

### Input channel ID (GUI only)

You can change the channel name via the GUI, which can be done directly in the input channel overview or in any of the detail areas (see "Text editing" on page 42).



To change the background colour of the input channel name field (default is green), open the **Naming Sheet** screen of the GUI menu.

### Input channel source select (GUI only)

The channel's source is shown in the text field; if none has been selected, it will contain the text "Unassigned" (as shown right). You can select the source for this channel by clicking **source**, which opens the **Patching** screen (see Chapter

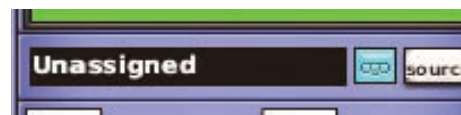

8 "Patching" on page 47). Also, by clicking the recorder button  you can set the input source to tape returns to obtain an alternative input, for example, from a hard disk recorder for a virtual soundcheck.

### Input channel delay (GUI only)

The input channel delay can only be changed via the **delay** section of the configuration detail area (GUI channel strip). This section has a control knob for adjusting the delay in the range 0ms to 50ms; this value is displayed in both milliseconds (ms) and metres. You can fine tune the delay value using the spin buttons to the left of the control knob.



The **delay** section allows you to incorporate a time delay on an input channel, which is used mainly for mic placements and time aligning to reduce comb filtering. For example, on a drum kit mic set up, you may have a mic close to a snare drum and a couple of overhead mics. In this case, setting an input channel delay on the snare drum — to bring it more in line with the overheads — will probably produce a better sound.

### Stereo linking (GUI only)

The linking/gain swap section of the configuration detail has a **LINK OPT.** button that opens a **Stereo Linking Options** window from where you can choose which parameters you want to link between the pair.

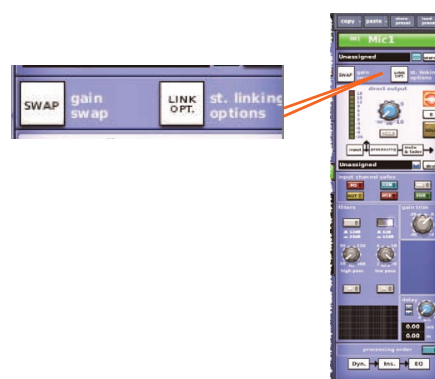

For more information, see Chapter 10 "Stereo Linking" on page 95.



## Safes

Each input channel has six different safes that protect specific controls/areas from the automation system.

You can switch the safes on/off by using the buttons in the **channel safes** section of the channel strips or via those in the **input channel safes** section on the GUI, which also illuminate when they are on.

For more information on what areas are protected by each safe, see Appendix H "Parameters Protected By Safes" on page 385.

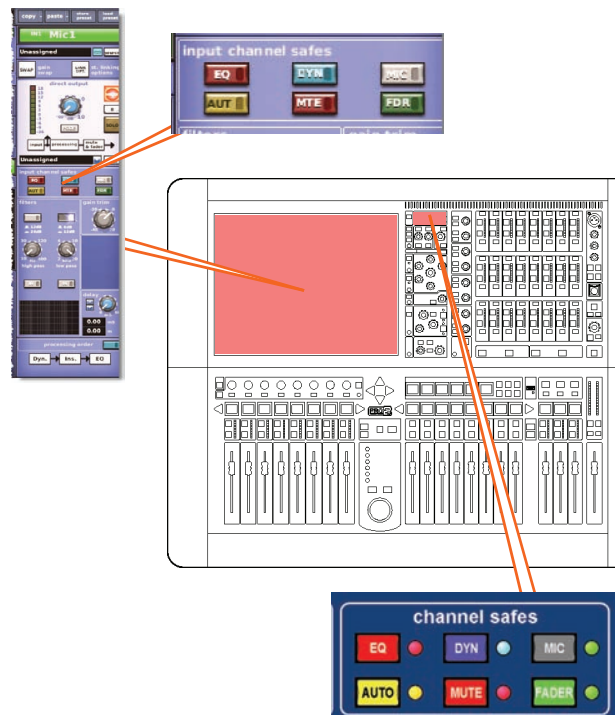

## Mic amp input gain (preliminary input processing)

There are two types of mic input channel controls: digital and remote. Most of the controls are digital, which directly affect the parameters stored within the DSP. However, a few controls can also be thought of as remote controls, which control the physical components of the mic splitters and even components that are in the signal path before it enters the digital domain.

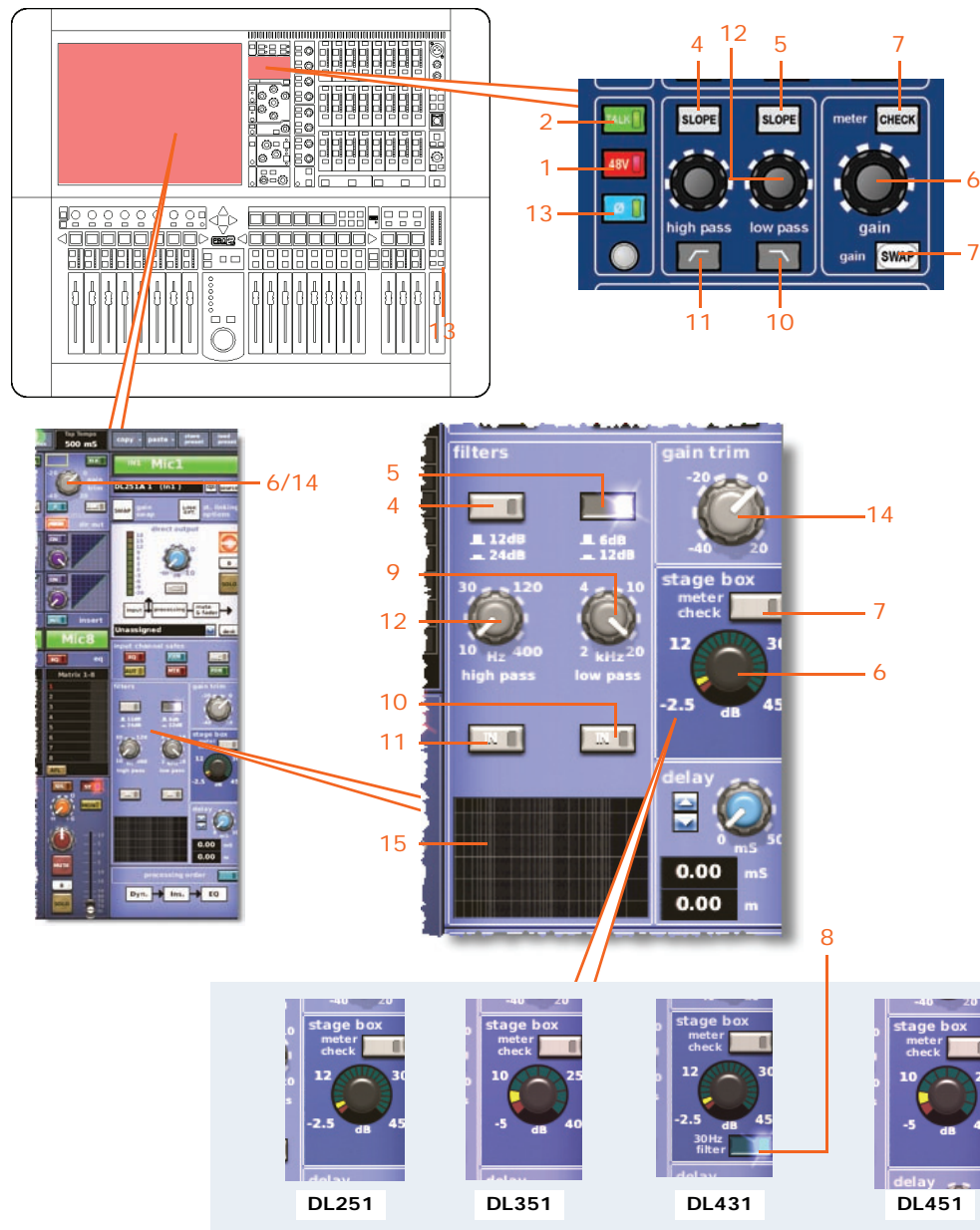

The remote controls are dependent on the types of devices connected to the PRO2. For example, the analogue input module (DL441) has a 48V phantom voltage button and a gain control. The controls are adjusted via the device's configuration window (see "Configuring the devices" on page 60).

By default, console digital trim is adjusted by the gain trim control knob in each input fast strip and the remote gain control is adjusted by the stage box control knob in the input channel strip. However, by pressing the gain swap button these functions are swapped over, so that the gain trim control knob now controls the remote gain, and the stage box control knob controls the digital trim. Pressing gain swap again reverts them to default. As the legends of these two control knobs on the control surface are permanently fixed, their current 'swap' status can only be determined by the illumination of the **SWAP** button and what is shown for these controls on the GUI.



Mic amp input gain on the control surface and GUI

Item	Control	Function
1	<b>48V</b> switch (stage box only)	Connects 48 volts of phantom power to the XLR mic input channel connector. Suitable for a condenser microphone or DI box.
2	<b>TALK</b> switch	Connects talk mic and/or tone and noise generators to the input channel.
3	Gain swap button	See "Using gain swap" on page 247.
4	<b>SLOPE</b> switch (digital trim only)	Selects the value of the <b>high pass</b> filter. Where, switch on (illuminated) = 24dB slope and switch off (extinguished) = 12dB slope.

<i>Item</i>	<i>Control</i>	<i>Function</i>
5	<b>SLOPE</b> switch (digital trim only)	Selects the <b>low pass</b> filter. Where, switch on (illuminated) = 12dB slope and switch off = 6dB slope.
6	<b>stage box</b> control knob	Adjusts the input gain of the remote amplifier in 5dB steps, ranging from -5dB to +40dB. Note that the <b>stage box</b> control knob on the control surface will only adjust the gain currently selected to the GUI input channel strip, that is, stage box or digital trim.
7	<b>CHECK</b> switch (stage box only)	Monitors the mic amp input after the 30Hz filter, but before any further processing. (The 30Hz subsonic filter switch accesses the high pass filter on DL431 Mic Splitter when connected to a PRO2. In this case, the gain steps would be 2.5dB from -2.5dB to +45dB.)
8	<b>30Hz</b> subsonic filter switch	Acts on remote amplifier (mic splitter) to remove very low frequencies in the audio signal — usually caused by noise on stage. This avoids wasting valuable headroom trying to digitise it.
9	<b>low pass</b> control knob (digital trim only)	Adjusts frequency of low pass filter in the range 2kHz to 20kHz.
10	Low pass filter switch  /[IN] (digital trim only)	Activates low pass filter in the input channel signal path before the insert points and EQ.
11	High pass filter switch  /[IN] (digital trim only)	Activates high pass filter in the input channel signal path before the insert points and EQ.
12	<b>high pass</b> control knob (digital trim only)	Adjusts frequency of high pass filter in the range 10Hz to 400Hz.
13	Phase switch $\emptyset$	Applies a 180° inversion of the input signal polarity within the input amplifier, such that channel signal will have opposite polarity to the input signal.  This is used to correct input signal phase problems when trying to sum signals that are 180° out of phase. For example, where two mics are facing each other when using a mic on both the top and bottom of a snare drum. Ordinarily, the two mics would be out of phase - causing cancellation when the control centre sums the two signals into the output. Reversing the phase of one signal causes the mics to have the same phase, thus avoiding cancellation.
14	Gain trim (digital trim) control knob	Applies continuous trim adjustment (small digital steps) of the input signal level in the range -40dB to +20dB. Gives a further 60dB of fine adjustment (DSP) on top of the remote amplifier gain setting. This control knob on the input fast strips can be controlling stage box gain, digital trim or delay, depending on the current state of the swap.
15	Graph	Shows the effects of currently applied filter.



**Using gain swap**

Operating the gain **SWAP** button, swaps the function of the gain control (top of input fast strips) between that of the digital trim and stage box gain. In addition, if the **Fast Zone Delay Control** option (see "Setting the user interface preferences" on page 209) is enabled, input delay is also included in the swap.



*Always check the GUI for 'swap' status.*

**Processing order**

This section has a **C/O** switch that changes order of processing from EQ/INS/DYN (default) to DYN/INS/EQ and vice versa, which is shown in the GUI channel strip.

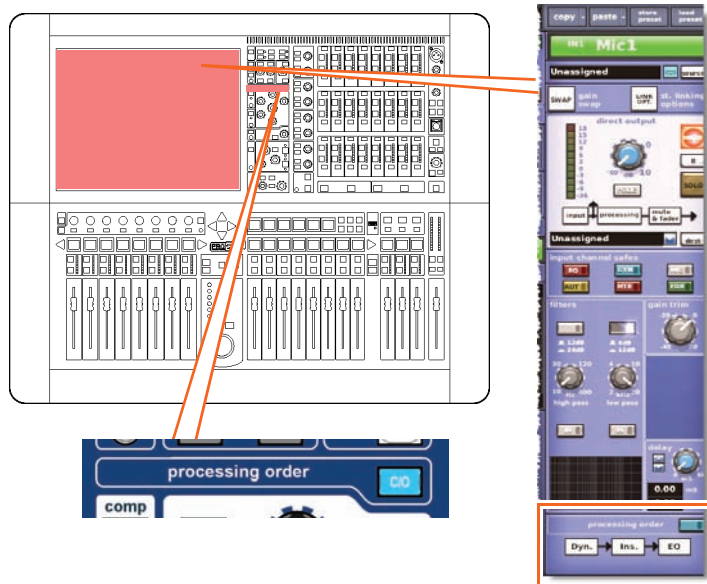

## Direct output

The direct output section lets you to take a signal directly out of a defined point in the input channel's signal path and route it to either an internal assignable effect or a physical output (a physical connection at one of the line I/O boxes). This function is optional and assigned on a channel-by-channel basis.

This section is deliberately distanced from the main channel panel controls because it is a limited resource and unused on many channels.

Selection of signal path position (item 4) and destination (item 5) can only be carried out via the GUI.

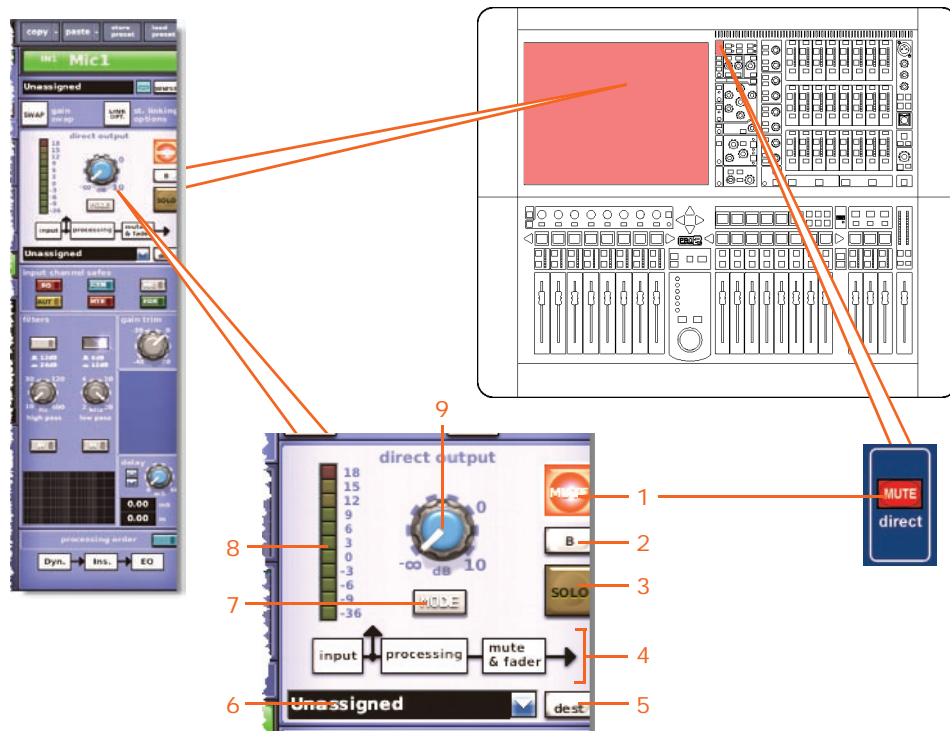

Item	Description	Function
1	<b>MUTE</b> switch	Mutes any assigned direct output by removing signal from the output. However, it will not operate (will remain illuminated) if nothing is assigned. It is included in the scene recall system but is not affected by the channel mute safe or the auto-mute masters (unless the source tap-off point is after the main channel mute).
2	<b>B</b> switch	Changes the operation of the <b>SOLO</b> switch so that it routes signals to the monitor B section of the control centre.
3	<b>SOLO</b> switch	Activates signal routing to the Monitor A (or if the B switch is illuminated, Monitor B) section of the control centre.
4	Tap-off point diagram	Shows where the direct output is sourced from in the signal path, as selected by the mode button (see item 7).
5	<b>dest</b> button	Opens the <b>Patching</b> screen so that you can select the destination of the direct output.

<i>Item</i>	<i>Description</i>	<i>Function</i>
6	Direct output drop-down list	Displays the destination(s) of the direct output. For example, to an O/B vehicle, while simultaneously going into a DN9696.
7	<b>MODE</b> button	Changes the source tap-off point for the signal. There are three options: post-fader and mute; pre-mute and post-processing; or pre-mute and pre-processing. This function is not used if the direct output is not unassigned to channel.
8	11-LED meter,	Monitors the direct output level in the range +18dB to -36dB.
9	Control knob	Adjusts direct output level. Range is infinity ( $\infty$ ) to 10dB.

## Dynamics (D zone)

The **dynamic** section — or D zone — controls two dynamic devices present in the input channel signal path, that is, the compressor and gate. While most D zone controls are shared between the two dynamic devices, some are device-specific. The GUI treats both devices independently, the detail area of the one currently displayed in the channel strip being the one currently selected to the D zone. Swapping between the two dynamic devices can be done by clicking in the compressor/gate areas of an input fast strip, by pressing the input or gate quick access buttons, or the up/down select buttons in the D zone itself when the input channel strip is in use.

Activating the dynamic device's **ON** button activates the device, but also affects the audio.

By default the source for the compressor's sidechain and gate's key (sidechain) is the channel itself, but by pressing or clicking on the menu button in the dynamics detail area you are taken to the patching page where you can choose another source for these inputs. For side chain details, see "Side chain" on page 255.

Compressor

The input channel compressor has four styles — corrective, adaptive, creative and vintage — which are selectable via the **MODE** button. Each has a distinctive sound and a different appearance in the GUI channel strip. While the dynamic section is addressing the compressor, all of its controls are enabled except the **hold** control knob.

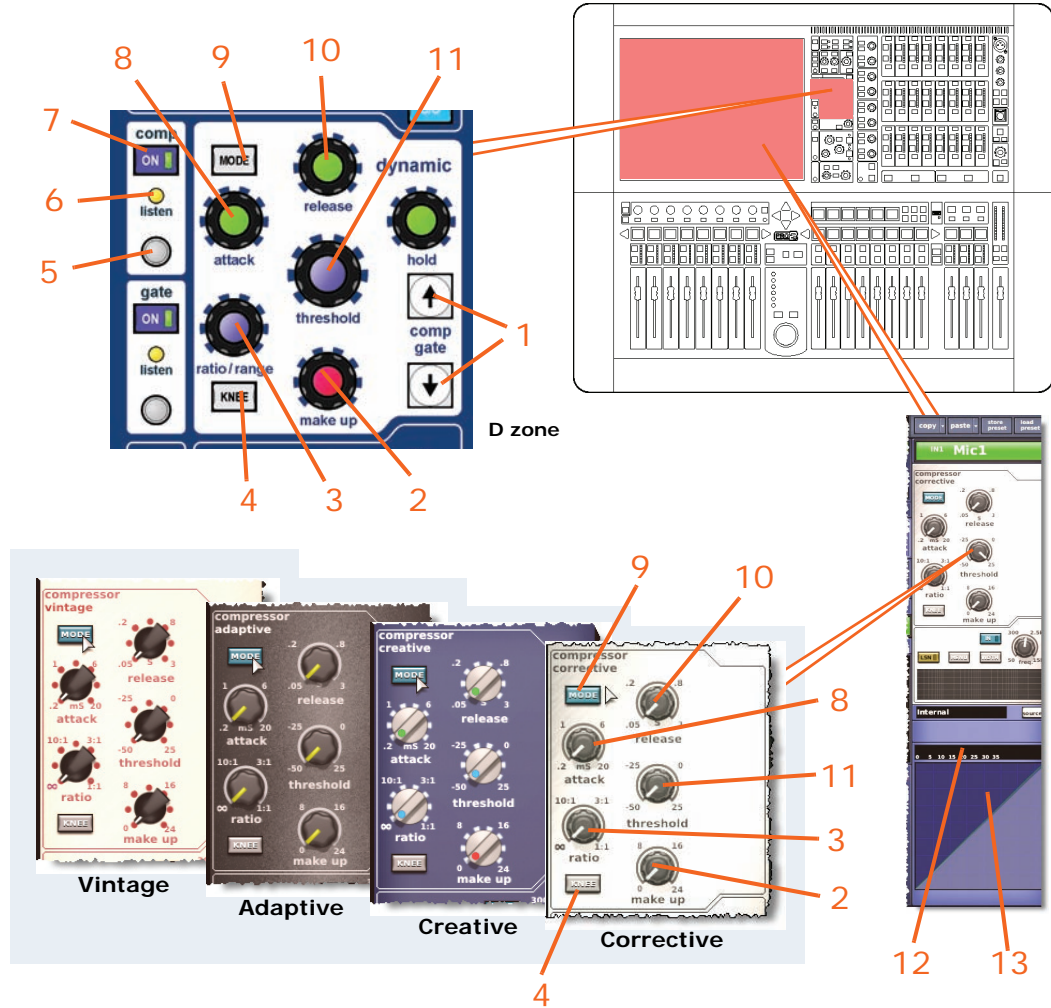

Item	Description
1	comp/gate up and down select buttons, for swapping <b>dynamic</b> section control from compressor to gate, and vice versa.
2	Compressor <b>make up</b> gain control knob, compensates for the reduced <i>loudness</i> of a compressed signal. Range is from 0dB to 24dB.
3	Compressor <b>ratio</b> control knob, adjusts amount of compression applied to signals above threshold. Range is from infinity ( $\infty$ ) to 1:1 (maximum), which sets the compressor to limiter mode.

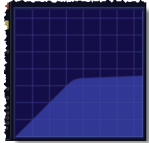
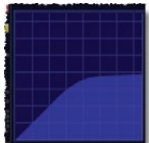
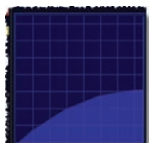
<i>Item</i>	<i>Description</i>
4	<p>Compressor <b>KNEE</b> switch, controls how compressor starts to apply gain as the signal goes through the threshold (see "About the compressor graph" on page 252). There are three knee types as follows, accompanied by their typical affects on the compressor graph:</p> <ul style="list-style-type: none"> <li>• <b>Hard knee</b> Compressor immediately applies gain reduction at selected ratio once attack time has elapsed. This knee has hardly any curve at all.</li> </ul>  <ul style="list-style-type: none"> <li>• <b>Medium knee</b> Intermediate knee type.</li> </ul>  <ul style="list-style-type: none"> <li>• <b>Soft knee</b> Compressor, starting from slightly before threshold, gradually makes the transition to applying gain reduction at selected ratio. This knee is noticeably more rounded.</li> </ul>  <p>For application notes, see "Knee" on page 290.</p>
5	Quick access button, which directly selects the compressor or gate detail areas on the input channel strip.
6	To aid set up, the compressor has a side chain listen that sends the side chain onto a solo bus. This side chain <b>listen</b> LED indicator illuminates to warn you that soloed material is from the side chain, and not the main channel. For information on the side chain, see "Side chain" on page 255.
7	<b>ON</b> switch, enables the compressor in the signal path. When switched off, compressor is bypassed. (Both the <b>comp</b> and <b>gate</b> switches can be on at the same time.)
8	Compressor <b>attack</b> control knob, adjusts time for compressor to respond after an over-threshold signal. Range is from 0.2ms to 20ms (milliseconds).
9	<b>MODE</b> switch, selects compressor mode. There are four compressor types available: <b>corrective</b> , <b>adaptive</b> , <b>creative</b> and <b>vintage</b> . See "PRO2 compressor modes (dynamic)" on page 289 for details.
10	Compressor <b>release</b> control knob, adjusts time for compressor to recover after programme material falls back below threshold. Range is from 0.05s to 3.00s (seconds).
11	<b>threshold</b> control knob, sets the signal level above which gain reduction starts to be applied. Range is from -50dB to +25dB.
12	Compressor 'gain reduction' meter.
13	Compressor graph (see "About the compressor graph" on page 252).

**About the compressor graph**

The GUI shows a graph of the compressor envelope (input level against the output level) to help you visualise the effect that the compressor is having on the signal (typically as shown right).

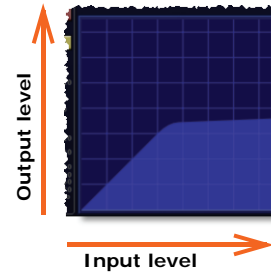

Figure 23 “Compressor graphs showing the effect of ratio” shows what happens to the compressor graph with and without ratio. Initially, both graphs have the same slope, which is pre-threshold and unaffected by compression; this has a gradient of 1:1 — ‘what you put into the compressor, you get out’. Without ratio the slope is constant and remains unaffected by compression. However, with ratio the gradient changes at threshold, which is the point where compression starts to be applied. After this the gradient of the post-threshold signal is at the selected ratio value.

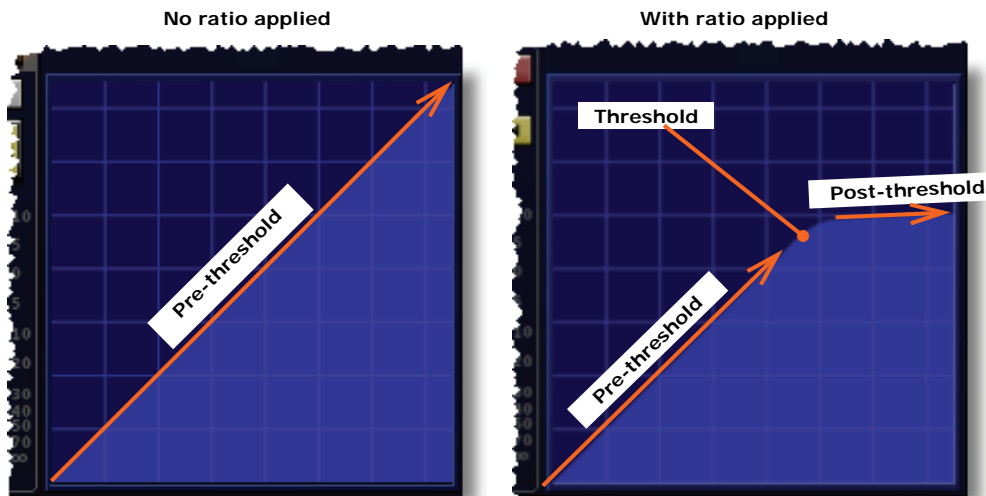
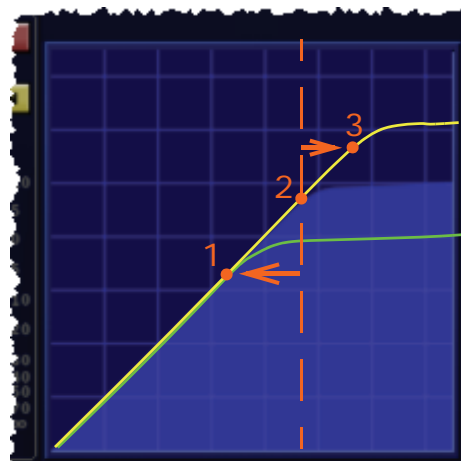

Figure 23: Compressor graphs showing the effect of ratio

The diagram right shows the effects of threshold adjustment. Position 2 is the threshold of the actual compressor graph shown on the GUI. If you reduce threshold (for example, to position 1), compression starts earlier and less signal is passed 1:1; the signal path would follow the green line. Conversely, increasing threshold (for example, to position 3) delays compression and more signal is passed 1:1; the signal path would follow the yellow line.



With a signal running through the compressor, a coloured line on the graph follows the contour of the shaded graph area. The line's colour changes according to signal level to show the level of compression, that is, uncompressed (green), within knee area (yellow) or at full compression (red). An example of each is shown in the following diagram.

Uncompressed

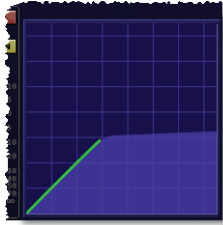

If signal doesn't reach threshold (point where gradient changes), the line is **green**. As the threshold is not exceeded, the signal is uncompressed.

Within knee area

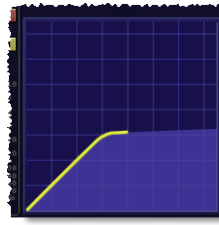

If signal goes into knee area to point where gradient changes (more obvious with medium and soft knees), compression starts to be applied and line colour changes to **yellow**.

Fully compressed

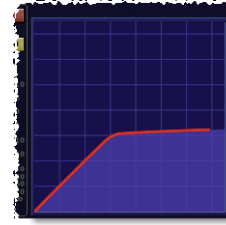

If signal reaches the point where gradient changes (over-threshold), full compression at selected ratio is applied and line colour changes to **red**.



## Gate

Unlike the compressor, gate mode has only one style. While the **dynamic** section is addressing the gate, all of its controls are enabled except the **make up** control knob and the **MODE** and **KNEE** buttons.

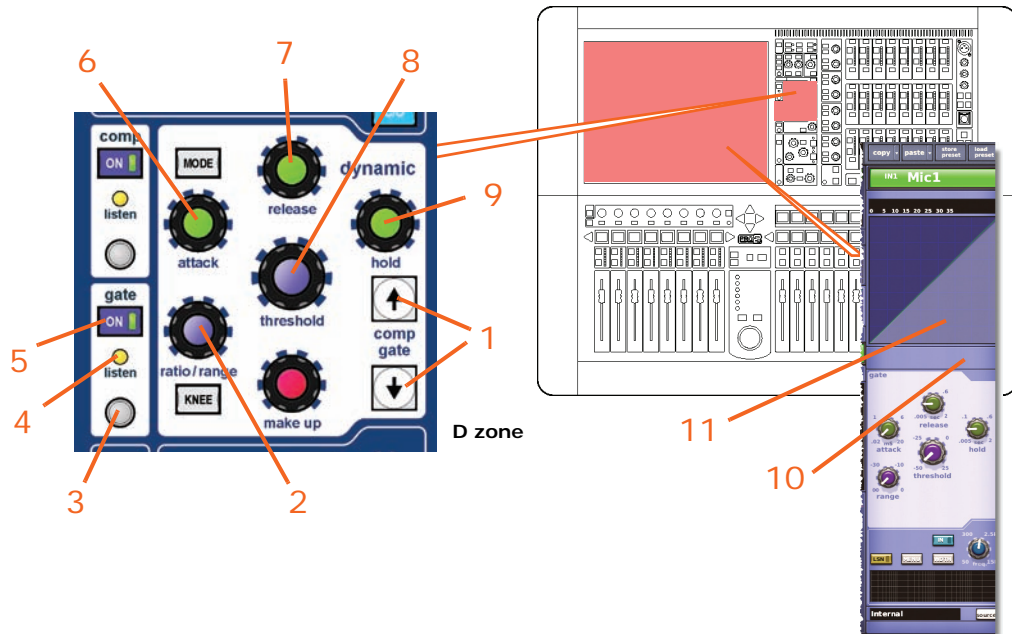

Item	Description
1	Up/down select buttons, for swapping <b>dynamic</b> section control from compressor to gate, and vice versa.
2	Gate <b>range</b> control knob, adjusts amount of gain reduction applied to the signal below threshold. Controls the maximum gain reduction that is possible. Range is from minus infinity ( $-\infty$ ) to zero.
3	Quick access button, which directly selects the compressor or gate detail areas on the input channel strip.
4	To aid set up, the gate has a side chain listen that sends the side chain onto a solo bus. This side chain <b>listen</b> LED indicator illuminates to warn you that soloed material is from the side chain, and not the main channel. For information on the side chain, see "Side chain" on page 255.
5	<b>ON</b> switch, enables gate in the signal path. When switched off, gate is bypassed. (Both the <b>comp</b> and <b>gate</b> switches can be on at the same time.)
6	<b>attack</b> control knob, adjusts time taken for gate to open after an over-threshold signal. Range is from 0.02ms to 20ms (milliseconds).
7	<b>release</b> control knob, adjusts time taken for gate to close after programme material falls back below threshold. Range is from -0.005s to 2.000s (seconds).
8	<b>threshold</b> control knob, sets signal level at which gate opens. Range is from -50dB to +25dB.
9	<b>hold</b> control knob, minimises chattering in conjunction with internal hysteresis. Once the signal is detected as below threshold, this defines a waiting period before the gate starts to close. Range is from -0.005s to 2.000s (seconds).



Item	Description
10	Gate meter.
11	Gate graph display. Similar to the compressor graph (see "About the compressor graph" on page 252), this shows the effects of adjusting the gate control knobs.

**Side chain**

You can manipulate the side chain filter from the **side chain** section (channel strip and GUI). The side chain filter is a swept band pass type, which acts on the dynamics side chains of the compressor and gate, and covers the full audio spectrum.

The image illustrates the side chain filter controls and their effects. It includes a 'Compressor' GUI, a 'Gate' GUI, and a 'side chain' control panel. The 'side chain' panel features an 'IN' switch (1), a 'freq' knob (2), and 'LISTEN' (5), 'MENU' (4), and 'WIDTH' (3) buttons. Below these are three graphs showing the frequency response of the side chain filter for different 'WIDTH' settings, with the 'freq' knob moving the envelope left or right.

Graphs showing the effects of the three filter Q options, selected via the **WIDTH** button

Item	Description
1	<b>IN</b> switch, switches the side chain filter into the sidechain signal path.
2	<b>freq</b> control knob, adjusts the side chain filter frequency in the range 50Hz to 15kHz. (Visually, this moves the envelope on the graph left or right.)
3	<b>WIDTH</b> button, changes the filter Q. There are three options, and the effects of each are shown in the side chain graph (see above). This is only enabled when the side chain filter is switched on.

<i>Item</i>	<i>Description</i>
4	<b>MENU</b> button, opens the <b>Select Side-Chain Source</b> window from which you can select the side chain source for the selected input channel (see "Side chain" on page 255). Pressing this button with the <b>Select Side-Chain Source</b> window open, closes the window.
5	<b>LISTEN/[LSTN]</b> switch, places the side chain pushbutton onto the channel filter bus, allowing the audio signal to be monitored via headphones. This effectively replaces the channel solo audio path with a post-filter (pre-dynamic) signal.
6	Graph, shows the effects of the side chain filter on the signal.
7	Side chain source field, shows you where the side chain of the compressor/gate is sourced from. If you see the text "internal" here, it means that the source is from the channel itself.

For details of how to select a side chain pick-off point, see "Side chain" on page 255.

## Insert

Input channel insert section provides a send and return out of the signal path, primarily so that an effects device can be added to the signal's processing. The send destination and return source may only be set from the GUI screen, although the **INS** switch can be found on both the GUI and also in each input fast strip. This section is optional and assigned on a channel-by-channel basis.

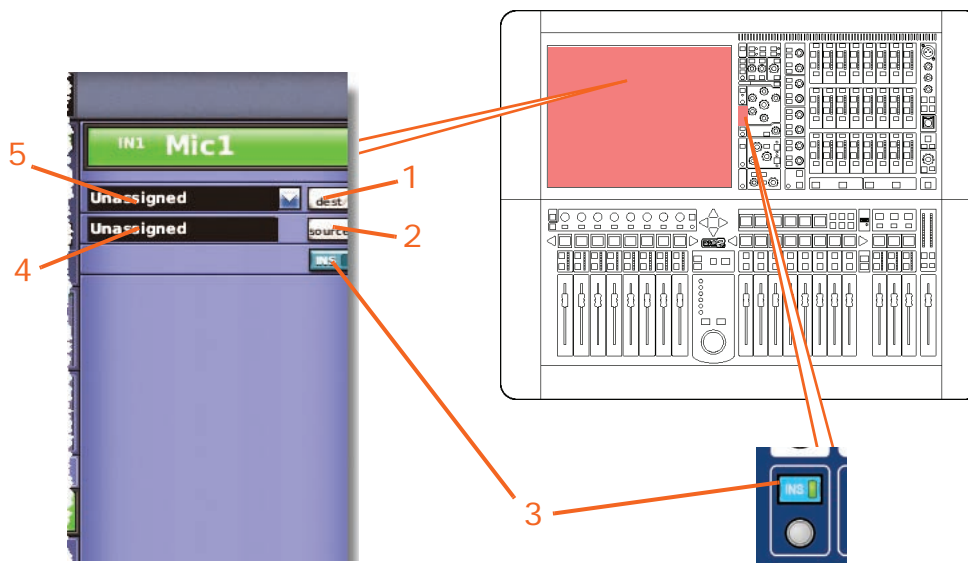

<i>Item</i>	<i>Description</i>
1	<b>dest</b> button opens the <b>Patching</b> screen from where you can select the destination of the insert send.
2	<b>source</b> button opens the <b>Patching</b> screen from where you can select the source of the insert return.
3	<b>INS</b> switch, connects (inserts) returned programme material to the channel signal path, provided both the insert send and insert return points have been assigned.

Item	Description
4	Insert return field shows you the source of the insert return.
5	Insert send field has a drop-down list, which shows the destination(s) of the insert return.

## EQ (E zone)

The input channel equaliser (EQ) is a four-band swept parametric EQ (PEQ) that allows tonal control of the input signal via the parametric EQ section, or E zone, in the input channel strip. The four bands are treble, hi-mid, lo-mid and bass, with an additional three shelving modes available for treble and bass. Any combination of the four bands can be used to control the signal, although only one band can be adjusted in the E zone at any time.

The E zone contains all of the PEQ controls, along with a shelving mode selection button and a set of band selection buttons.

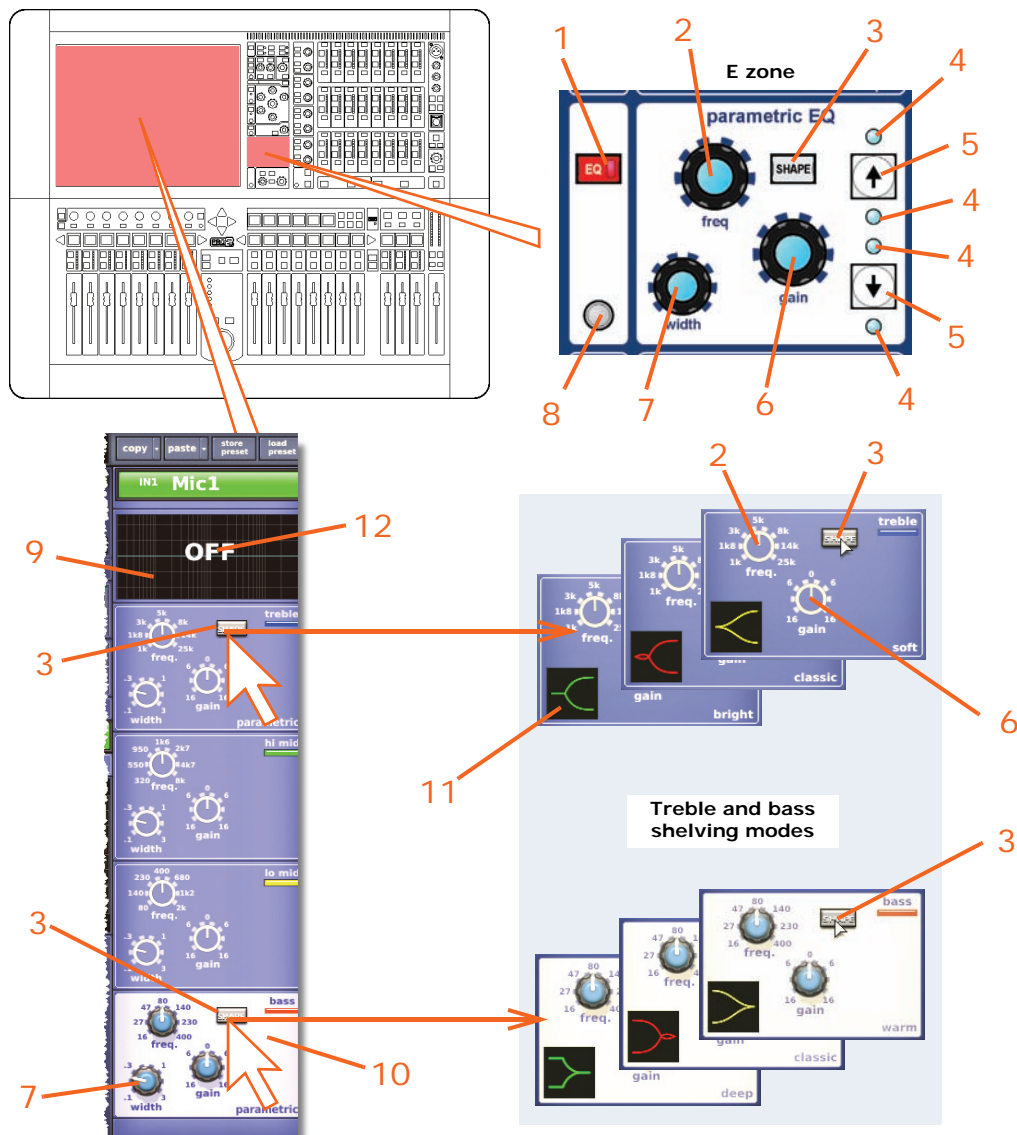

<i>Item</i>	<i>Description</i>
1	<b>EQ</b> on/off switch.
2	<b>freq</b> control knob adjusts the band's centre frequency. The frequencies that each band covers increases as you move from the bass band to the treble band. The graph in the EQ detail area on the GUI channel strip gives you a visual indication, once some gain has been applied, of where the band is located.
3	<b>SHAPE</b> button, changes shelving mode on treble and bass bands. For recommended usage, see Table 12 "Recommended band mode usage" on page 258. For a description of each mode, see "PRO2 input channel EQ modes" on page 292.
4	Four blue LED indicators, illuminate to show the band the E zone controls are controlling.
5	Up/down band selection buttons, cycle through the bands, changing what the E zone controls are controlling.
6	<b>gain</b> control knob, adjusts the gain of each band in the range -16dB to +16dB. And on the graph in the EQ detail area of the GUI channel strip, this causes the envelope to move up/down.
7	<b>width</b> control knob, adjusts the signal bandwidth in the range 0.1 Oct to 3.0 Oct. On the graph in the EQ detail area (GUI channel strip), causes the base of the envelope to widen. (Not available for treble and bass shelving modes.)
8	Quick access button, selects the EQ detail area (E zone) of the input channel strip.
9	Graph of EQ envelope.
10	Highlighted section indicates the band the E zone controls are currently controlling.
11	Icon representing the shape of the signal's envelope; note how the treble modes point to the left and the bass ones to the right.
12	"OFF" is displayed when the EQ is switched off.

In the GUI channel strip, the EQ detail area displays all four bands simultaneously and has a graph that shows a colour-coded EQ envelope for each selected band. Here, you can view the settings of the four bands simultaneously. The GUI also shows the ranges available for each control knob and indicates the active band, which is distinguished by its cream-coloured background.

The following table illustrates the recommended uses of the treble and bass shelving modes.

**Table 12: Recommended band mode usage**

<i>Band</i>	<i>Mode</i>	<i>Best</i>
Treble	Bright	On single source material
Treble	Classic	Good for single source and pre-mixed material
Treble	Soft	For gentle shaping of pre-mixed material
Bass	Deep	On single source material
Bass	Classic	All round EQ
Bass	Warm	For gentle shaping of pre-mixed material

## Mixes

Each input channel can send an individually controllable contribution to each of the 16 aux buses (**aux sends**) and eight matrix buses (**mtx sends**). The contributions to the buses are controlled by mix controls that give continuous adjustment (in the range +6dB to off). The controls in the mix fader bay include **level/pan** and **level** control knobs, with the pan control coming into operation when the corresponding bus is stereo linked to its neighbour.

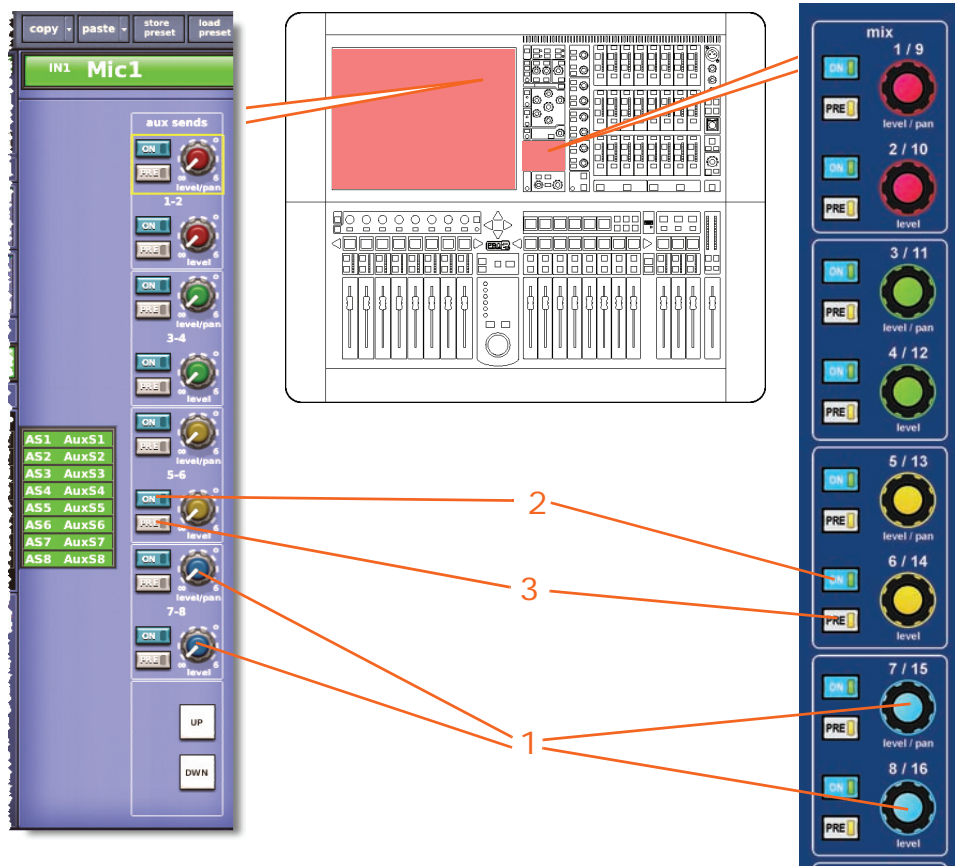

Item	Description
1	After an input channel has been selected to the channel strip, <b>level/pan</b> and <b>level</b> control knobs offer control of relative contribution levels onto the active buses. <b>level/pan</b> operates odd numbered controls, while <b>level</b> operates the even ones.
2	<b>ON</b> switches, switch bus assignment on/off.
3	<b>PRE</b> buttons; when on, signal is pre-fader.

The **mix** section in the channel detail area controls a bank of eight buses per selected input channel and this layout is replicated in the GUI channel strip.

However, the GUI's **input channel overview** gives a simultaneous display of the status of all 24 buses. It displays the levels sent to the buses and shows which are on/off and whether they are pre- or post-fader.

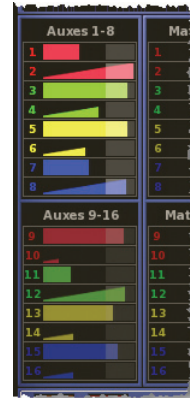

*Don't forget, you can edit the levels on the GUI using drag.*

Mix busses can operate in one of three modes and each mix bus can optionally be stereo linked to the bus next to it. So, depending on the set up, some of the mix bus controls change their function and some might not be available. In each of the modes the following controls are available:

<b>Bus type</b>	<b>Control</b>
Mono mix	<b>level</b> control knob and <b>ON</b> and <b>PRE</b> buttons. Also, if <b>PRE</b> is not enabled, the level sent to the mix bus is affected by the main fader control.
Stereo mix	<b>level</b> control knob, <b>level/pan</b> control knob (level control knob for the odd numbered bus) and <b>ON</b> and <b>PRE</b> buttons. Also, if <b>PRE</b> is not enabled, the level sent to each side of the stereo bus is affected by the main fader and pan controls.
Mono group	<b>ON</b> button only. The level sent to the group bus is controlled by the main fader control.
Stereo group	<b>ON</b> button only. The level sent to each side of the stereo bus is controlled by the main fader and pan controls.
Mono mix minus	<b>ON</b> button only, which is labelled <b>minus</b> on the GUI fast inputs and channel strip overview. The level sent to the bus is controlled by the main fader control. This switch works the opposite way round to normal, and when it is on the audio is not sent to the bus.
Stereo mix minus	<b>ON</b> button only, which is labelled <b>minus</b> on the GUI fast inputs and channel strip overview. The level sent to the side of the stereo bus is controlled by the main fader and pan controls. This switch works the opposite way round to normal, and when it is on the audio is not sent to the bus.



## Master controls

In general, there are three routing switches to the master buses and also pan control. Pan provides master panning as three-way or two-way (depending on SIS™ setting) and also provides two-way panning for any stereo mix groups stereo and subgroups etc. (When used in fader flip mode, sends to mix buses are controlled from the channel master pan and fader.

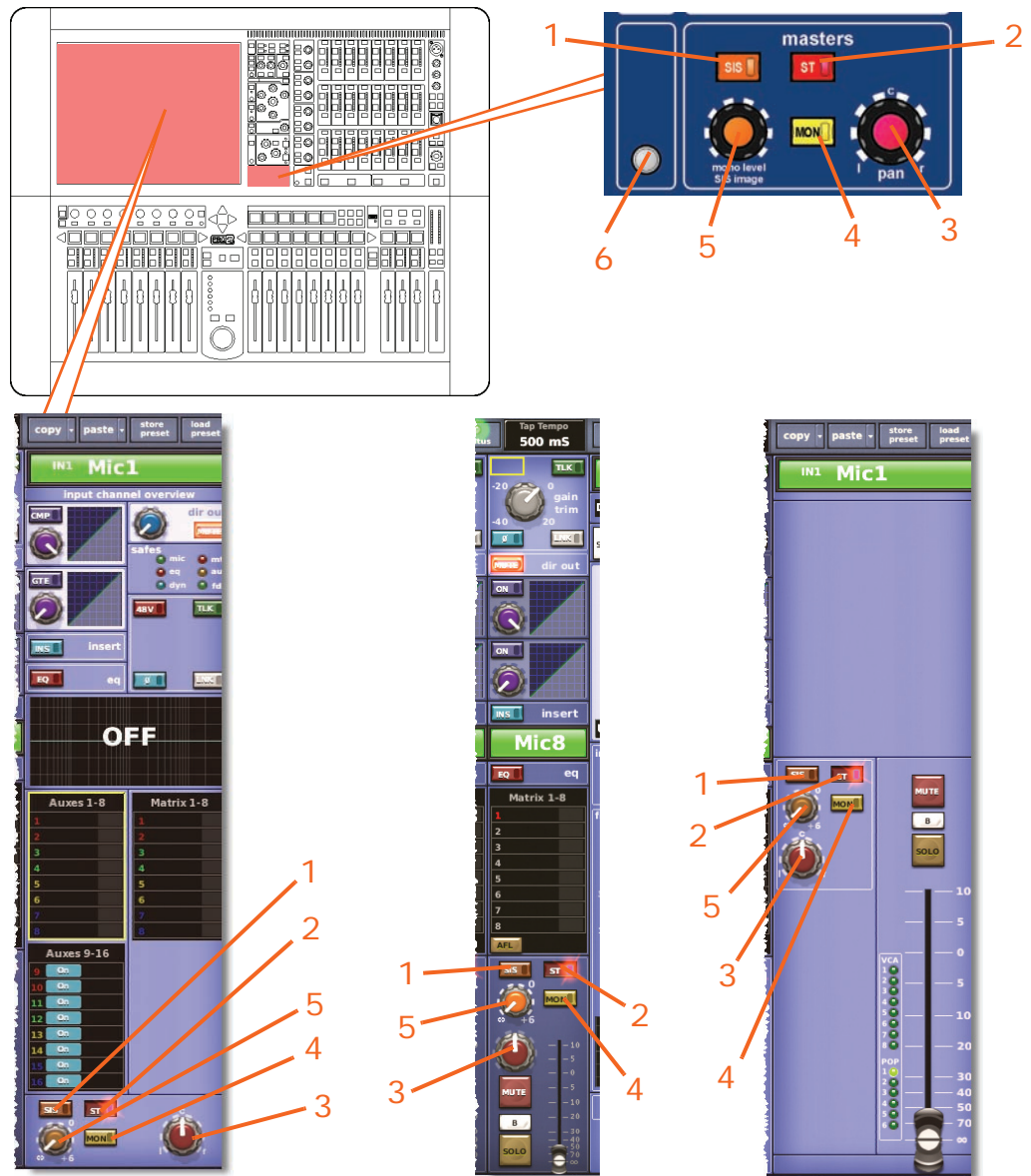

Item	Description
------	-------------

- |   |   |
|---|---|
| 1 | <b>SIS</b> (spatial imaging system) switch, enables SIS™ mode. This mode operates with the <b>pan</b> and <b>mono level SIS image</b> control knobs, and acts as an LCR master bus enable, overriding stereo and mono master bus assignments. However, their status remains in memory so that when <b>SIS</b> is disengaged, the mono and stereo settings can return. Pressing <b>SIS</b> alters the gradations of the <b>mono level SIS image</b> control knob on the GUI. |
| 2 | <b>ST</b> (stereo) switch, connects post-fader channel signal to master stereo bus via pan control.   |

---

<i>Item</i>	<i>Description</i>
<b>3</b>	<b>pan</b> control knob, adjusts the relative levels sent to a left-right bus pair or the master left-centre-right (LCR) buses. In SIS™ mode, it can also control the 'image' to give a constant power crossfade from LCR to stereo.
<b>4</b>	<b>MON</b> (mono) switch, connects post-fader channel signal to mono master bus.
<b>5</b>	<b>mono level/SIS image</b> dual-function control knob. In mono mode, it acts as a mono level control knob to adjust the mono signal level. In SIS™ mode, it becomes a SIS image control knob that modifies <b>pan</b> control knob operation to place the channel within a three-speaker system (see "Stereo panning" on page 97).
<b>6</b>	Quick access button, selects the master detail area on the GUI channels strip.

---

For more details, refer to "Stereo panning" on page 86 and "Spatial imaging system (SIS™)" on page 313.



## Solo, mute and fader

Each input fast strip contains the **MUTE** and **SOLO** buttons motorised fader. The fader is replicated in each input fast strip on the GUI and also in the masters detail area (GUI channel strip). The fader controls the channel signal level and provides instant feedback of level settings.

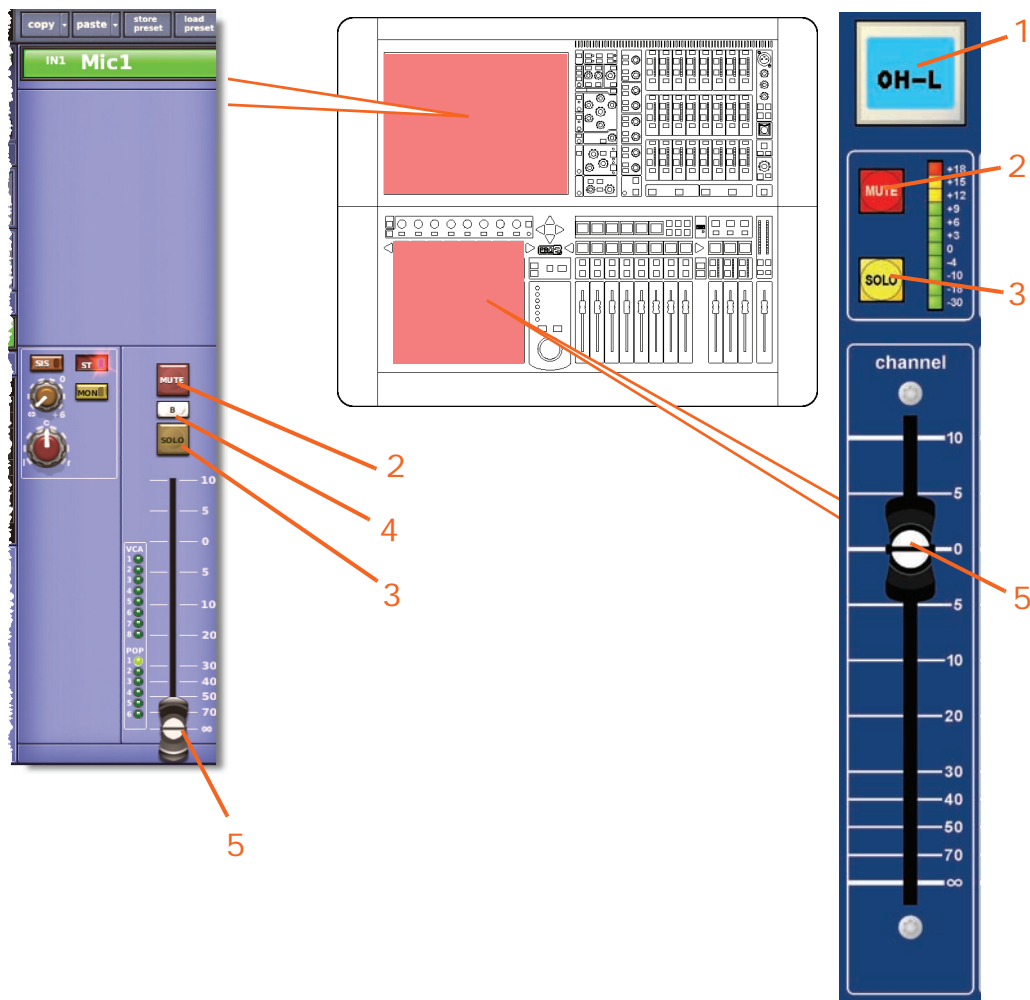

Item	Description
1	LCD select button.
2	<b>MUTE</b> button, mutes all post-processing signals exiting the channel. In addition to scene recall, it can also be remotely muted from the auto-mute masters.
3	<b>SOLO</b> button, activates signal routing to the monitor A or B section of the control centre (depending on the status of the solo B button) by sending the input channel signal to PFL mono and AFL stereo buses. The solo system is auto-cancelling, so that each new solo cancels the last one. Input solos override any active VCA and bus solos.
4	Solo <b>B</b> button (GUI only), changes the operation of the <b>SOLO</b> switch so that it routes signals to the monitor B section of the control centre.
5	Motorised fader.

This button is a latching type. Give a short press to latch it and a long press to self-cancel when it is released.

The LCD select buttons in the input fast strips are used for input channel navigation and group selection. They also provide useful feedback for the user.

For more information on navigation, see "About the PRO2 controls" on page 37.

### Aux returns

The aux returns are input channels and their functionality is as broadly described for the mic inputs in the earlier sections of this chapter.

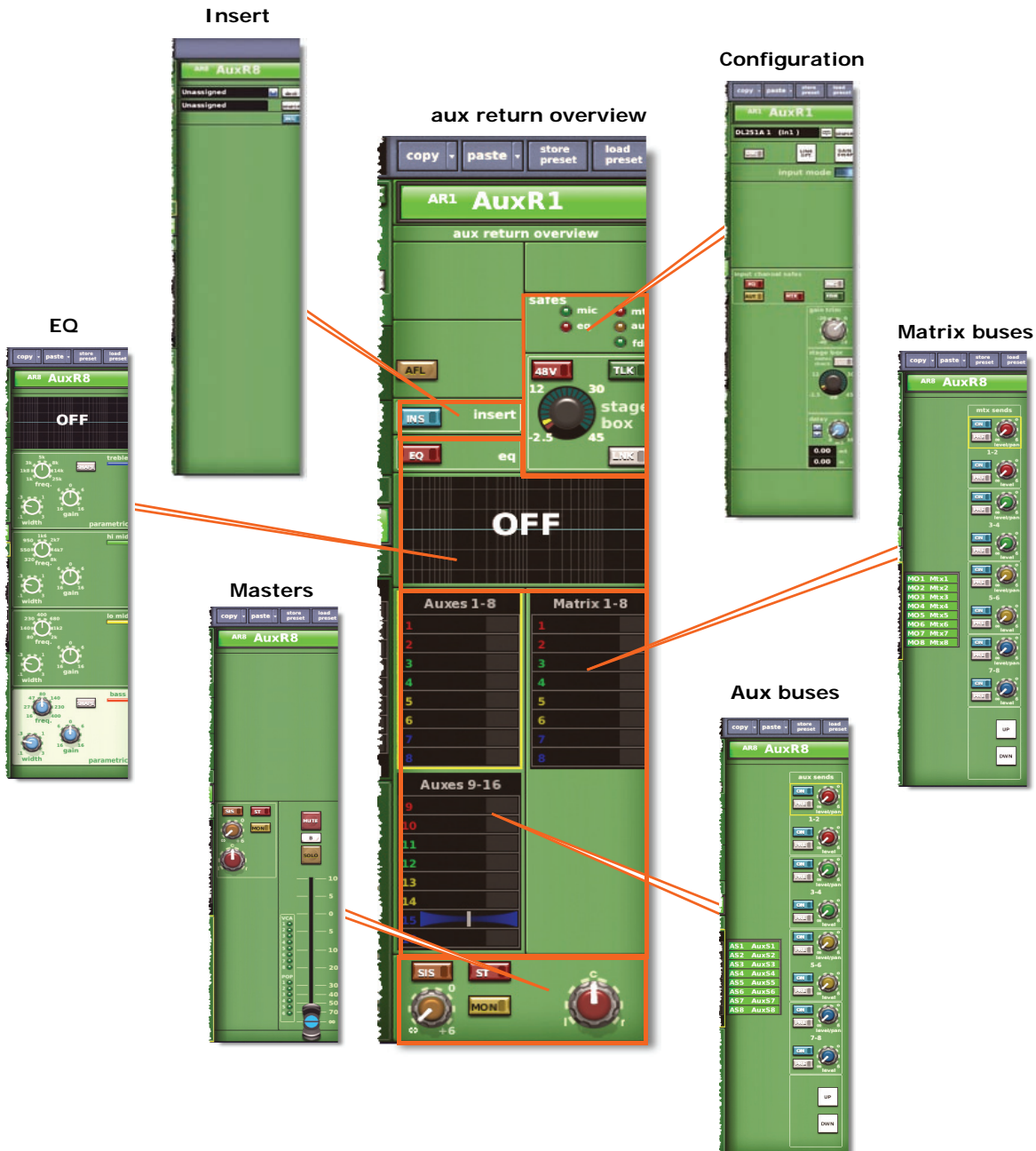

Figure 24: Processing areas available from the *aux return overview* display

## Chapter 31: Output Channels

This chapter shows you the areas on the control surface that are used to manage the outputs and also describes their function. There are three type of output: auxes, matrices and masters.

The structure of this chapter is loosely based on the signal path of the output channels and also the processing areas, which are opened via the output channel overview displays in the GUI channel strip.

### Output channel routing

The following table shows the approximate signal path of each output type.

<i>Channel controls</i>	<i>Aux</i>	<i>Matrix</i>	<i>Master</i>
<b>Configuration</b>	See page 279	See page 279	See page 279
<b>Direct input</b>	See page 281	See page 281	See page 281
<b>*#Dynamics (dual compressor)</b>	See page 273	See page 273	See page 273
<b>Insert</b>	See page 281	See page 281	See page 281
<b>*EQ</b>	See page 274	See page 274	See page 274
<b>Mixes</b>	Matrix sends only (see page 282)	N/A	N/A
<b>Master controls, solo select and fader</b>	See page 282	See page 282	See page 282

\* Order can be swapped (see "Processing order" on page 281).

# Includes side chain section.

### Output channel areas on the control surface

In the default mode of operation the output channels are assigned to the mix faders. However, by using the **OUTPUT** and **EXTEND** buttons (see the PRO2 Live Audio System Quick Start Guide) they can also be extended to the channel faders as well. Detail adjustment is augmented by the channel detail areas. The hardware controls are replicated on GUI, which also provides extensive support and additional functionality.

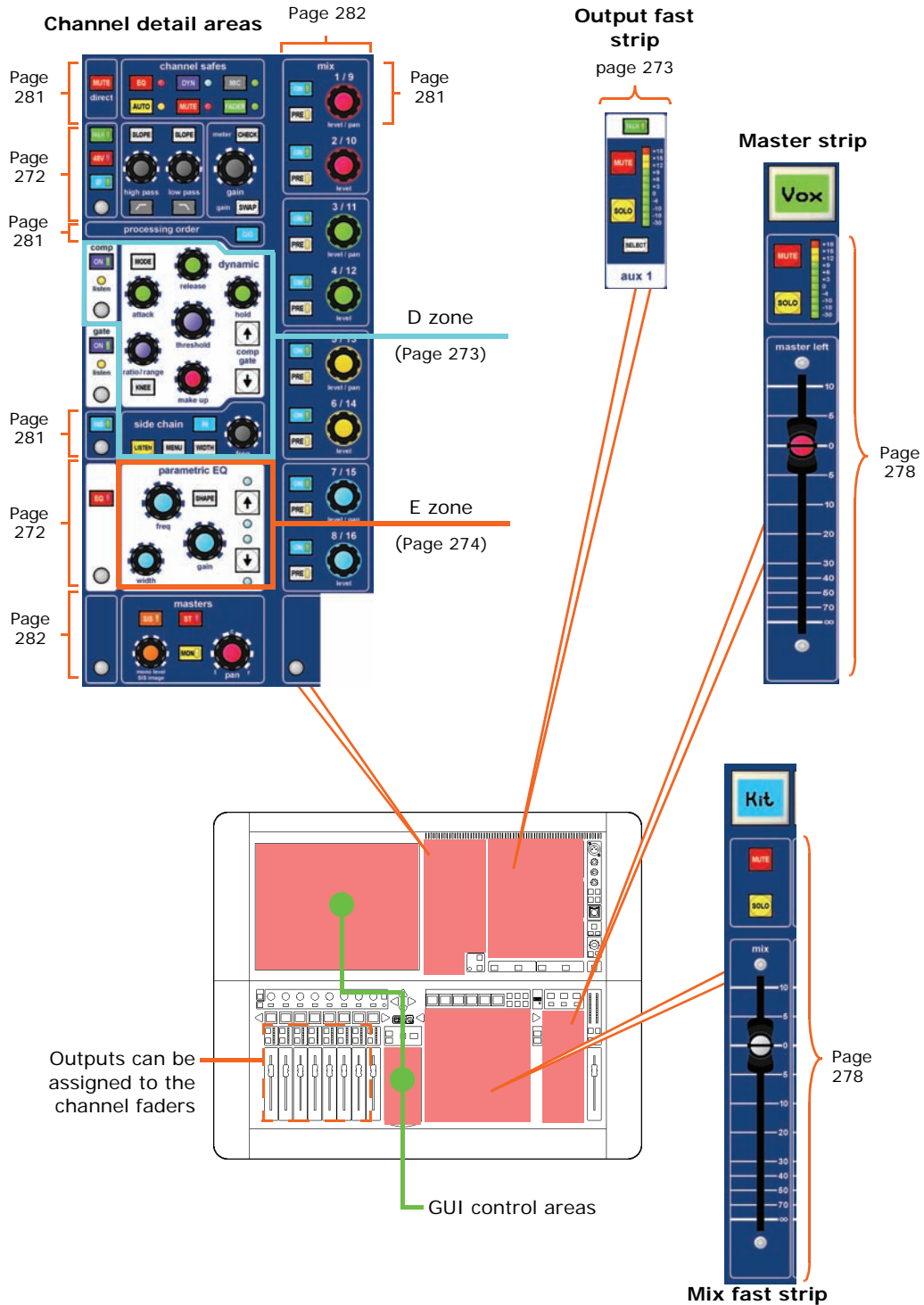

## Outputs on the GUI

The outputs are represented on the GUI in a similar way to the inputs, although each has a different coloured background. Each output channel has a GUI fast strip and these are displayed in banks of eight (except for the three masters). When a channel is selected, its overview is displayed in the GUI channel strip; selecting a non-control area in an overview section will open its associated detail area. This will be detailed more fully later on in this chapter.

All of the outputs are shown in on the **Console Overview** screen of the GUI and each has its own meter. For more information, see “Input metering” on page 241.

### GUI output fast strips

The output fast strips on the GUI (a typical example is shown right) give an overview of their equivalent versions on the control surface. These show the gain, bus controls, pan control knob and fader.

Some detail areas are configuration dependent, such as the bus sends (depends on surround configuration) and console gain/digital trim.

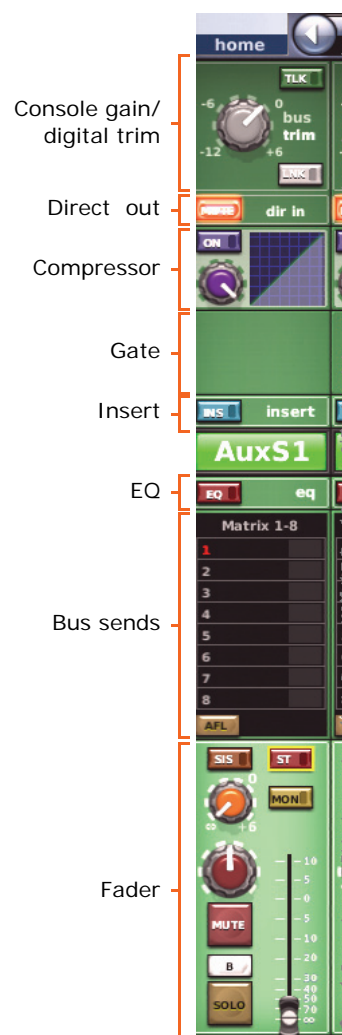

### GUI channel strips

When a channel is selected, its ‘overview’ appears in the channel strip. For diagrams showing the ‘overview’ of each output and all their processing areas, see Figure 25, Figure 26 and Figure 27.

As with the input channels, the output overview provides a limited set of controls and status information (see “Inputs on the GUI” on page 239).

## Processing areas

The following processing areas are available from 'overview' displays in the GUI channel strip. To see the available processing areas for each output, see Figure 25, Figure 26 and Figure 27.

<i>Channel controls</i>	<i>Aux</i>	<i>Matrix</i>	<i>Master</i>
<b>Insert only</b>	N/A	N/A	N/A
<b>Configuration only</b>	N/A	N/A	N/A
<b>Insert and configuration</b>	Yes	Yes	Yes
<b>Compressor</b>	Yes	Yes	Yes
<b>EQ</b>	Yes	Yes	Yes
<b>Buses</b>	Yes (matrix only)	N/A	Yes (matrix only)
<b>Solo, mute, safes and fader only</b>	N/A	Yes	N/A
<b>Masters and solo, mute, safes and fader</b>	Yes	N/A	Yes

For details of how to navigate the GUI channel strip, see "About GUI navigation" on page 46.

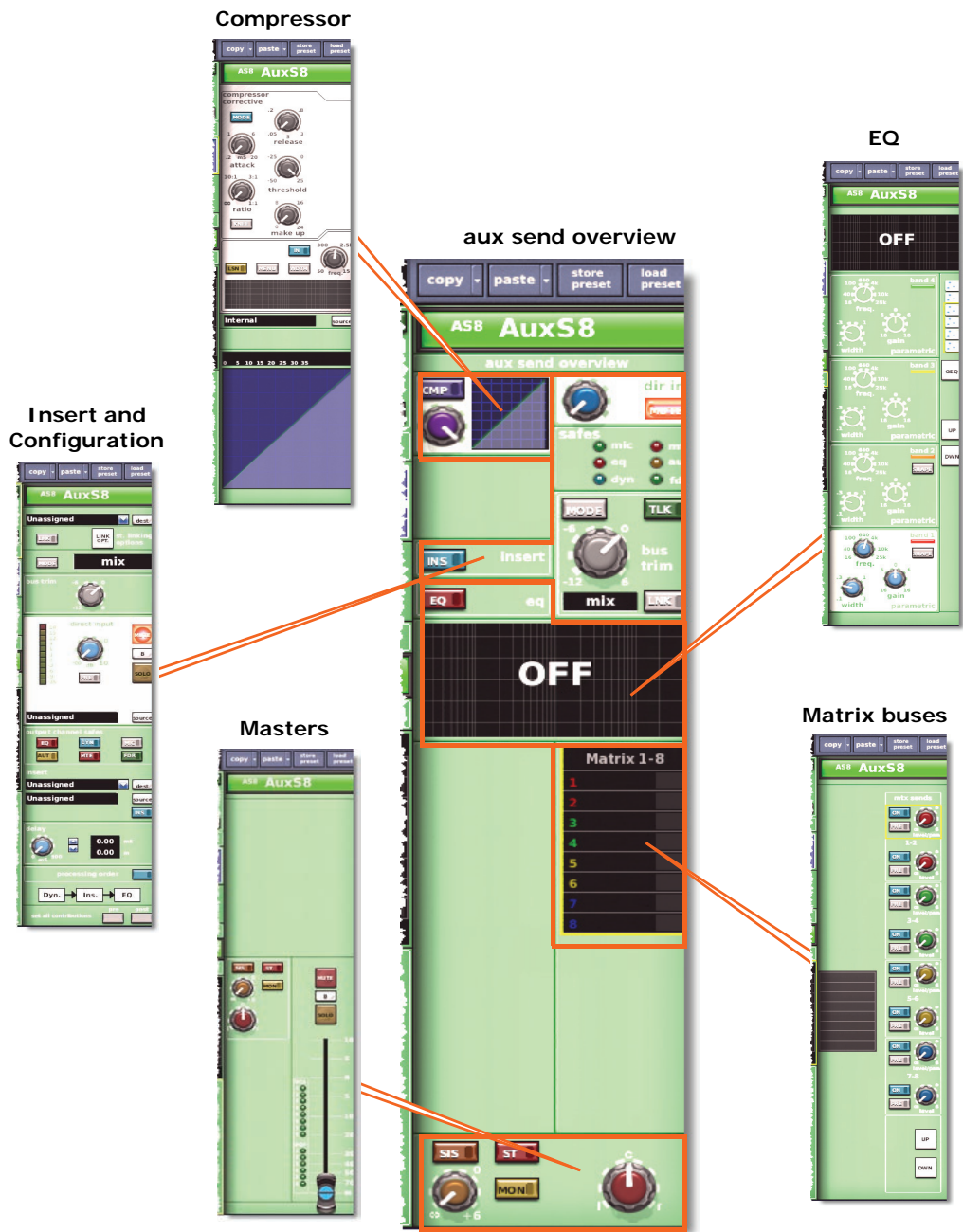

Figure 25: Processing areas available from the *aux send overview* display



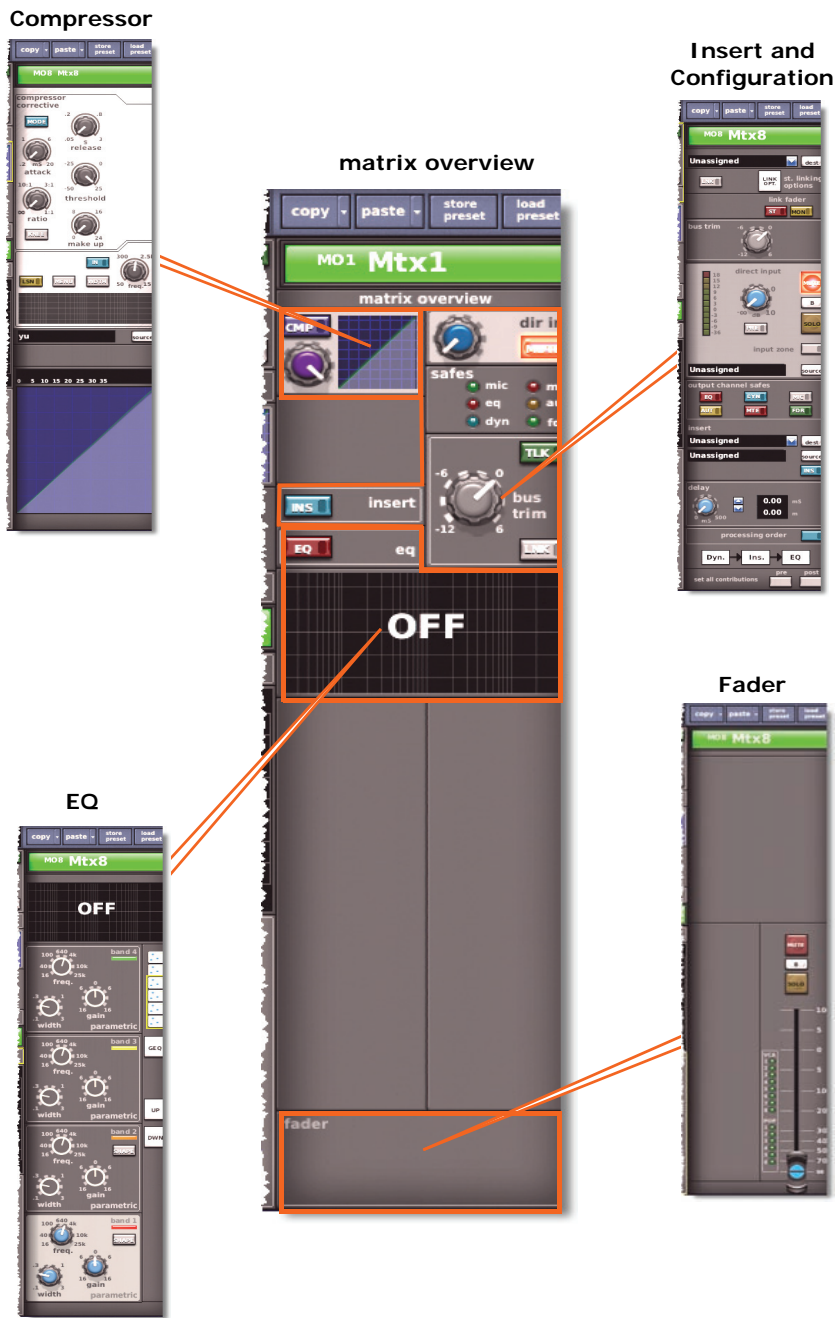

Figure 26: Processing areas available from the **matrix overview** display



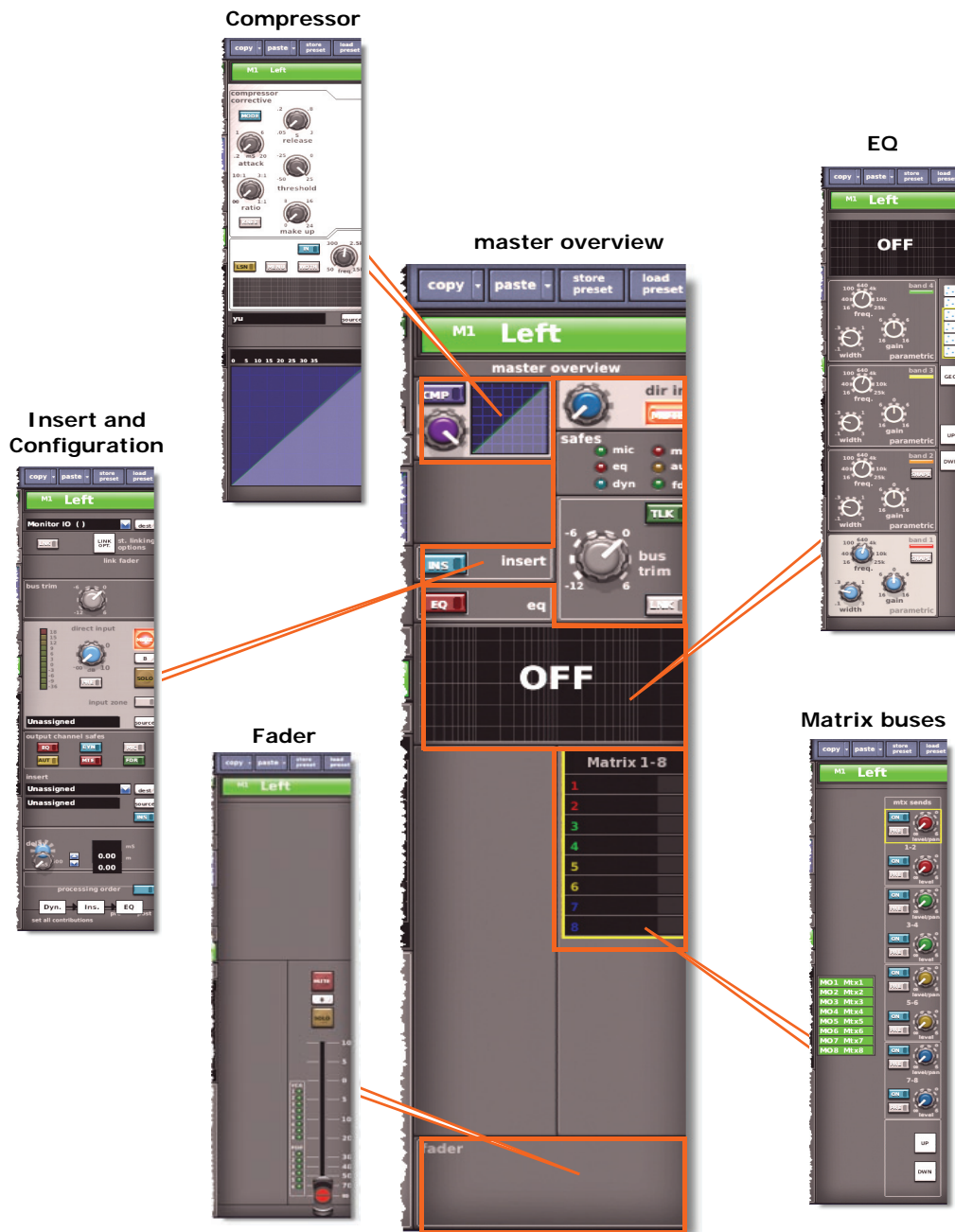

Figure 27: Processing areas available from the **master overview** display

## Output metering

Each output fast strip on the control surface has an 11-segment LED meter and all of the outputs are shown in on the **Console Overview** screen of the GUI, each with its own meter. For more information, see "Input metering" on page 241.

### Talk

There is a talk switch in each output fast strip and also on the output 'overview' displays of the GUI channel strip, which are labelled "TALK" and "TLK", respectively.

If the **TALK/[TLK]** (internal) switch in the **talk mic** section is active, the talk buttons will illuminate to prompt the operator to select a bus that the talk signals should be routed to. These are also used to set up a talk group after pressing one of the **talk/osc routing** panel buttons.

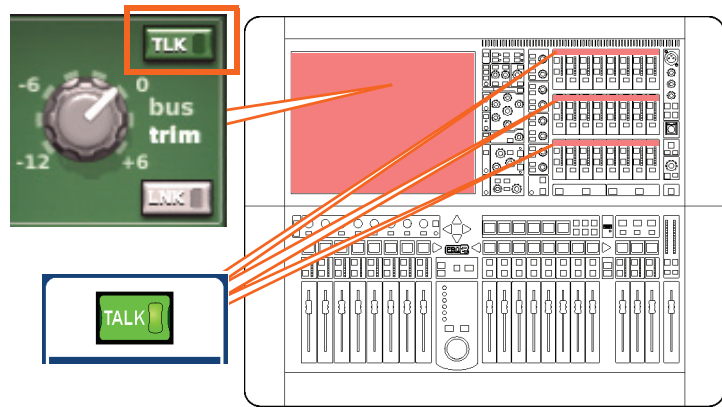

### Dynamics and EQ

The control surface has a combined dynamics and EQ section that contains **DYN** and **EQ** on/off buttons, and a **listen** LED (yellow) that illuminates when listen is active in the output processing area to show when a channel has its dynamic side chain soloed.

In the GUI channel strip overview display the aux, matrix and master outputs each have a compressor section and an EQ section (both are highlighted in the diagram below). Clicking within either of these sections will open their respective processing areas, which are described in the following subsections.

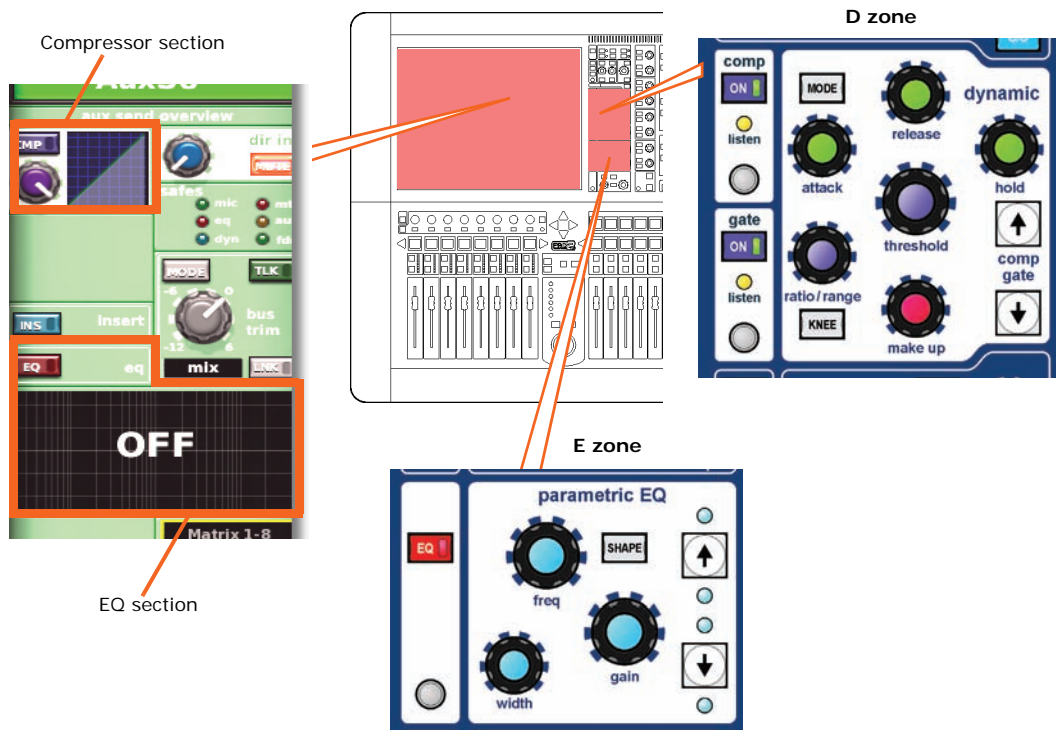

**Compressor (D zone)**

For the outputs, the **dynamic** section (D zone) only has a compressor in the output channel signal path. As the D zone is also used for the gate on the input channels, some controls may be redundant.

The output channel compressor has five styles — corrective, adaptive, creative, vintage and shimmer — which are selectable via the **MODE** button. Each has a distinctive appearance in the GUI channel strip. While the dynamic section is addressing the compressor, all of its controls are enabled except the **hold** control knob.

For details of the compressor graph, see “About the compressor graph” on page 252.

The side chain is similar to the one used for the input channels, see “Side chain” on page 255.

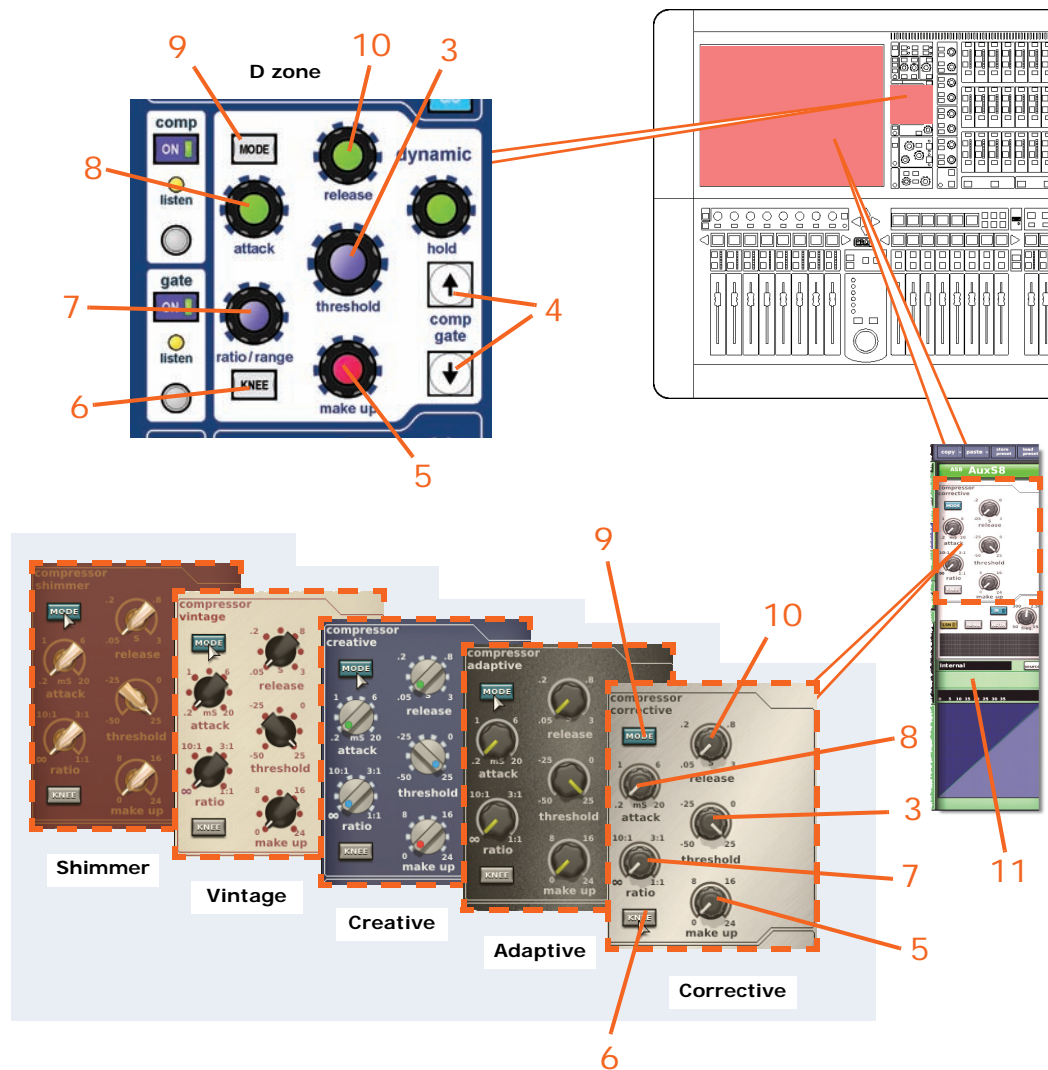

Item	Description
1	<b>ON</b> switch, enables the compressor in the signal path. When switched off, compressor is bypassed.
2	To aid set up, the compressor has a side chain listen that sends the side chain onto a solo bus. This side chain <b>listen</b> LED indicator illuminates to warn you that soloed material is from the side chain, and not the main channel.

<i>Item</i>	<i>Description</i>
3	<b>threshold</b> control knob, sets the signal level above which gain reduction starts to be applied. Range is from -50dBu to +25dBu.
4	<b>comp/gate</b> up and down select buttons, for swapping <b>dynamic</b> section control from compressor to gate, and vice versa.
5	Compressor <b>make up</b> gain control knob, compensates for the reduced <i>loudness</i> of a compressed signal. Range is from 0dB to 24dB.
6	Compressor <b>KNEE</b> switch, controls how compressor starts to apply attenuation as the signal goes through the threshold (see "About the compressor graph" on page 252). For more information, see "Knee" on page 290.
7	Compressor <b>ratio/range/[ratio]</b> control knob, adjusts amount of compression applied to signals above threshold. Range is from infinity ( $\infty$ ) to 1:1. When set to infinity it sets the compressor to limiter mode.
8	Compressor <b>attack</b> control knob, adjusts time for compressor to respond after an over-threshold signal. Range is from 0.2ms to 20ms (milliseconds).
9	<b>MODE</b> switch, selects compressor mode from the five compressor types available (see "PRO2 compressor modes (dynamic)" on page 289).
10	Compressor <b>release</b> control knob, adjusts time for compressor to recover after programme material falls back below threshold. Range is from 0.05s to 3.00s (seconds).
11	Compressor 'gain reduction' meter (not displayed).

## EQ (E zone)

For tonal control of the aux, matrix and master output signals, the output channel EQ has the option of a six-band sweep parametric EQ (PEQ) or an assignable graphic EQ (GEO).

### PEQ

The parametric EQ section (E zone) of the channel strip (mix and master bays) allows tonal control of the input signal. The E zone contains all of the PEQ controls, along with a shelving mode selection button and another set of band selection buttons.

All of the outputs have six-band PEQs. Two of the six bands have three shelving modes each, while another has just one. Any combination of the six bands can be used to control the signal, although only one band can be adjusted in the E zone at any time. However, the EQ processing area (GUI channel strip) displays four bands at any time, and also has navigational controls.

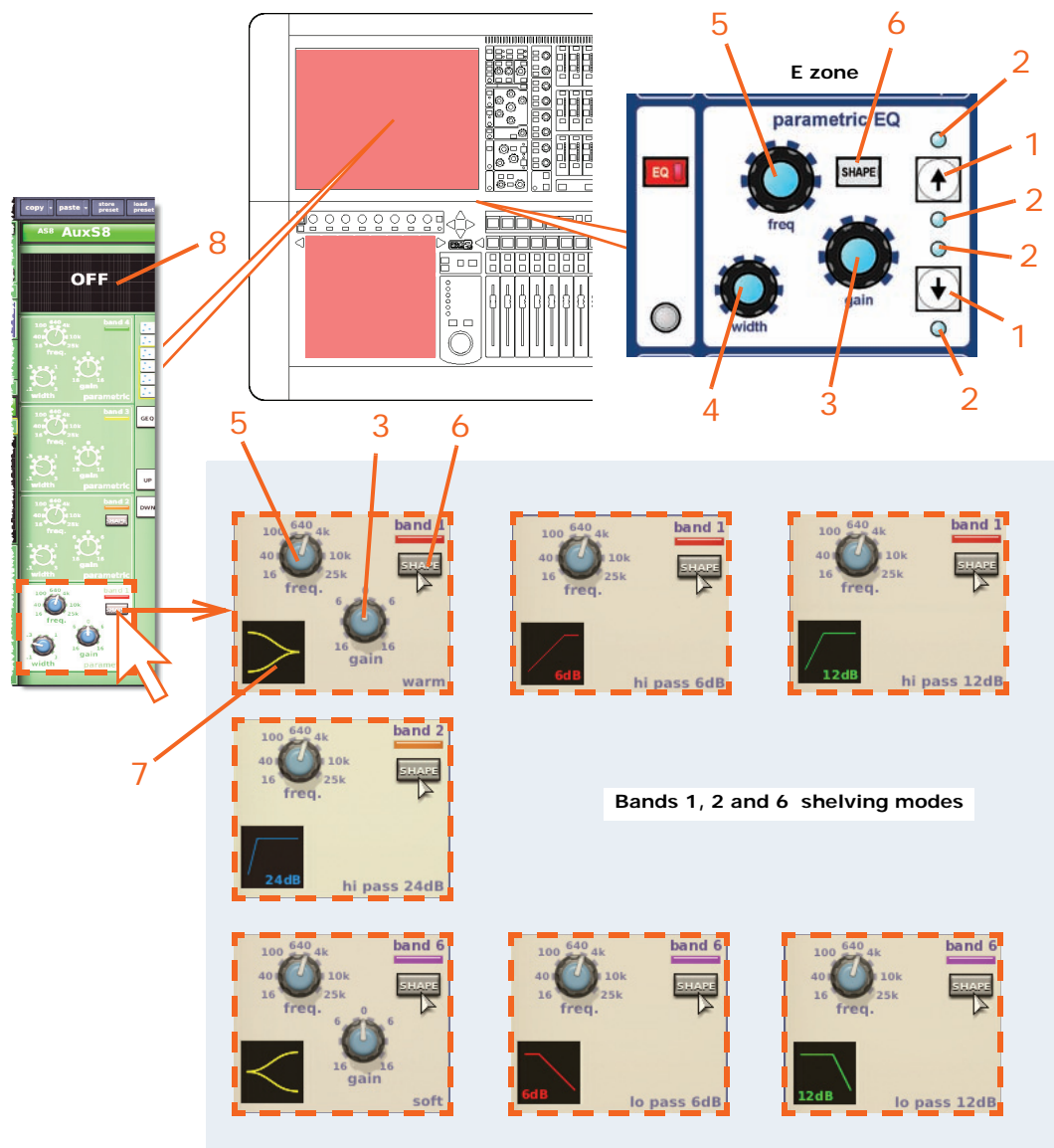

**Item Description**

- 1 Up/down band navigation buttons (see “Navigating the PEQ output bands” on page 277). Also used in conjunction with the blue adjacent LEDs to show which band is currently selected. Illuminated up arrow means that band 5 is selected, and illuminated down arrow means that band 2 is selected.
- 2 Four blue LEDs, illuminate to show the current band selection. Used in conjunction with the up and down buttons, they show — from the bottom LED upwards — when band 1, 3, 4 or 6 is selected.
- 3 **gain** control knob, adjusts signal gain in the range -16dB to +16dB. On the graph in the EQ processing area (GUI channel strip), causes the envelope to move up/down, inverting as it passes the origin.
- 4 **width** control knob, adjusts the signal bandwidth in the range 0.1 Oct to 3.0 Oct. On the graph in the EQ processing area (GUI channel strip), causes the base of the envelope to widen. (Not available for shelling modes.)



<i>Item</i>	<i>Description</i>
5	<b>freq</b> control knob, adjusts signal frequency. The range is band-dependent. On the graph in the EQ processing area (GUI channel strip), causes the envelope to move left/right.
6	<b>SHAPE</b> button, changes the shelving mode on treble and bass bands. For a description of each mode, see "PRO2 output channel EQ modes" on page 293.
7	Shelving symbol.
8	Graph of EQ envelope (see "EQ graph" on page 277). When "OFF" is displayed, EQ is switched off.

### GEQ

You can access the output GEQ (shown right) from the EQ processing area of the GUI channel strip.

The GEQ is similar to the ones found in the **Graphic EQs** screen and can also be operated using the assignable controls. For information, see Chapter 15 "Graphic Equaliser (GEQ)" on page 121.



#### >> To open the GEQ window

- 1 Select the output. Its 'overview' display will appear in the channel strip.
- 2 In the GUI channel strip, open the EQ processing area (see "To assign a detail area to the output channel strip via the GUI" on page 46).
- 3 Open the GEQ display (shown right) by clicking **GEQ** in the processing area.
- 4 Open the GEQ screen (shown above right) by clicking on a non-control area of the GEQ image in the processing area.

#### >> To close the GEQ window

- 1 In the GEQ screen (shown above), do one of the following:
  - Click **OK**.
  - Click X at the upper-right corner of the EQ window.
- 2 In the EQ processing area, click **GEQ** to open the outputs overview display.

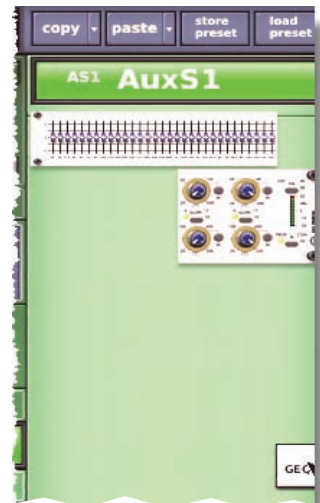

**Navigating the PEQ output bands**

You can change band selection by clicking the **UP/DOWN** buttons in the EQ processing area. This will change selection by one band at a time.

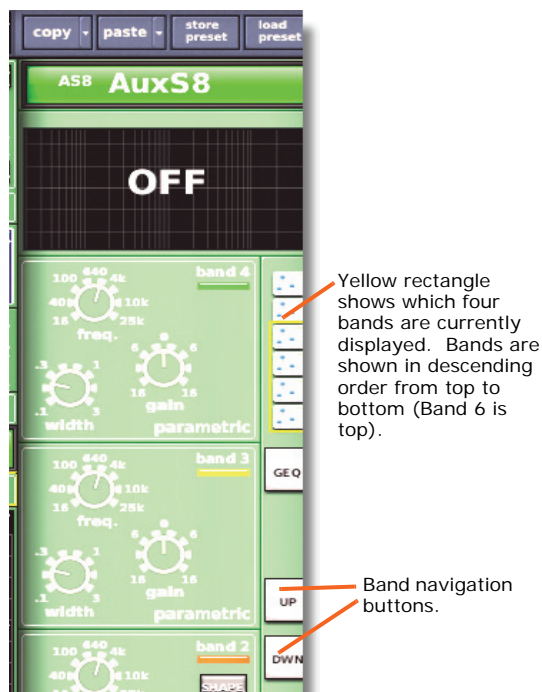

**EQ graph**

The controls in the output EQ sections, that is, the EQ **gain**, **freq** and **width** control knobs, have a similar functionality to the ones in the input EQ sections. For details, see "EQ graph" on page 277.

**What the graph colours represent**

Any combination of EQ envelopes for the four bands can be displayed, and each one is represented by a different colour (as shown right).

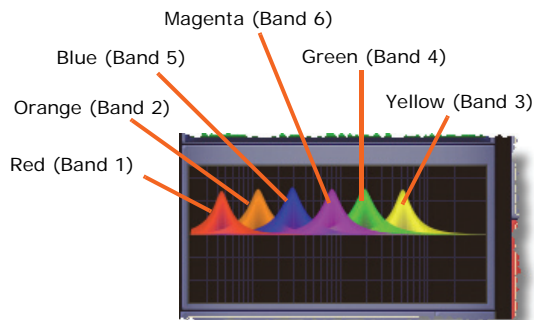

### Mute, safes, level and solo

Each output fast strip (control surface and GUI) has controls for muting, soloing, safes and output signal level control. This is supported on the GUI in the appropriate processing area. They also each have a **SELECT** button for navigation. In addition, the channel strips (control surface and GUI) have the full complement of safes.

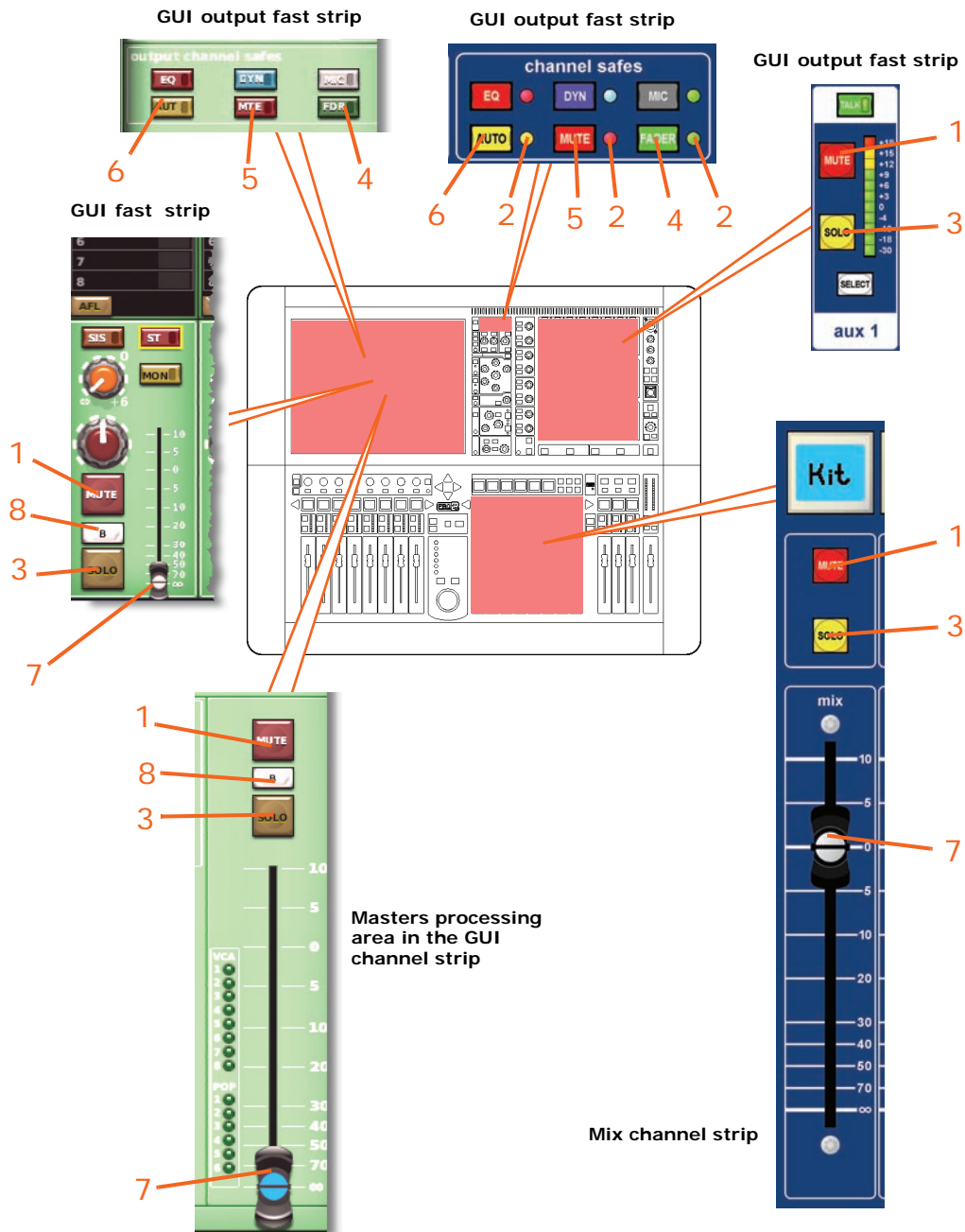

Item	Description
1	<b>MUTE</b> switch, mutes all post-processing signals leaving the channel. (In addition to scene recall, muting can be remote from the auto-mute masters.)
2	Safe LEDs, illuminate when their associated safe is on.
3	<b>SOLO</b> switch, activates signal routing to the monitor A section of the control centre.



<i>Item</i>	<i>Description</i>
4	<b>FADER/[FDR]</b> switch, switches fader safe on so that the fader is removed from scene recall.
5	<b>MUTE/[MTE]</b> switch, switches mute safe on so that mute is removed from the scene recall and auto-mute action.
6	<b>AUTO/[AUT]</b> switch, switches auto safe on so that the channel is removed from scene recall (this does not affect the action of the auto-mutes and VCA control groups) and control is removed from VCA control group faders.
7	Fader for adjusting output signal level. Has the same function as the <b>level</b> control knob (see item 3).
8	Solo <b>B</b> switch (GUI only), changes the operation of the <b>SOLO</b> switch so that it routes signals to the Monitor B section of the control centre.

## Output channel configuration controls

There are a number of output channel controls that are loosely termed 'channel configuration' controls. The following table shows the configuration controls available on each output and references the pertinent section within this chapter.

**Table 13: Output channel configuration controls**

<i>Channel controls</i>	<i>Aux</i>	<i>Matrix</i>	<i>Master</i>	<i>Refer to</i>
<b>Output channel ID</b>	Yes	Yes	Yes	Page 280
<b>Output channel source/destination</b>	Destination	Destination	Destination	Page 280
<b>Stereo linking</b>	Yes	Yes	Yes	Page 280
<b>Mix</b>	Yes	N/A	N/A	Page 280
<b>Link fader</b>	N/A	Yes	N/A	Page 280
<b>Bus trim</b>	Yes	Yes	Yes	Page 280
<b>Direct input</b>	Yes	Yes	Yes	Page 281
<b>Safes (EQ, dynamics, mic, auto, mute and fader)</b>	All six	All six	All six	Page 281
<b>Insert</b>	Yes	Yes	Yes	Page 281
<b>Delay</b>	Yes	Yes	Yes	Page 281
<b>Processing order</b>	Yes	Yes	Yes	Page 281

### Output channel ID (GUI only)

You can change the channel name that appears in the GUI channel strip (see "Text editing" on page 42). This can be done in the **output channel overview** or in any of the processing areas.



You can also change the background colour of the output channel name field, which is done in the **home ▶ Mix & Outputs ▶ Naming Sheet** screen of the GUI menu (see "Configuring VCA/POPulation groups" on page 75).

### Output channel source/destination (GUI only)

The channel's destination is shown in the text field of the configuration processing area. If no destination has been selected, it will contain the text "Unassigned" (as shown right). You can select the destination for this channel by clicking **dest**, which opens the **Patching** screen (see Chapter 8 "Patching" on page 47). For routing information, see Table "Navigating to the Patching screen" on page 16.

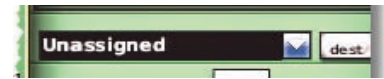

### Stereo linking (GUI only)

The linking section of the configuration processing area has a **LINK** switch for linking the selected output channel to the adjacent (higher numbered) output channel. The **LINK OPT.** button opens a **Stereo Linking Options** window from where you can select which parameters you want to link. For more information, see Chapter 10 "Stereo Linking" on page 95.



### Mix mode (GUI only)

The **mix** section (aux only) has a **MODE** button for scrolling through the three mix modes, that is, mix, mix minus and group.



### Fader linking (GUI only)

The **link fader** section (matrix only), has an **ST** and a **MON** button for linking the matrix channel fader to the stereo or mono master faders, respectively. Control of the stereo master faders reverts to the highest fader.



### Bus trim (GUI only)

The **bus trim** section has a control for fine adjustment of the gain, in the range -12 dB to +6 dB.



## Direct input

The **direct input** section provides an internal connection to effects etc. or an external input into the output from an effect or line I/O unit. It allows you to take a signal directly out of a defined point in the input channel's signal path and route it to either an internal assignable effect or to one of the physical outputs (a physical connection at one of the line I/O boxes). This function is optional and assigned on a channel-by-channel basis.

This section is deliberately distanced from main channel panel controls because it is a limited resource and unused on many channels.

Selection of signal path source can only be carried out via the GUI.

This section has similar functionality to the **direct output** section on each input channel, see "Direct input" on page 281.

For routing information, see Table "Navigating to the Patching screen" on page 16.



## Safes

Each output channel has six types of output channel safes that each protects a specific control/area from the automation system.

You can only operate the safe switches via the channel strips (control surface and GUI), which also provide on/off status information. The status of some of the safes is displayed via LEDs in the output fast strips and master strips on the control surface.

For more information on what areas are protected by each safe, see Appendix H "Parameters Protected By Safes" on page 385.

## Insert (GUI only)

You can configure the send and return points of the aux, matrix and master outputs in the **insert** section of the configuration processing area.

For routing information, see "Navigating to the Patching screen" on page 16.

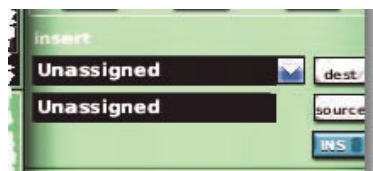

## Output channel delay (GUI only)

Similarly to the input channels, all of the output channels have a delay that can be incorporated into the signal path. However, this can be a much larger delay, being in the range 0ms to 500ms (milliseconds). For details, see "Input channel delay (GUI only)" on page 243.

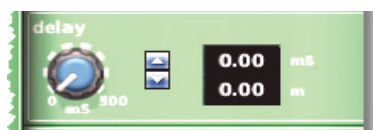

## Processing order

Similarly to the input channels, you can change the processing order on all of the output channels. For details, see "Processing order" on page 247.

## Mixes

Each of the aux and master output channels can send a variable contribution to the mixes on each of the eight matrix buses. The buses are controlled in pairs via mix controls that give continuous adjustment (in the range +6dB to off) of sub group levels sent to matrix mixes. The controls in the **mix** section (mix and master bays) include **level/pan** and **level** control knobs for each bus pair, whose function (auxes only) depends on the current bus mode in operation.

The mixes on the outputs are similar in functionality to inputs, except there is no after fader listen. For details, see "Mixes" on page 259.

## Masters

Towards the bottom of each input fast strip are the **masters** section and pan control, LCD select button, mute and solo, and the input fader.

For each output, the **masters** section (mix and master bays) functions in the same way as for the inputs. For more information, see "Master controls" on page 261.

## Chapter 32: GUI Menu

The GUI is a very powerful multi-functional tool that forms the core of the PRO2 Control Centre. It gives you total control and monitoring of the operating environment, enhances control surface operation (you can even operate the PRO2 by GUI-only) and allows the use of internal and external devices. To facilitate this the GUI incorporates a simple-to-use GUI menu.

The GUI menu presents you with a list of options from which to choose, depending on your requirement. The following lists some of the functions that the GUI menu provides:

- **Configuration** Configure the routing, associations and the names and colours of channels, groups, graphic EQs and internal effects, set up for multi-console operation, set up the connected devices etc.
- **Navigation** Select the channels, buses and groups you want, go quickly to a GUI screen display, go to recently opened screens, move through the scenes in a show and go to the patching screens you want.
- **Management** Manage show files (internal and external), automation and the monitoring system.
- **User and operating preferences** Adjust GUI screen brightness and contrast, select delay compensation, select fader flip etc.
- **Information** View current software information.
- **Security** Lock the screens to prevent unauthorised access.
- **Shutdown sequence** Shut down the control centre properly.
- **Upgrading the software** Install the very latest version (or any previous version) of PRO2 software.

For details of how to access the GUI menu, see "Using the GUI menu" on page 42.

### GUI menu flowchart

The GUI menu and all of its available submenus are shown in Figure 28 “GUI menu flowchart” on page 284.

Icons to the left of the options help to identify the option type and aid navigation. A black triangle to the right of a menu option shows that it has a submenu.

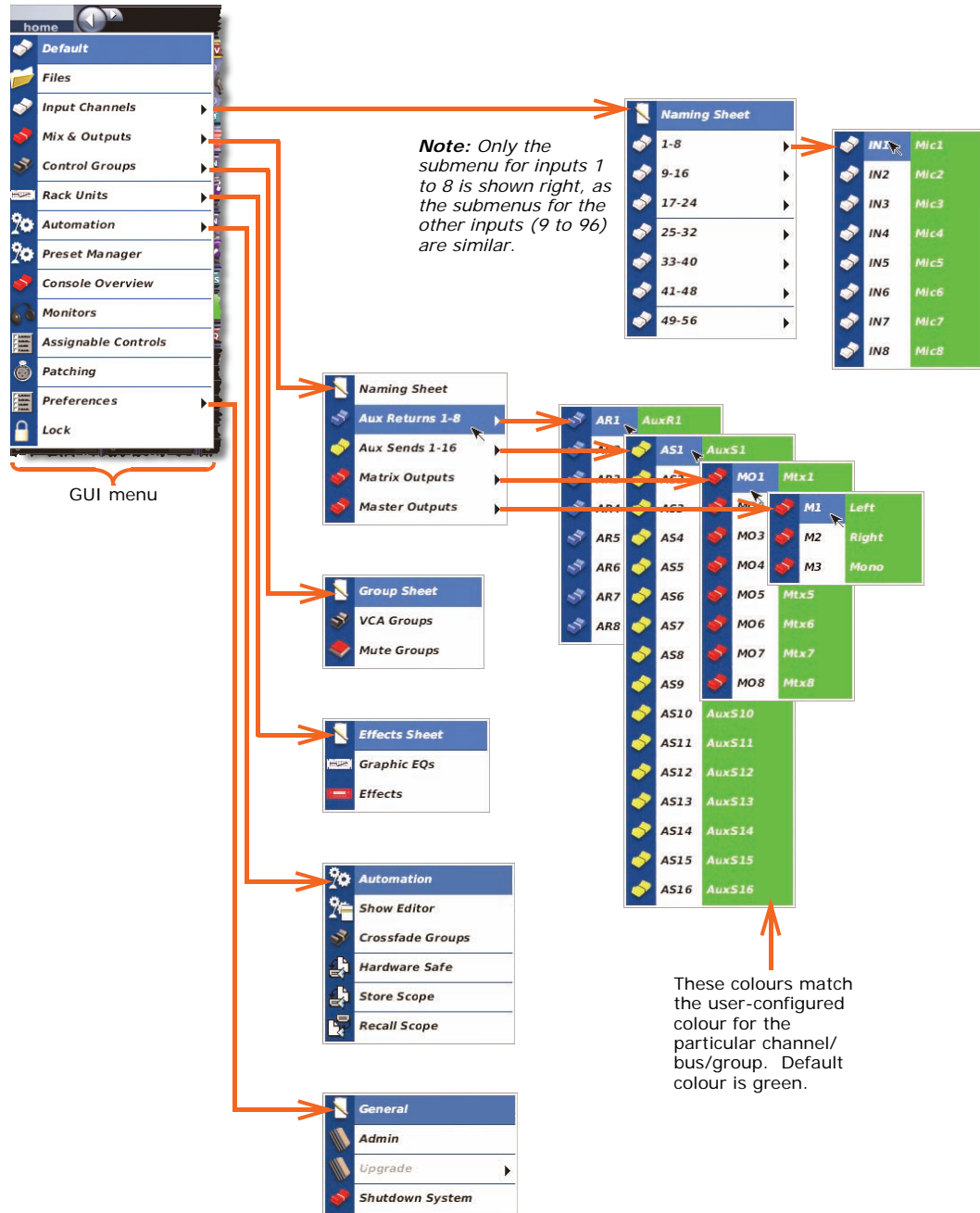

Figure 28: GUI menu flowchart

## GUI menu options

When you open the GUI menu, you are presented with a main list of options that open specific screens or submenus, as shown in the following table. You can access some of the screens directly from the **screen access** buttons in the navigation zone (see “PRO2 control surface” on page 18).

<i>Option</i>	<i>Description/function</i>
<b>Default</b>	Opens the default display.
<b>Files</b>	Opens the <b>Files</b> screen (see “Managing show files on the Files screen” on page 173).
<b>Input Channels</b>	Input channel option, which opens a submenu with the following options: <ul style="list-style-type: none"> <li>• <b>Naming Sheet</b> — lets you configure the 56 input channels (see “Configuring the channels, groups and internal units” on page 213).</li> <li>• <b>1-8</b> through to <b>49-56</b> — click one to open the associated bank of inputs, or open the submenu. Each submenu contains the eight single inputs belonging to its bank; click on one to select its channel.</li> </ul>
<b>Mix &amp; Outputs</b>	Output channel option, which opens a submenu with the following options: <ul style="list-style-type: none"> <li>• <b>Naming Sheet</b> — lets you configure the output channels (see “Configuring the channels, groups and internal units” on page 213).</li> <li>• Output channel options — click one to open the associated bank of outputs (returns, auxes, matrices or masters), or open the submenu.</li> </ul>
<b>Control Groups</b>	Control groups (VCA/POPulation, auto-mute and talk) option, which opens a submenu with the following options: <ul style="list-style-type: none"> <li>• <b>Group Sheet</b> — lets you configure each group (see “Configuring the channels, groups and internal units” on page 213).</li> <li>• <b>VCA Groups</b> — click to open the VCA Groups screen, or open the submenu, which contains an option each for the 12 VCA groups and eight POPulation groups; click on one to select its group. See “VCA and POPulation groups” on page 143.</li> <li>• <b>Mute Groups</b> — click to open the <b>Mute Groups</b> screen (see “Auto-mute (mute) groups” on page 147).</li> </ul>
<b>Rack Units</b>	Control groups (VCA/POPulation, auto-mute and talk) option, which opens a submenu with the following options: <ul style="list-style-type: none"> <li>• <b>Effects Sheet</b> — lets you configure each of the 16 GEQ and 16 internal effect ‘virtual’ rack units (see “Configuring the channels, groups and internal units” on page 213).</li> <li>• <b>Graphic EQs</b> — opens the <b>Graphic EQs</b> screen (see “About the Graphic EQs screen” on page 121).</li> <li>• <b>Effects</b> — opens the <b>Effects</b> screen (see “Overview of the internal effects” on page 127).</li> </ul>

<i>Option</i>	<i>Description/function</i>
<b>Automation</b>	Automation option, which opens a submenu with the following options: <ul style="list-style-type: none"> <li>• <b>Automation</b> — opens the <b>Automation</b> screen (see Chapter 20 "Scenes And Shows (Automation)" on page 161).</li> <li>• <b>Show Editor</b> — opens the <b>Show Editor</b> screen (see "Show editor" on page 86).</li> <li>• <b>Crossfade Groups</b> — opens the <b>Crossfade Groups</b> screen (see "Crossfade groups" on page 195).</li> <li>• <b>Hardware Safe</b> — opens the <b>Hardware Safe</b> screen (see "Safes" on page 174).</li> <li>• <b>Store Scope</b> — opens the <b>Store Scope</b> screen (see "Using store scope" on page 183).</li> <li>• <b>Recall Scope</b> — opens the <b>Recall Scope</b> screen (see "About the Recall Scope screen" on page 177).</li> </ul>
<b>Preset Manager</b>	Opens the <b>Preset Manager</b> screen (see Chapter 24 "User Libraries (Presets)" on page 199).
<b>Console Overview</b>	Opens the <b>Console Overview</b> screen (see "Input metering" on page 241).
<b>Monitors</b>	Opens the <b>Monitors</b> screen (see Chapter 14 "Monitors And Communications" on page 109).
<b>Assignable Controls</b>	Opens the <b>Assignable Controls</b> window (see Chapter 19 "Assignable Controls" on page 153).
<b>Patching</b>	Opens the <b>Patching</b> screen (see Chapter 8 "Patching" on page 47).
<b>Preferences</b>	Preferences option, which opens a submenu with the following options: <ul style="list-style-type: none"> <li>• <b>General</b> — opens the <b>Preferences</b> screen (see Chapter 27 "Changing The Preferences" on page 207).</li> <li>• <b>Admin</b> — opens the administrator's window. This is a supervisor-only function, which is accessed by typing in a password.</li> <li>• <b>Upgrade</b> — opens a list of TAR files from which to choose when updating the PRO2's software (see "Updating your system" on page 332).</li> <li>• <b>Shutdown System</b> — opens the shutdown message window, which initiates an expedient shutdown of the PRO2 (see "To switch off the PRO2 Control Centre" on page 31).</li> </ul>
<b>Lock</b>	Locks the GUI (see "Security (locking mode)" on page 92).



# *Appendices*



## Appendix A: Application Notes

This chapter provides more in-depth information on certain areas and function of the PRO2.

### Spatial imaging system (SIS™)

Although conventional consoles can be used for three-channel mixing, the methods for doing so are complicated and unorthodox. This forces the engineer to work in unaccustomed ways, limiting creative flexibility, and making use by visiting operators impractical. The spatial imaging system (SIS™) has been developed to overcome this.

Backing vocalists can be panned slightly towards the centre cluster to improve intelligibility, while keeping the featured vocal 'front and centre'.

Musical instruments can be placed in a conventional mix then easily switched to the centre for solos.

In theatrical productions, SIS™ allows you to pan an actor's voice across three channels following their on stage movements. In stereo-only productions, the centre output can be used to provide a mono-to-mix-base feed activating a single 'left + right to centre' switch.

The ability of SIS™ to feed centre-panned signals equally to both left and right outputs, as well as the centre, is particularly useful for distributing the load of high energy, centre-panned sounds across all FOH loudspeaker arrays.

### PRO2 compressor modes (dynamic)

This section aims to provide an understanding of the compressor modes contained within the PRO2 Control Centre.

#### Description

The PRO2 compressors have five primary operating modes (only four on inputs). These change the signature (or shape) of the attack and release envelope curves, interactions and timings. Before dealing with this in detail, some of the generic terms are defined and explained:

#### **Threshold**

The threshold adjusts the operating point of the compressor. Signals that go over this point, or *over-threshold*, will be affected by compressor action. Signals that stay below threshold will not trigger any compression although they may still be affected by compression releases from previous over threshold signals.

#### **Ratio**

The compression ratio control provides control of the amount of compression that is applied to over-threshold signals. This is expressed as a ratio of signal level changes from input to output. For example, when the compressor is set to 2:1, every 2dB input level change will only generate a 1dB output level change (assuming the signal levels are over threshold).

**Attack**

The attack control adjusts the time taken for the compressor to respond to an over-threshold signal. The shape of the attack can be selected from one of the five mode combinations mentioned above, making the compressor easily adaptable for a wide number of creative and corrective applications.

**Release**

The release control adjusts the time the compressor takes to recover after the programme material falls back below threshold. Both attack and release also respond to changes in programme level that remain over-threshold. For example, a signal that reduces in level but remains above threshold will still trigger a release, but in this case it will only be a partial release - because the compressor will still be required to generate gain reduction, but now, as appropriate for the new lower signal level.

**Knee**

Most compression sounds more natural in soft knee mode. Soft knee compression blurs the distinction between over-threshold and under-threshold signals, such that signals that are a long way below threshold remain unaffected by compression, and signals that near the threshold get compressed, but at greatly reduced ratios. When signals are just over-threshold the compressor ratios are still somewhat reduced; it is only when signals go well over threshold that the full ratio compression is applied. When using a harder knee setting the compressors operate in a more clinical way with a more defined transition between under-threshold and over-threshold; this is better suited to limiting style compression.

**Gain**

The gain control provides adjustment of the *make up* gain so that the level of the outgoing compressed signal can be matched to the incoming uncompressed signal.

**Side chain filter**

A band pass filter is provided that acts on the side chain signals. This can be used to make the compression frequency selective. The controls for this are frequency, adjustable from 50Hz to 15KHz, and bandwidth selectable as wide, medium or narrow. Additionally, there is a listen function that places the filtered side chain onto the solo bus and a side chain filter in to activate or eliminate the filter action.

**Compressor envelope modes**

The five envelope *modes*, or *signatures*, are the key to the sonic character of the PRO2 compressors, and they allow adjustment far beyond the normal capabilities of simple attack and release settings. They largely fall into two application types:

- 1 Compressors that are good at capturing and controlling dynamic transients: corrective mode and vintage mode.
- 2 Compressors that emphasise dynamic transients and provide creative control of levels within a mix: adaptive, creative and shimmer modes.

The Vintage and Adaptive compressors tend to morph a little between these two categories depending on threshold control settings. This makes them easy to use intuitively with minimal fine-tuning of the envelope control settings.

Further refinement and enhancement of the envelope modes is provided by combination settings of the three-position **KNEE** switch. It is best to understand the operation of these two functions in more depth before looking at the detail of the compressor signature switching.

### ***Knee***

The soft knee curves behave in a traditional way to blend the compression ratio around the threshold setting (as described above), but more importantly they also have a significant effect on the attack envelope shapes. The soft knee typically slows down attack speed on signals in the knee area, which is desirable for natural sounding compression because it compliments the reduced ratio effect of the soft knee. This produces very gentle compression in the knee region.

The **KNEE** switch has three settings: hard (4dB); medium (12dB); and soft (40dB). In hard setting the compressor still retains some soft knee characteristics. This is because the implementation of an extremely hard knee produces undesirable sounding distortion on low frequency programme material.

### ***Corrective mode (exponential peak - fast)***

This is a peak sensing compressor (like many older designs) with exponential attack and release. It produces aggressive compression that gives good fast control and/or limiting of dynamic material. It can be used to add colour to low frequency signals making it ideal for controlling extremely dynamic instruments like the bass guitar. The compressor tends to sound best with fast attack time settings that capture transients and with release adjusted to taste to either emphasise or minimise distortion and pumping effects.

### ***Adaptive mode (exponential RMS - accurate)***

This is a root-mean-square (RMS) sensing compressor with exponential attack and release. The RMS averaging process interacts with the attack and release to produce a very adaptive envelope character. This allows faster attacks on large (over-threshold) signal changes and produces slower attacks on small signal changes, regardless of attack time setting. The attack control is still active, allowing some user intervention although the adaptive nature makes envelope control setting fairly non-critical. The compressor is therefore very fast and simple to set up on most programme material. It is also sonically accurate and works well for both compression and limiting of vocals and many other sources. The most natural sounding compression is normally achieved with *soft knee* settings.

### ***Creative mode (linear peak - slow)***

This is a peak sensing compressor with linear (dB rate) attack and second order release. The compressor is very transparent, providing some dynamic control but without unduly affecting the intentional dynamic content of the source material. The linear attack provides a constant rate of attack, such that large changes in programme signal level take longer to become compressed than smaller changes. Adding *soft knee* noticeably delays these attacks, which can be particularly useful on drums where compression can be applied to emphasise transients giving more punch while retaining a good deal of artistic dynamic from the drummer.

The compressor normally sounds best with slower attack time settings, when it can be used on difficult instruments, such as the acoustic guitar, with relatively fast release to keep equal perceived loudness within a mix without producing excessive flutter or distortion.

### ***Vintage mode (adaptive peak - bright)***

This is a peak sensing compressor with a partially adaptive nature. It produces extremely subtle attack and release curves during the onset of compression that are largely independent of the envelope control settings. However, as it is driven harder, that is, signals are further over-threshold, the attack and release times become more aggressive and gradually return to manual control so the operator can optimise the capture (or otherwise) of larger transients etc. The peak sensing algorithm intentionally increases harmonic overtones during compression, which adds a *valve-like*

brightness and sparkle to the programme, producing extremely natural and lively sounding compression of acoustic instruments.

***Shimmer mode (overshoot peak - slow) - output only***

This is a peak sensing compressor with an exponential release and unusual second order attack character that tends to *overshoot*.

If used sparingly, the compressor sounds very soft and natural and can provide additional control of material that already has a fairly low dynamic content. It can sound very transparent on vocals where it retains a good degree of life in the performance.

If used at higher ratios with slow attack and fast release times, the compressor can produce a very soft bouncy sound character.

## PRO2 input channel EQ modes

This section aims to provide an understanding of the input channel EQ modes contained within the PRO2 control centre.

### Basic specification

The PRO2 input EQ comprises four bands: treble; hi mid; lo mid; and bass. The default operation for all four sections is full parametric sweep (peak), with the following controls:

- **Gain:** continuous adjustment of boost and cut from + 16dB to - 16dB.
- **Width:** continuous adjustment of bandwidth from 0.1 to 3.0 octaves (this only operates in parametric mode for Bass and Treble).
- **Treble:** continuous adjustment of the frequency range that the treble equaliser acts on from 1kHz to 25kHz.
- **Hi mid and lo mid:** hi mid frequency control gives continuous adjustment of the frequency range that the hi mid equaliser acts on from 320Hz to 8kHz. Lo mid frequency control gives continuous adjustment of the frequency range that the lo mid equaliser acts on from 80Hz to 2kHz.
- **Bass:** continuous adjustment of the frequency range that the bass equaliser acts on from 16Hz to 400Hz.

The treble EQ band can be switched from parametric to any of three other shelving modes: Soft; Classic; and Bright.

The bass EQ band can be switched from parametric to any of three other shelving modes: Warm; Classic; and Deep.

### Description

The difference between the shelf filters is subtle and, if you do not have time to experiment, it is probably best to use classic because this is the best all round filter. However, when you do have time to experiment you may find the other types each have their uses. The minimum harmonic types, and in particular the bass, can sound very natural, even with very aggressive EQ, but the psycho-acoustic principles that they operate on do not always work so well on multiple source or pre-mixed material.

***Soft treble***

The soft treble response provides a very gentle gradient between EQ'd and non-EQ'd frequency areas. This produces the absolute minimum of phase shift but does not provide much differentiation, thus frequencies outside the area of interest are often unintentionally EQ'd. This is best used to provide gentle shaping of pre-mixed material.

***Classic treble***

The classic treble response provides a much steeper gradient between EQ'd and non-EQ'd frequency areas, as made famous by previous Midas consoles like the XL4. This provides better differentiation and minimal phase shift, but there is some undershoot error, that is, when boosting the treble, the mids are slightly cut and vice versa. This is the best all round EQ and especially effective when microphones are covering multiple sources.

***Bright treble***

The bright treble response provides a slightly steeper gradient than the classic and it is uniquely shaped to provide minimum harmonic disruption to the EQ'd material. As for the classic EQ, this provides better differentiation and minimal phase shift, but now there is no undershoot error corrupting the mids. This is best used on single source material and especially good for acoustic performances.

***Warm bass***

The warm bass response provides a very gentle gradient between EQ'd and non-EQ'd frequency areas. This produces the absolute minimum of phase shift, but does not provide much differentiation, thus frequencies outside the area of interest are often unintentionally EQ'd. This is best used to provide gentle shaping of pre mixed material.

***Classic bass***

The classic bass response provides a much steeper gradient between EQ'd and non-EQ'd frequency areas and is modelled on the XL4. This provides better differentiation and minimal phase shift, but there is some undershoot error, that is, when boosting the bass, the mids are slightly cut and vice versa. This is often desirable on bass EQ and it is the best all round, general purpose EQ curvature.

***Deep bass***

The deep bass response provides a slightly steeper gradient than the classic and it is uniquely shaped to provide minimum harmonic disruption to the EQ'd material. As for the classic EQ, this provides better differentiation and minimal phase shift, but there is no undershoot error. Powerful boost/cut can be used that still sounds very natural and does not corrupt the mids. This is best used on single source material.

## PRO2 output channel EQ modes

This section aims to provide an understanding of the output channel EQ modes contained within the PRO2 control centre.

### Basic specification

The PRO2 output EQ comprises six bands strategically positioned at certain frequencies ranging from the low end (bass) to the high (treble) of the frequency band. The default operation for all six sections is full parametric sweep (peak), with the following controls:

- **Gain:** continuous adjustment of boost and cut from + 16dB to - 16dB.
- **Width:** continuous adjustment of bandwidth from 0.1 to 3.0 octaves.
- **Frequency:** continuous adjustment of the frequency range that the band EQ acts on from 16Hz to 25kHz.

Band 1 can be switched from parametric to any of three shelving modes: warm; high pass filter 6dB; and high pass filter 12dB.

Band 2 can be switched from parametric to high pass filter 24dB.

**Note:** When the 24dB/octave high pass filter is selected in band 2, band 1 becomes inaccessible.

Band 6 can be switched from parametric to any of three shelving modes: soft; lo pass filter 6dB; and lo pass filter 12dB.

## Description

### ***Soft (treble)***

The soft treble response provides a very gentle gradient between EQ'd and non-EQ'd frequency areas. This produces the absolute minimum of phase shift but does not provide much differentiation, thus frequencies outside the area of interest are often unintentionally EQ'd. This is best used to provide gentle shaping of pre-mixed material.

### ***Warm (bass)***

The warm bass response provides a very gentle gradient between EQ'd and non-EQ'd frequency areas. This produces the absolute minimum of phase shift, but does not provide much differentiation, thus frequencies outside the area of interest are often unintentionally EQ'd. This is best used to provide gentle shaping of pre mixed material.

### ***High pass filter (HPF)***

The HPF attenuates (not boosts) all frequencies below a certain level (cut-off frequency) while allowing all those above it to pass through. The harshness or smoothness with which the sound is removed beyond this point is determined by the dB/octave, with 6dB being the most common. The HPF is generally used to take rumble or hum out of any sound source, but may also produce a sound effect by manipulation of the controls.

The PRO2's high pass filters have gain roll off before the corner frequency, which is variable.

### ***Lo pass filter (LPF)***

The LPF attenuates (not boosts) all frequencies above a certain level (cut-off frequency) while allowing all those below it to pass through. The harshness or smoothness with which the sound is removed beyond this point is determined by the dB/octave, with 6dB being the most common. The LPF is generally used to reduce noise in quiet passages or to take the *fizz* off any source with excessively high frequencies, but may also produce a sound effect by manipulation of the controls.

The PRO2's low pass filters have gain roll off after the corner frequency, which is variable.



## ***Appendix B: Functional Block Diagrams***

This chapter contains the PRO2 signal path diagrams.

# Mono input channel signal flow

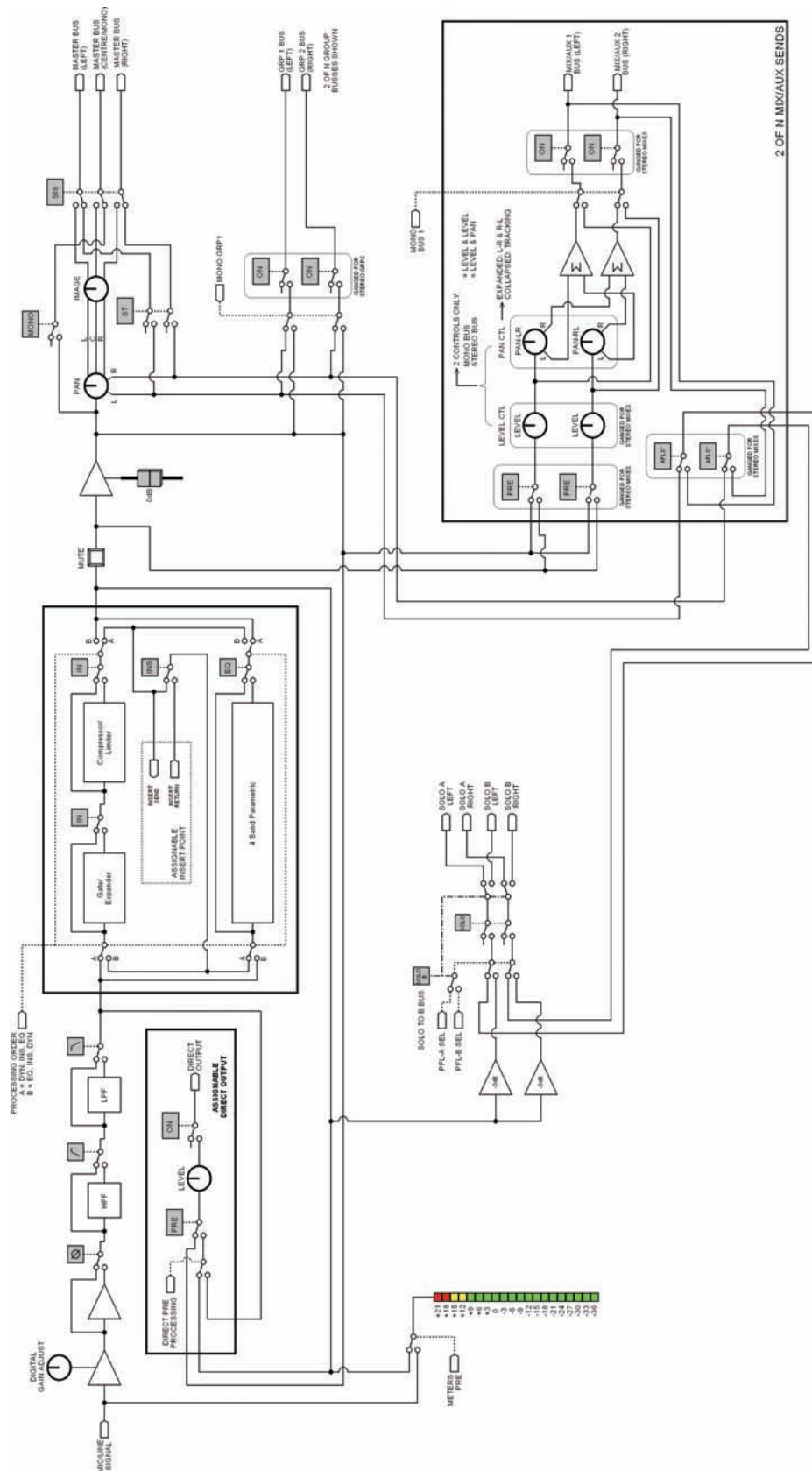

# Returns signal flow

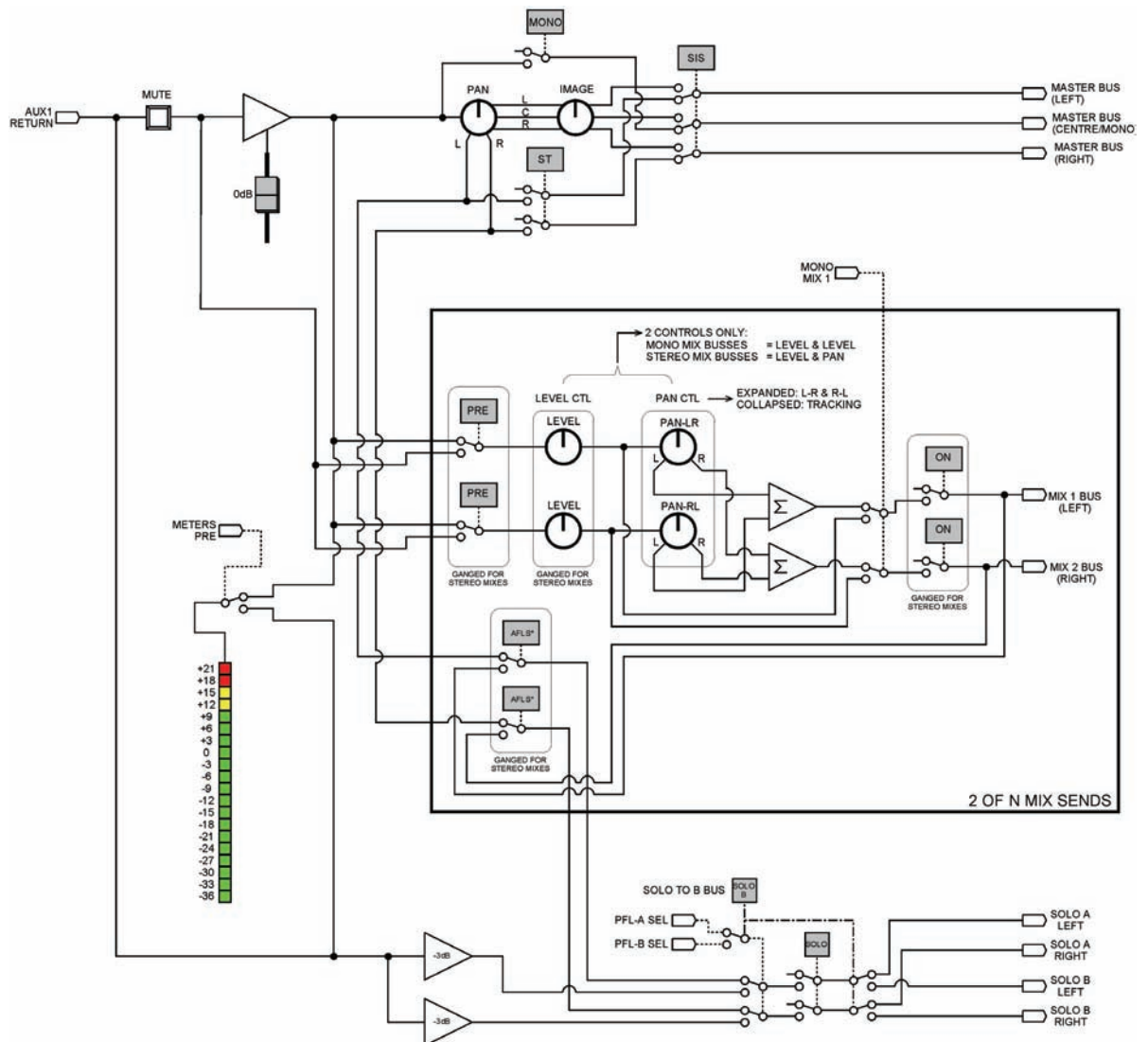

# Aux/group signal flow

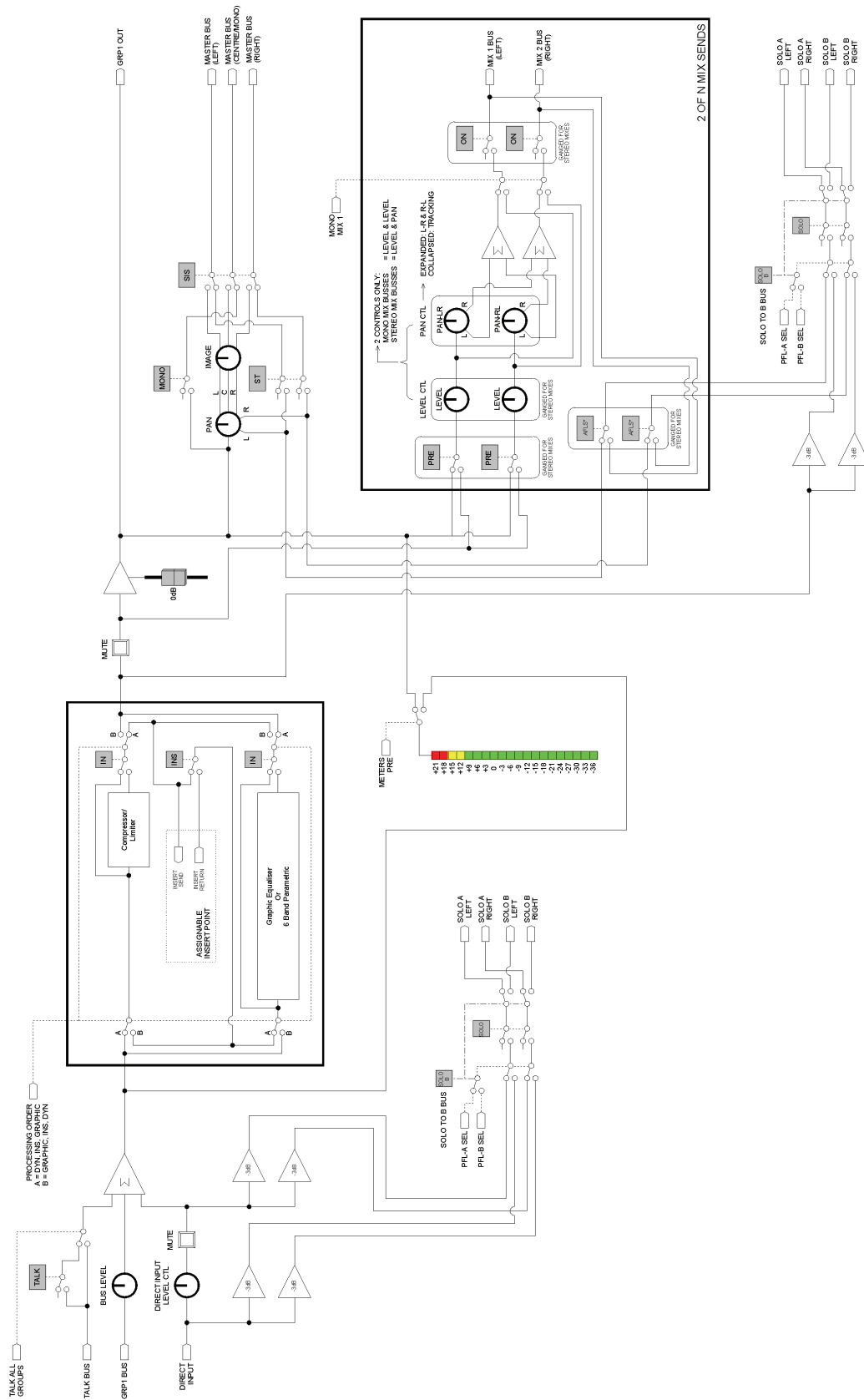

# Master signal flow

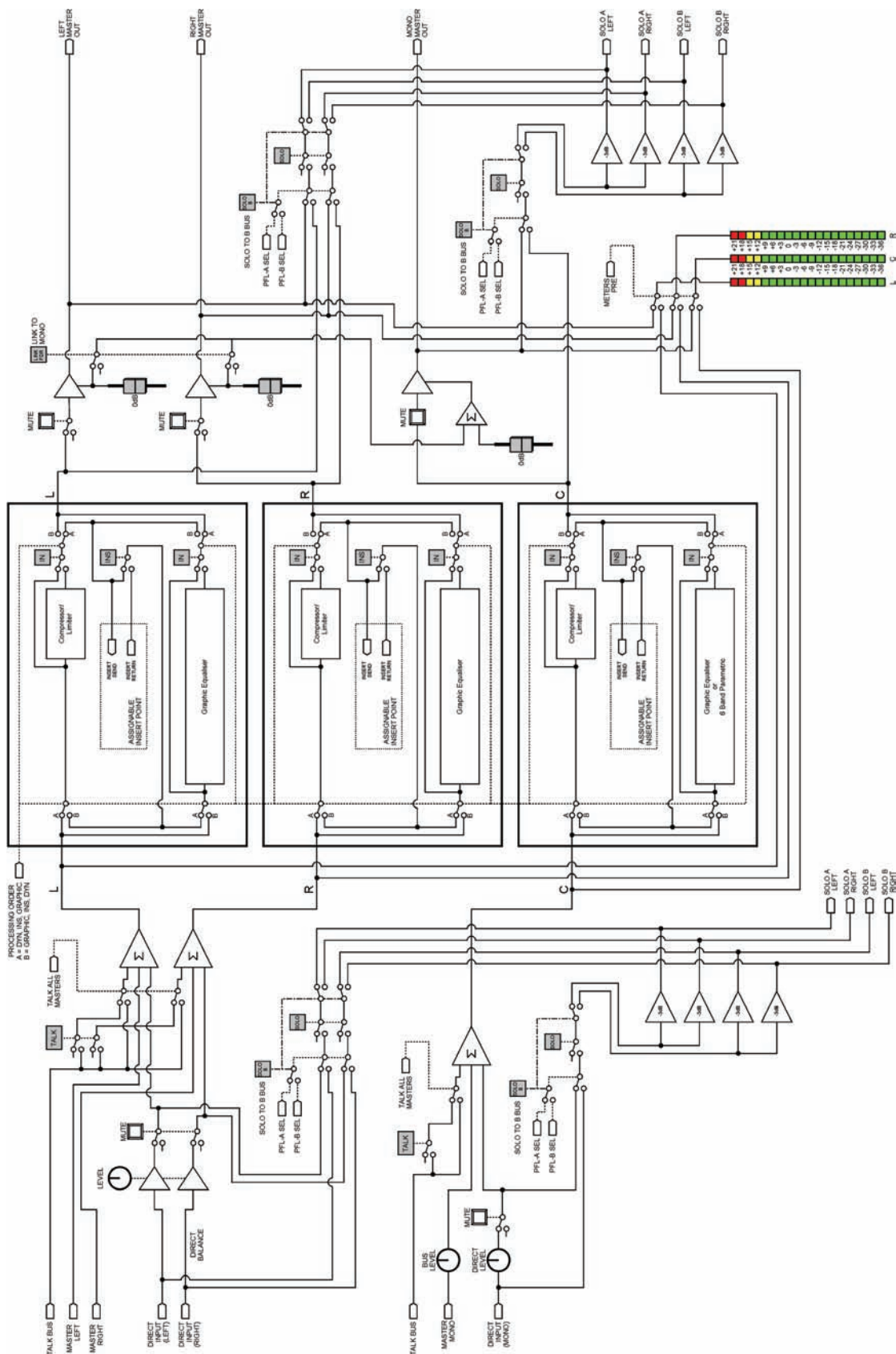

# Mono mix signal

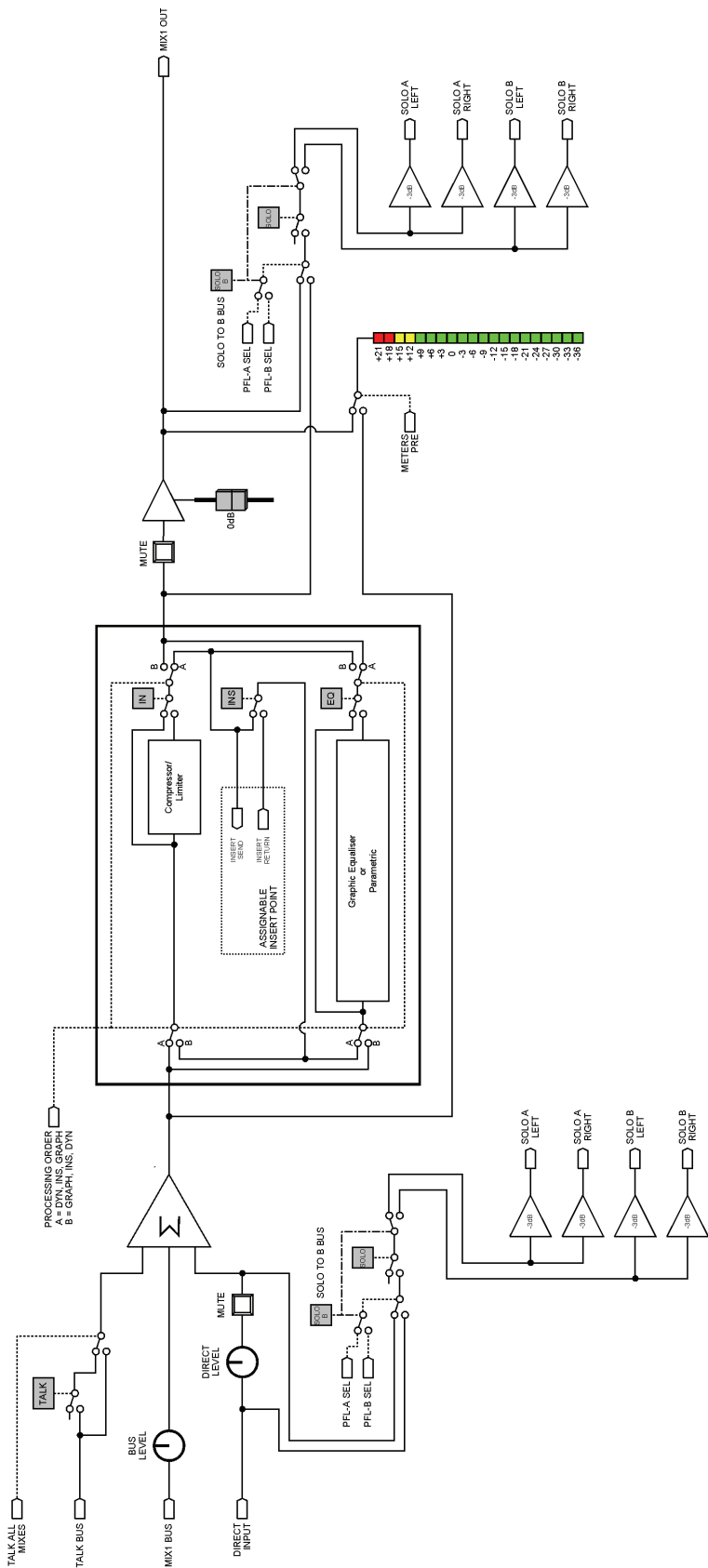

# Monitor signal flow

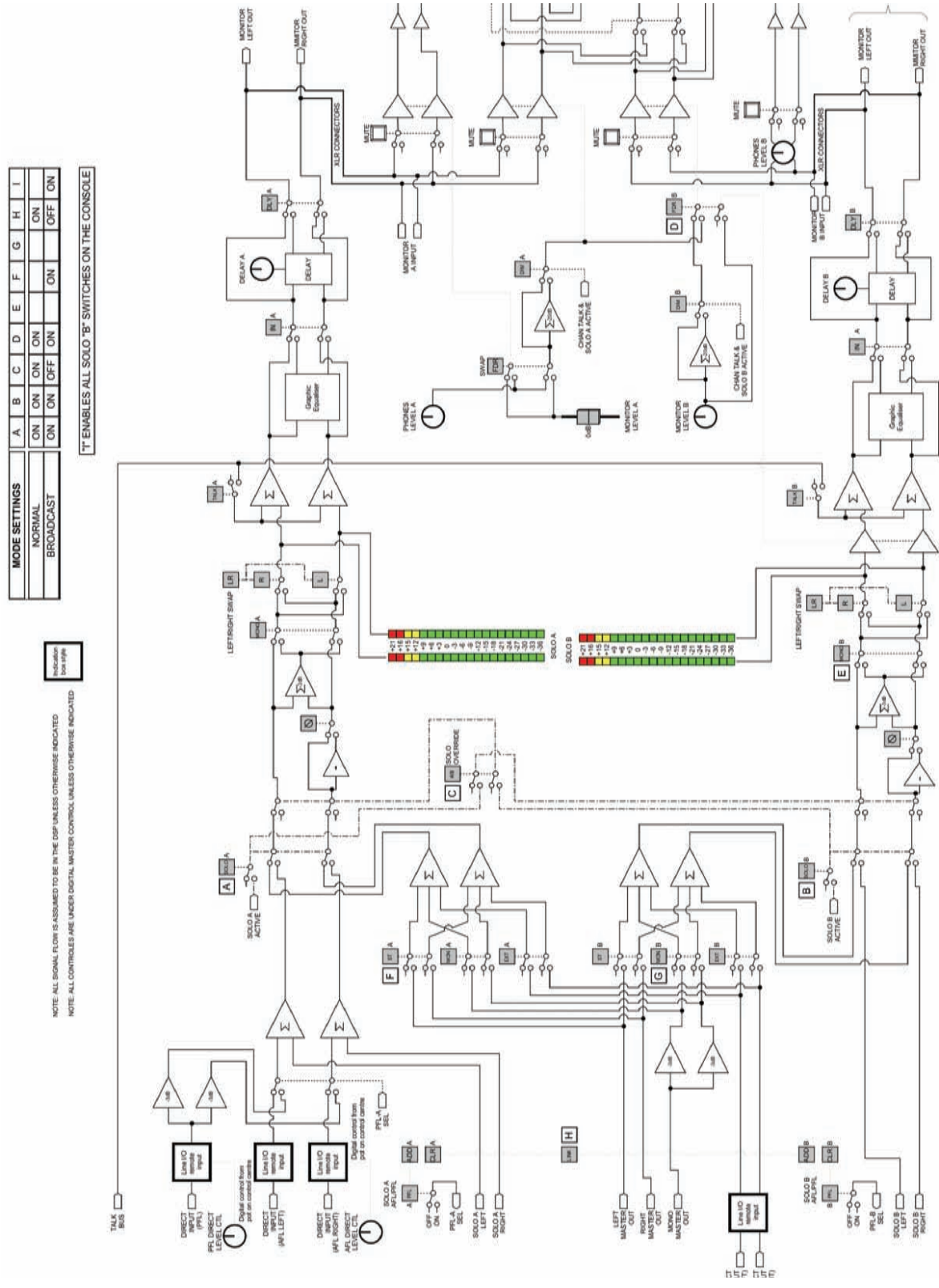

MODE SETTINGS		A	B	C	D	E	F	G	H	I
NORMAL		ON	ON	ON	ON	ON	ON	ON	ON	ON
BROADCAST		ON	OFF	ON	ON	ON	ON	ON	OFF	ON

'T' ENABLES ALL SOLO 'B' SWITCHES ON THE CONSOLE

NOTE: ALL SIGNAL FLOW IS ASSUMED TO BE IN THE DSP UNLESS OTHERWISE INDICATED  
 NOTE: ALL CONTROLS ARE UNDER DIGITAL MASTER CONTROL UNLESS OTHERWISE INDICATED



# Comms signal flow

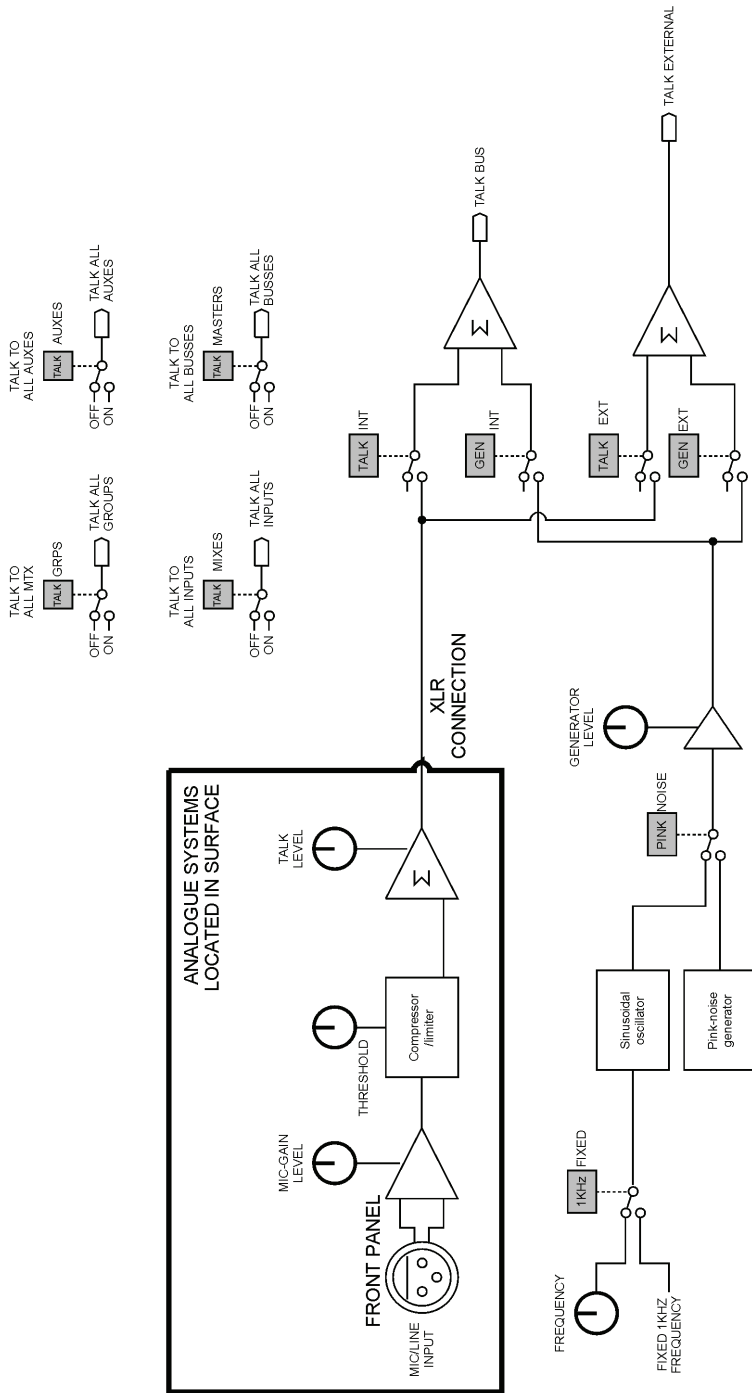



# Dynamics signal flow

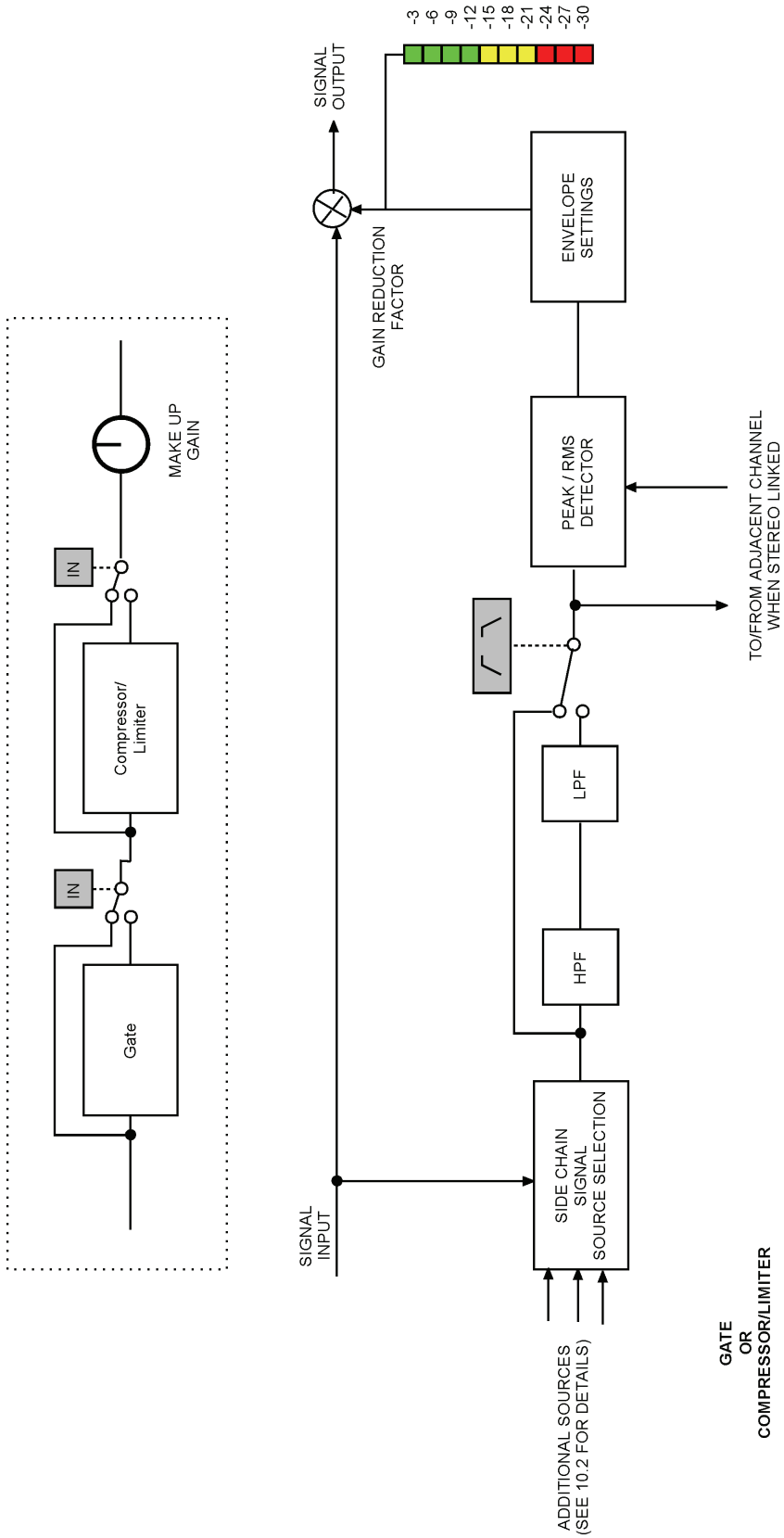



## Appendix C: Technical Specification

This appendix provides the full technical specification for the PRO2 Live Audio System, which includes the DL251 Audio System I/O.

© 2011 MUSIC Group IP Ltd. Technical specifications and appearances are subject to change without notice and accuracy is not guaranteed. MIDAS and KLARK TEKNIK are part of the MUSIC Group (music-group.com).

### PRO2 general statistics

<b>XLR connections</b>	<p>1 x 5U rack I/O box houses:</p> <ul style="list-style-type: none"> <li>• 48 x (XLR) mic/line inputs</li> <li>• 16 x (XLR) line outputs</li> </ul> <p>Control surface houses:</p> <ul style="list-style-type: none"> <li>• 8 x (XLR) outputs</li> <li>• 8 x (XLR) line outputs</li> <li>• 4 x (XLR) monitor outputs</li> <li>• 2 x (XLR) master outputs</li> <li>• 2 x (XLR) AES3 stereo outputs</li> <li>• 2 x (XLR) AES3 stereo inputs</li> <li>• 1 x (XLR) talk output</li> <li>• 1 x (XLR) talk input</li> </ul>
<b>System expansion</b>	<p>Multiple 3U rack configurable I/O boxes (optional DL451 rack boxes) can be connected that house 24 x I/O slots in 8 x 8 wide blocks of:</p> <ul style="list-style-type: none"> <li>• 8 x (XLR) mic/line inputs or</li> <li>• 8 x (XLR) line outputs or</li> <li>• 8 x (Jack) line in and 8 x line out</li> <li>• 4 x (stereo) AES3 in and 4 x (stereo) AES3 out</li> </ul> <p>Multiple 6U rack splitters (optional DL431) house:</p> <ul style="list-style-type: none"> <li>• 24 x splitter mic/line inputs</li> <li>• 2 x 24 splitter outputs</li> <li>• 1 x 24 transformer isolated splitter outputs</li> </ul>
<b>Input audio processing</b>	<p>56 x dual slope high and low pass filters  56 x 4-band parametric EQs with 3 shelf modes  56 x 4-mode creative input compressors  56 x input gates</p>
<b>Mix/output audio processing</b>	<p>24 x output 6-band parametric EQs with shelf and multiple high and low pass modes  24 x 5-mode creative output dynamics  8 x assignable Klark Teknik output GEQs</p>
<b>Assignable audio processing</b>	<p>4 x assignable stereo effects (each of these can be reconfigured to generate 4 further GEQs, making a total of 24 available on the console)</p>

<b>Mixing control assistance</b>	6 x auto-mutes 6 x surface POPulation groups 8 x VCA faders 8 x VCA associated POPulation groups 176 x MCA faders 176 x flipped MCA POPulation groups 1000-scene snapshot automation
<b>Resilience</b>	N+1 cable redundancy and dual redundant PSUs

## PRO2 general specifications

<b>Sampling frequency</b>	96kHz
<b>Latency delay</b>	<2ms input to master (no compensation)
<b>Dynamic range</b>	106dB, 22Hz to 22kHz (no pre-emphasis)
<b>Maximum voltage gain</b>	80dB inputs to subgroups and masters 86dB inputs to aux and matrix
<b>Crosstalk at 1kHz</b>	-100dB physically adjacent input channels
<b>Crosstalk at 10kHz</b>	-90dB physically adjacent input channels
<b>Fader/pan cut off at 1kHz</b>	-100dB
<b>Fader/pan cut off at 10kHz</b>	-100dB
<b>Display screens</b>	1 x 15" daylight-viewable colour screen
<b>LCD switch</b>	25 x RGB colour
<b>Motorised faders</b>	20 x touch-sensitive
<b>Fader resolution</b>	1024 steps
<b>Encoders</b>	31 x touch-sensitive
<b>Encoder resolution</b>	512 steps
<b>Dimensions</b>	PRO2 control centre: 1179.6 mm wide x 730.3 mm deep (46.44" x 27.75") PRO2C control centre: 882 mm wide x 730.3 mm deep (34.72" x 28.75") DL251 I/O box: 5U x 200 mm deep
<b>Net weight*</b>	PRO2 control centre: 40 kg PRO2C control centre: 37 kg 1 x DL2531: 10 kg
<b>Power requirements</b>	100V to 240V a.c. $\pm 10\%$ , 50 to 60Hz
<b>Operating temperature range</b>	+5°C to +45°C
<b>Storage temperature range</b>	-20°C to +60°C

\* Weights are approximate and out of flight case.

## PRO2 audio performance specifications

### Frequency response

<i>Input</i>	<i>Output</i>	<i>Gain</i>	<i>20Hz</i>	<i>20kHz</i>
DL251 I/O box	DL251 I/O box	0dB	0dB to -1.0dB	0dB to -1.0dB
DL251 I/O box	DL251 I/O box	40dB	0dB to -1.0dB	0dB to -1.0dB
Surface I/O	Surface I/O	0dB	0dB to -1.0dB	0dB to -1.0dB
Surface I/O	Surface I/O	40dB	0dB to -1.0dB	0dB to -1.0dB
DL451 I/O box	DL451 I/O box	0dB	0dB to -1.0dB	0dB to -1.0dB
DL451 I/O box	DL451 I/O box	40dB	0dB to -1.0dB	0dB to -1.0dB
DL431 splitter	DL351 I/O box	0dB	0dB to -1.0dB	0dB to -1.0dB
DL431 splitter	DL351 I/O box	40dB	0dB to -1.0dB	0dB to -1.0dB
DL431 splitter	DL431 A out	0dB	0dB to -0.5dB	0dB to -0.5dB
DL431 splitter	DL431 A out	40dB	0dB to -0.5dB	0dB to -0.5dB
DL431 splitter	DL431 B out	0dB	0dB to -0.5dB	0dB to -0.5dB
DL431 splitter	DL431 B out	40dB	0dB to -0.5dB	0dB to -0.5dB
DL431 splitter	DL431 C out	-6dB	0dB to -1.0dB	0dB to -1.0dB

### Gain error at 1kHz

<i>Input</i>	<i>Output</i>	<i>Gain</i>	<i>Maximum</i>	<i>Minimum</i>
DL251 I/O box	DL251 I/O box	0dB	+1.0dB	-1.0dB
DL251 I/O box	DL251 I/O box	40dB	+1.0dB	-1.0dB
Surface I/O	Surface I/O	0dB	+1.0dB	-1.0dB
Surface I/O	Surface I/O	40dB	+1.0dB	-1.0dB
DL451 I/O box	DL451 I/O box	0dB	+1.0dB	-1.0dB
DL451 I/O box	DL451 I/O box	40dB	+1.0dB	-1.0dB
DL431 splitter	DL451 I/O box	0dB	+1.0dB	-1.0dB
DL431 splitter	DL451 I/O box	40dB	+1.0dB	-1.0dB
DL431 splitter	DL431 A out	0dB	+0.5dB	-0.5dB
DL431 splitter	DL431 A out	40dB	+0.5dB	-0.5dB
DL431 splitter	DL431 B out	0dB	+0.5dB	-0.5dB
DL431 splitter	DL431 B out	40dB	+0.5dB	-0.5dB
DL431 splitter	DL431 C out	-6dB	+1.0dB	-1.0dB

**Input CMRR**

<i>Input</i>	<i>Output</i>	<i>Gain</i>	<i>100Hz</i>	<i>1kHz</i>
DL251 I/O box	DL251 I/O box	0dB	60dB	60dB
DL251 I/O box	DL251 I/O box	40dB	90dB	90dB
Surface I/O	Surface I/O	0dB	60dB	60dB
Surface I/O	Surface I/O	40dB	90dB	90dB
DL451 I/O box	DL451 I/O box	0dB	80dB	80dB
DL451 I/O box	DL451 I/O box	40dB	90dB	90dB
DL431 splitter	DL451 I/O box	0dB	80dB	80dB
DL431 splitter	DL451 I/O box	40dB	90dB	90dB
DL431 splitter	DL431 A out	0dB	80dB	80dB
DL431 splitter	DL431 A out	40dB	90dB	90dB
DL431 splitter	DL431 B out	0dB	80dB	80dB
DL431 splitter	DL431 B out	40dB	90dB	90dB
DL431 splitter	DL431 C out	-6dB	110dB	90dB

**Distortion at 0dBu**

<i>Input</i>	<i>Output</i>	<i>Gain</i>	<i>1kHz</i>	<i>10kHz</i>
DL251 I/O box	DL251 I/O box	0dB	0.01%	0.01%
DL251 I/O box	DL251 I/O box	40dB	0.03%	0.03%
Surface I/O	Surface I/O	0dB	0.01%	0.01%
Surface I/O	Surface I/O	40dB	0.03%	0.03%
DL451 I/O box	DL451 I/O box	0dB	0.01%	0.01%
DL451 I/O box	DL451 I/O box	40dB	0.03%	0.03%
DL431 splitter	DL431 A out	0dB	0.01%	0.01%
DL431 splitter	DL431 A out	40dB	0.03%	0.03%
DL431 splitter	DL431 B out	0dB	0.01%	0.01%
DL431 splitter	DL431 B out	40dB	0.03%	0.03%
DL431 splitter	DL431 C out	-6dB	0.01%	0.01%
DL431 splitter	DL451 I/O box	0dB	0.01%	0.01%
DL431 splitter	DL451 I/O box	40dB	0.03%	0.03%

**Distortion at +20dBu**

<i>Input</i>	<i>Output</i>	<i>Gain</i>	<i>1kHz</i>	<i>10kHz</i>
DL251 I/O box	DL251 I/O box	0dB	0.03%	0.03%
DL251 I/O box	DL251 I/O box	40dB	0.03%	0.03%
Surface I/O	Surface I/O	0dB	0.03%	0.03%
Surface I/O	Surface I/O	40dB	0.03%	0.03%
DL451 I/O box	DL451 I/O box	0dB	0.03%	0.03%
DL451 I/O box	DL451 I/O box	40dB	0.03%	0.03%
DL431 splitter	DL431 A out	0dB	0.03%	0.03%
DL431 splitter	DL431 A out	40dB	0.03%	0.03%
DL431 splitter	DL431 B out	0dB	0.03%	0.03%
DL431 splitter	DL431 B out	40dB	0.03%	0.03%
DL431 splitter	DL431 C out	-6dB	0.03%	0.03%
DL431 splitter	DL451 I/O box	0dB	0.03%	0.03%
DL431 splitter	DL451 I/O box	40dB	0.03%	0.03%

**Mixing noise (all bus types) 22Hz to 22kHz unweighted**

<i>Number Of Inputs</i>	<i>Gain</i>	<i>Fader Position</i>	<i>Pan</i>	<i>Output Noise</i>
12	0dB	-infinity	Central	-91dBu
12	0dB	0dB	Central	-78dBu
24	0dB	-infinity	Central	-91dBu
24	0dB	0dB	Central	-75dBu
48	0dB	-infinity	Central	-91dBu
48	0dB	0dB	Central	-72dBu
64	0dB	-infinity	Central	-91dBu
64	0dB	0dB	Central	-71dBu

**Signal path noise 22Hz to 22kHz unweighted**

Inputs 150R terminated.

<i>Input</i>	<i>Output</i>	<i>Gain</i>	<i>Output Noise</i>	<i>EIN</i>
DL251 I/O box	DL251 I/O box	0dB	-85dBu	-85dBu
DL251 I/O box	DL251 I/O box	45dB	-81dBu	-126dBu
Surface I/O	Surface I/O	0dB	-85dBu	-85dBu
Surface I/O	Surface I/O	45dB	-81dBu	-126dBu
DL451 I/O box	DL451 I/O box	0dB	-89dBu	-89dBu
DL451 I/O box	DL451 I/O box	40dB	-87dBu	-127dBu
DL431 splitter	DL431 A out	0dB	-98dBu	-98dBu
DL431 splitter	DL431 A out	40dB	-88dBu	-128dBu
DL431 splitter	DL431 B out	0dB	-98dBu	-98dBu
DL431 splitter	DL431 B out	40dB	-88dBu	-128dBu
DL431 splitter	DL431 C out	-6dB	-123dBu	-117dBu
DL431 splitter	DL451 I/O box	0dB	-89dBu	-89dBu
DL431 splitter	DL451 I/O box	40dB	-87dBu	-127dBu

**Dynamic range 22Hz to 22kHz unweighted**

<i>Input</i>	<i>Output</i>	<i>Gain</i>	<i>Maximum Output</i>	<i>Dynamic Range</i>
DL251 I/O box	DL251 I/O box	0dB	+21dBu	106dB
DL251 I/O box	DL251 I/O box	45dB	+21dBu	103dB
Surface I/O	Surface I/O	0dB	+21dBu	106dB
Surface I/O	Surface I/O	45dB	+21dBu	103dB
DL451 I/O box	DL451 I/O box	0dB	+21dBu	110dB
DL451 I/O box	DL451 I/O box	40dB	+21dBu	108dB
DL431 splitter	DL431 A out	0dB	+26dBu	124dB
DL431 splitter	DL431 A out	40dB	+26dBu	114dB
DL431 splitter	DL431 B out	0dB	+26dBu	124dB
DL431 splitter	DL431 B out	40dB	+26dBu	114dB
DL431 splitter	DL431 C out	-6dB	+21dBu	144dB
DL431 splitter	DL451 I/O box	0dB	+21dBu	110dB
DL431 splitter	DL451 I/O box	40dB	+21dBu	108dB



## PRO2 system inputs and outputs

### DL251 I/O box - analogue inputs

<b>Connector</b>	3-pin XLR balanced
<b>A/D converter</b>	24-bit, 96kHz and 128 times oversampling

### DL251 I/O box - analogue outputs

<b>Connector</b>	3-pin XLR balanced
<b>D/A converter</b>	24-bit, 96kHz and 128 times oversampling

### DL251 I/O box - MIDI

<b>MIDI</b>	In, Out and Thru on 5-pin DIN
-------------	-------------------------------

### DL251 I/O box - digital system inputs and outputs

<b>System connector</b>	2 x AES50 (24 channels of bi-directional digital audio) on EtherCon® XLR
<b>N+1 connector</b>	1 x AES50 (24 channels of bi-directional digital audio) on EtherCon® XLR providing redundant back-up

### PRO2 control surface - DSP/router system inputs and outputs

<b>System connector</b>	2 x AES50 (24 channels of bi-directional digital audio) on EtherCon® XLR
<b>N+1 connector</b>	1 x AES50 (24 channels of bi-directional digital audio) on EtherCon® XLR providing redundant back-up
<b>System expansion connector</b>	3 x AES50 (24 channels of bi-directional digital audio) on EtherCon® XLR
<b>Word clock IN connector</b>	BNC
<b>Word clock OUT connector</b>	BNC
<b>AES3 sync IN connector</b>	3-pin XLR
<b>AES3 sync OUT connector</b>	3-pin XLR

**PRO2 control surface - analogue audio system inputs**

<b>Connector</b>	3-pin XLR balanced
<b>A/D converter</b>	24-bit, 96kHz and 128 times oversampling
<b>Talkback connector</b>	3-pin XLR balanced line
<b>Talk connector</b>	3-pin XLR balanced mic with 48V phantom voltage
<b>Meters (11-off)</b>	10-segment, -36dBu to +21dBu

**PRO2 control surface - analogue audio system outputs**

<b>Connector</b>	3-pin XLR balanced
<b>D/A converter</b>	24-bit, 96kHz and 128 times oversampling
<b>Monitor connector</b>	3-pin XLR balanced line
<b>Talk connector</b>	3-pin XLR balanced line
<b>Headphone connector</b>	1/4" Jack (stereo)
<b>Automation advance connector</b>	1/4" Jack (mono)
<b>Meters (24-off)</b>	10-segment, -36dBu to +21dBu
<b>Meters (2-off)</b>	20-segment, -36dBu to +21dBu

**PRO2 control surface - digital audio system inputs and outputs**

<b>Input connector</b>	AES3 (two channels of digital audio) on 3-pin XLR
<b>Sample rates</b>	Accepts any frequency 32kHz - 96kHz
<b>Bypass</b>	Sample rate converter can be bypassed
<b>Output connector</b>	AES3 (two channels of digital audio) on 3-pin XLR
<b>Sample rate</b>	48k, 96k, or auto-tracking to inputs
<b>Bypass</b>	Sample rate converter can be bypassed
<b>Word length</b>	16, 20 or 24-bit

**PRO2 control surface - control data system inputs and outputs**

<b>System connector</b>	EtherCon® XLR
-------------------------	---------------

## PRO2 control centre - miscellaneous inputs and outputs

<b>Monitor output connector</b>	3-row, 15-pin D-type - analogue VGA
<b>USB host connection</b>	USB 2.0 full speed (12.0Mbps) 5V, 1A maximum load
<b>Lamp connector</b>	3-pin XLR

## Inputs and output characteristics

## Analogue input characteristics

<i>Input Type</i>	<i>Load Z</i>	<i>Gain</i>	<i>Maximum Level</i>	<i>Connector</i>
DL251 I/O box	10k	-22.5dB to +65dB	+24dBu	XLR
Surface I/O	10k	-22.5dB to +65dB	+24dBu	XLR
DL451 I/O box	10k	-25dB to +60dB	+26dBu	XLR
DL431 splitter	5k	-22.5dB to +65dB	+24dBu	XLR
Talk mic	600R	+15dB to +60dB	+6dB	XLR
Monitor	10k	0dB	+24dBu	XLR

## Analogue output characteristics

<i>Output Type</i>	<i>Source Z</i>	<i>Gain</i>	<i>Maximum Level</i>	<i>Connector</i>
DL251 I/O box	50R	0dB	+21dBu	XLR
Surface I/O	50R	0dB	+21dBu	XLR
DL451 I/O box	50R	0dB	+21dBu	XLR
DL431 splitter (main)	150R	0dB	+24dBu	XLR
DL431 splitter (isolated)	75R	-6dB	+18dBu	XLR
Talk	50R	0dB	+24dBu	XLR
Monitor	50R	0dB	+24dBu	XLR
Headphones	10R	+10dB	750mW	1/4" Jack

## Digital I/O characteristics

<i>Type</i>	<i>Channels</i>	<i>Data Length</i>	<i>I/O</i>	<i>Description Notes</i>	<i>Connector</i>
AES3	2	24-bit	Input	Conforms to AES3-2003	XLR
AES3	2	24-bit	Output	Conforms to AES3-2003	XLR
AES50	24	24-bit	Bi-directional	Conforms to AES50-2006	EtherCon® XLR

### Miscellaneous digital characteristics

<i>Type</i>	<i>I/O</i>	<i>Description Notes</i>	<i>Connector</i>
Word clock	IN	Accepts TTL level, 96kHz square wave; impedance 75 ohms	BNC
Word clock	OUT	Provides TTL level, 96kHz square wave	BNC
AES sync	IN	Accepts a 96kHz digital audio signal conforming to AES3-2003	XLR
AES sync	OUT	Provides a 96kHz grade II reference signal conforming to AES3-2003	XLR

## Main processing functions

### Main input channel functions

<b>Input channel hi pass</b>	10Hz to 400Hz swept in digital domain Slope selectable 12dB/Oct or 24dB/Oct
<b>Input channel lo pass</b>	2kHz to 20kHz swept in digital domain Slope selectable 6dB/Oct or 12dB/Oct
<b>Input channel treble</b>	Parametric Operation Frequency 1kHz to 25kHz swept Gain +16dB to -16dB BW 0.1 Oct to 3 Oct  Shelf Operation Frequency 1kHz to 25kHz swept Gain +16dB to -16dB Soft, Classic or Bright (minimum harmonic disruption) curves
<b>Input channel hi mid</b>	Parametric Operation Frequency 320Hz to 8kHz swept Gain +16dB to -16dB BW 0.1 Oct to 3 Oct
<b>Input channel lo mid</b>	Parametric Operation Frequency 80Hz to 2kHz swept Gain +16dB to -16dB BW 0.1 Oct to 3 Oct
<b>Input channel bass</b>	Parametric Operation Frequency 16Hz to 400Hz swept Gain +16dB to -16dB BW 0.1 Oct to 3 Oct  Shelf Operation Frequency 16Hz to 400Hz swept Gain +16dB to -16dB Warm, Classic or Deep (minimum harmonic disruption) curves

---

<b>Input channel compressor</b>	<p>Peak, Linear, RMS, Vintage modes          Threshold -50dBu to +25dBu          Attack 200µs to 20ms          Release 50ms to 3 sec          Ratio 25:1 to 1:1          Knee 4dB, 12dB or 40dB          Gain 0dB to +24dB</p> <p>Side chain source selectable + filter          Frequency 50Hz to 15kHz swept          Bandwidth 1/3, 1 or 2 Oct</p>
---------------------------------	---

---

<b>Input channel gate</b>	<p>Peak mode          Threshold -50dBu to +25dBu          Attack 20µs to 20ms          Hold 5ms to 2 sec          Release 2ms to 2 sec          Range 100dB to 0dB</p> <p>Side chain source selectable + filter          Frequency 50Hz to 15kHz swept          Bandwidth 1/3, 1 or 2 Oct</p>
---------------------------	---

---

### Auxiliary input channel functions

---

<b>Aux channel treble</b>	<p>Treble Parametric Operation          Frequency 1kHz to 25kHz swept          Gain +16dB to -16dB          BW 0.1 Oct to 3 Oct</p> <p>Shelf Operation          Frequency 1kHz to 25kHz swept          Gain +16dB to -16dB          Soft, Classic or Bright (minimum harmonic disruption) curves</p>
---------------------------	--

---

<b>Aux channel hi mid</b>	<p>Parametric Operation          Frequency 320Hz to 8kHz swept          Gain +16dB to -16dB          BW 0.1 Oct to 3 Oct</p>
---------------------------	--

---

<b>Aux channel lo mid</b>	<p>Parametric Operation          Frequency 80Hz to 2kHz swept          Gain +16dB to -16dB          BW 0.1 Oct to 3 Oct</p>
---------------------------	---

---

<b>Aux channel bass</b>	<p>Parametric Operation          Frequency 16Hz to 400Hz swept          Gain +16dB to -16dB          BW 0.1 Oct to 3 Oct</p> <p>Shelf Operation          Frequency 16Hz to 400Hz swept          Gain +16dB to -16dB          Warm, Classic or Deep (minimum harmonic disruption) curves</p>
-------------------------	---

---

## Output channel functions

<b>Output channel band 6</b>	<p>Parametric Operation          Frequency 16Hz to 25kHz swept          Gain +16dB to -16dB          BW 0.1 Oct to 3 Oct</p> <p>Lo Pass Operation          Frequency 16Hz to 25kHz swept          Slope 6dB/Oct or 12dB/Oct</p> <p>Shelf Operation          Frequency 16Hz to 25kHz swept          Gain +16dB to -16dB          Mode soft curve</p>
<b>Output channel bands 3, 4 and 5</b>	<p>Parametric Operation          Frequency 16Hz to 25kHz swept          Gain +16dB to -16dB          BW 0.1 Oct to 3 Oct</p>
<b>Output channel band 2</b>	<p>Parametric Operation          Frequency 16Hz to 25kHz swept          Gain +16dB to -16dB          BW 0.1 Oct to 3 Oct</p> <p>Hi Pass Operation          Frequency 16Hz to 25kHz swept          Slope 24dB/Oct</p>
<b>Output channel band 1</b>	<p>Parametric Operation          Frequency 16Hz to 25kHz swept          Gain +16dB to -16dB          BW 0.1 Oct to 3 Oct</p> <p>Hi Pass Operation          Frequency 16Hz to 25kHz swept          Slope 6dB/Oct or 12dB/Oct</p> <p>Shelf Operation          Frequency 16Hz to 25kHz swept          Gain +16dB to -16dB          Mode soft curve</p>
<b>Output channel GEQ</b>	<p>8 available in place of PEQ (above)          31 Bands, 1/3 Oct, Proportional Q          Lo Pass Frequency 2kHz to 20kHz swept          Slope 6dB/Oct or 12dB/Oct          Hi Pass Frequency 20Hz to 500Hz swept          Slope 6dB/Oct or 12dB/Oct</p>
<b>Output channel dynamic</b>	<p>Pk, Linear, RMS, Vintage, Shimmer modes          Threshold -50dBu to +25dBu          Attack 200µs to 20ms          Release 50ms to 3 sec          Ratio 25:1 to 1:1          Knee 4dB, 12dB or 40dB          Gain 0dB to +24dB</p> <p>Side chain source selectable + filter          Frequency 50Hz to 15kHz swept          Bandwidth 1/3, 1 or 2 Oct</p>

### Effects channel functions

<b>Stereo effects channel</b>	4 available configurable as Stereo or mono in, stereo out (8 in, 8 out for dynamic) Modulated delay effects Complex delay, reverbs Advanced dynamics (8 in, 8 out) RTA and advanced measurements
<b>Effects channel GEQ</b>	16 available in place of effects (above) 31 Bands, 1/3 Oct, Proportional Q Lo Pass Frequency 2kHz to 20kHz swept Slope 6dB/Oct or 12dB/Oct Hi Pass Frequency 20Hz to 500Hz swept Slope 6dB/Oct or 12dB/Oct
<b>Effects channel matrix</b>	8 in 8 out matrix (plug in) provides limited Bus expansion for theatre applications

## Status functions

### Meters

<b>Control centre meters</b>	2 x monitor 20 LED –36dBu to +21dBu 24 x output 10 LED –36dBu to +21dBu 11 x input 10 LED –36dBu to +21dBu
<b>Screen metering</b>	88 x 20 segment signal level meters 112 x 7 segment gain reduction

### Screens

<b>Quantity</b>	1 x full colour daylight viewable screens
<b>Size</b>	15 inch (diagonal)
<b>Resolution</b>	1024 X 768 pixels

### LCD switches

<b>Quantity</b>	25 x RGB colour display switches
<b>Size</b>	18 mm x 12 mm display area
<b>Resolution</b>	64 x 32 pixels





## Appendix D: Troubleshooting

This appendix gives details of troubleshooting the PRO2 Live Audio System.

### No audio

If you have set up the PRO2 and followed all of the instructions for obtaining audio, but you are not hearing anything through the speakers, check the following:

- Make sure the appropriate **ST** buttons in the channel faders are on.
- Make sure the appropriate **ST** buttons in the **source a/b** panels (monitors section of the output bay) are on.
- Make sure nothing is muted.
- Make sure no faders are set to minimum.
- Check that the VCA group and master faders are at unity gain.
- Use solo at selected points in the signal path to try and pinpoint where the signal is being lost.
- Check the **Preferences** screen for correct signal routing by making sure channel sources/destinations are correctly assigned.

If you still don't have any audio, contact Midas Technical Support.

### Troubleshooting automation

This section explains the error messages that you may see when using PRO2 automation.

#### Error messages

Error messages, which can appear when you are accessing the **Files** or **Automation** screens, provide useful information on the condition that triggered them. Due to the way the filing and automation systems interact with the internal processing system of the PRO2, not all error messages are indicative of a problem; some may appear due to the current state of the system and just require a retry of the operation.

Error messages comprise two components — a first line of text containing the error condition, followed on the next line by a description of the error (prefixed by the text "response:"). The error condition text indicates the operation that may have triggered the error message, while the error description text explains the reason for failure and, in some cases, also provides information that may be useful to service engineers. The following diagram shows a typical error message.

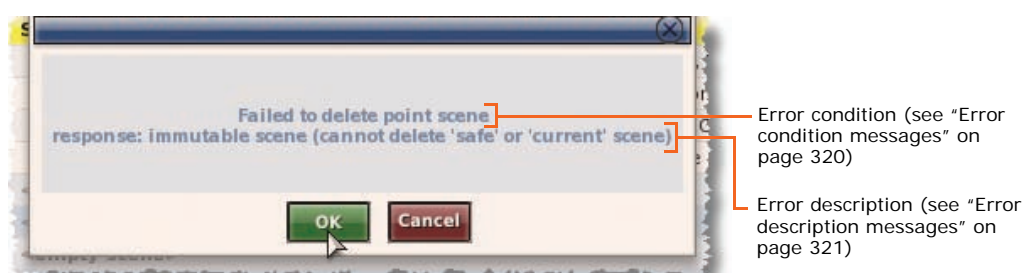

**>> To proceed after an error message appears**

- 1** Heed the error message.
- 2** Click **OK**.
- 3** Take the appropriate action for that particular error. Refer to Table 14 “List of error condition messages” on page 320 and Table 15 “List of error description messages” on page 321.

**Automation error messages**

An automation error message may be generated by any of the following:

- An attempt to perform a copy and paste is ignored.
- Attempting to assign notes to a scene. The text “There was an error setting the scene note” will be displayed.
- An attempt to assign MIDI data to a scene is ignored.
- An attempt to set the navigation mode, that is, switching rehearsal mode on or off, is ignored.
- An attempt to skip/unskip a scene or point scene; see “Rehearsals” on page 173.
- An attempt to assign the default store option is ignored.
- An attempt to assign the rehearsal mode state for all scenes is ignored. (This functionality is not available to the user.)
- An attempt to set the MIDI navigation mode is ignored. (This functionality is not available to the user.)
- An attempt to modify the scene list mode is ignored.

**Error condition messages**

The following table contains the possible error condition messages for both the file and automation systems. These messages comprise the first line of the error message as they appear on the GUI.

**Table 14: List of error condition messages**

<i>System Type</i>	<i>Error Message</i>	<i>Fault Condition</i>
File	Failed to copy file	Attempting to copy a file.
File	Failed to delete file	Attempting to delete a file.
File	Failed to rename file	Attempting to rename a file.
Automation	Failed to copy point scene to point scene	Attempting to copy one point scene to another.
Automation	Failed to create a new show	Attempting to create a new show.
Automation	Failed to delete point scene	Attempting to delete a point scene.
Automation	Failed to expand point scene range	Attempting to expand point scene range, that is, by inserting an extra 10 point scenes, for example, expanding scene 10.00 will add point scenes 10.10, 10.20 etc., up to 10.90.
Automation	Failed to initiate point scene storage	Attempting to initiate point scene storage, that is, when clicking <b>Store</b> on the GUI. (A successful outcome is to display the ‘Store’ window.)

<i>System Type</i>	<i>Error Message</i>	<i>Fault Condition</i>
Automation	Failed to insert point scene	Attempting to complete point scene storage by clicking <b>OK</b> after selecting "Insert before scene".
Automation	Failed to load show	Attempting to load a show file.
Automation	Failed to recall last scene	Attempting to recall the previous scene to the control surface.
Automation	Failed to recall Next scene	Attempting to recall the next scene to the control surface.
Automation	Failed to recall Now scene	Attempting to reload the current scene or the current jog scene (if any) to the control surface.
Automation	Failed to rename point scene	Attempting to rename a point scene.
Automation	Failed to save file	Attempting to save a currently loaded file.
Automation	Failed to save file to new name	Attempting to save a currently loaded show file to another file name, that is, by using the <b>Save As</b> button.
Automation	Failed to store point scene	Attempting to complete point scene storage by clicking <b>OK</b> after selecting "Store to empty scene", "Overwrite scene" or "Store to empty scene".
Automation	Failed to unexpand point scene range	Attempting to unexpand point scene range. This is the opposite of expanding the point scene range (immediately above) and can only be carried out if the 10 point scenes to be unexpanded are empty.

**Error description messages**

The following table contains the possible error description messages for both the file and automation systems, which will start on the second line of the error message. The "Error Message" column in the table contains the error message text that immediately follows the "response:" text. For ease of reference the table lists the error messages in alphabetical order.

**Table 15: List of error description messages**

<i>Error Message</i>	<i>System(s)</i>	<i>Problem</i>	<i>Solution</i>
<b>hexadecimal number</b>			
<error code in hexadecimal> unknown error code	File and Automation	Indication of a possible system error.	Note down the hexadecimal value of the error code and contact Midas Technical Support, giving them this value.
<b>a</b>			
artefact clone policy violation	File and Automation	The cloning of this artefact (file type) is not allowed.	Avoid using this type of operation.

<i><b>Error Message</b></i>	<i><b>System(s)</b></i>	<i><b>Problem</b></i>	<i><b>Solution</b></i>
artefact creation policy violation	File and Automation	The creation of this file type is not allowed.	Avoid using this type of operation.
artefact deletion policy violation	File and Automation	The deleting of this file type is not allowed.	Avoid using this type of operation.
artefact import violation	File and Automation	The importing of this file type is not allowed.	Avoid using this type of operation.
artefact load policy violation	File and Automation	The loading of this file type is not allowed.	Avoid using this type of operation.
artefact rename policy violation	File and Automation	The renaming of this file type is not allowed.	Avoid using this type of operation.
artefact replication policy violation	File and Automation	The replication of this file type is not allowed.	Avoid using this type of operation.
artefact save policy violation	File and Automation	The saving of this file type is not allowed.	Avoid using this type of operation.
attempt to overwrite existing data (overwrite not enabled)	File and Automation	The operation to save or copy to the existing file is not allowed, as files cannot be overwritten.	Avoid using this type of operation.
<b>b</b>			
bad device	File and Automation	Operation could not be carried out because the device, that is, the internal compact flash of the PRO2 or USB memory stick (if connected), does not contain the required directory structure.	<ul style="list-style-type: none"> <li>• If the device is the internal compact flash of the PRO2, this could be an indication of a serious problem. Contact Midas Technical Support.</li> <li>• If the device is the USB memory stick, check that the device has not been disconnected from the control surface.</li> </ul>
bad device ID	File and Automation	The device identifier has not been recognised.	If you are exporting a file to a USB memory stick, check that it has not been disconnected from the control surface.
bad directory	File and Automation	The file system path does not terminate in a directory.	This is highly unlikely to occur in practice, but is an indication of a serious error. Contact Midas Technical Support.
bad file	File and Automation	The file system path does not terminate in a file.	This is highly unlikely to occur in practice, but is an indication of a serious error. Contact Midas Technical Support.

<i><b>Error Message</b></i>	<i><b>System(s)</b></i>	<i><b>Problem</b></i>	<i><b>Solution</b></i>
bad file artefact	File and Automation	The file has been detected as not valid. Preferences, preset library and show files are validated by comparing their actual attributes against the corresponding fields stored in the header of the file, such as, file size, checksum etc.	Try again. If still unsuccessful, and if the file is a show file, try a backup file, if one is available.
bad file version	File and Automation	The preferences, preset library or show file could not be opened because its file header version field was not valid.	Try again. If still unsuccessful, and if the file is a show file, try a backup file, if one is available.
bad path	File and Automation	A file or directory is missing.	This is an indication of a serious error. Contact Midas Technical Support.
bad point scene ID	File and Automation	The scene's point scene ID cannot be found.	Try again.
<b>c</b>			
c-lib file error	File and Automation	Critical internal error.	This is an indication of a serious error. Contact Midas Technical Support.
c-lib error	File and Automation	Critical internal error.	This is an indication of a serious error. Contact Midas Technical Support.
c-lib process error	File and Automation	Critical internal error.	This is an indication of a serious error. Contact Midas Technical Support.
<b>d</b>			
device utilisation policy violation	File and Automation	The device is full.	If necessary, backup some files and delete them from the device to free up some memory.
<b>e</b>			
empty point scene index	File and Automation	An attempt was made to navigate an empty point scene index.	Try again. If unsuccessful, and if the file is a show file, try a backup file, if one is available.
event is already active	Automation	Critical internal error.	This is an indication of a serious error. Contact Midas Technical Support.
<b>f</b>			
failed to add to lock list	File	A device or file could not be 'locked' to prevent another task accessing it while it is in use.	Although, in practice, it is highly unlikely to occur, this error may indicate a serious system failure. Contact Midas Technical Support.
failed to add scene	File and Automation	The scene could not be added.	Try again.

<i>Error Message</i>	<i>System(s)</i>	<i>Problem</i>	<i>Solution</i>
failed to allocate memory	Automation	The MC was unable to allocate sufficient memory (RAM) to complete the task.	Switch off the DL251/DL252 Audio System I/O and switch it back on again. If the problem persists, it could be an indication of a serious error. Contact Midas Technical Support.
failed to configure scope mask	Automation	The 'copy and paste through scenes' operation failed.	Try again. If repeated attempts fail, contact Midas Technical Support.
failed to create show	Automation	A new show could not be created.	Try again. If repeated attempts fail, contact Midas Technical Support.
failed to deschedule event	Automation	Critical internal error.	This is an indication of a serious error. Contact Midas Technical Support.
failed to schedule event	Automation	Critical internal error.	This is an indication of a serious error. Contact Midas Technical Support.
<b>i</b>			
immutable scene (cannot delete 'safe' or 'current' scene)	File and Automation	The operation on the current or safe scene is not allowed. The safe scene cannot be edited or deleted and you cannot store to it. Also, you cannot delete the scene last recalled to the control surface. (Precludes the use of the <b>Now</b> button.)	Avoid using these types of operation.
<b>j</b>			
jog position is empty	Automation	The current scene is empty.	Avoid this type of operation on an empty scene.
<b>m</b>			
missing file	File and Automation	The required file cannot be found.	Try again.
missing navigation state	Automation	Critical internal error.	This is an indication of a serious error. Contact Midas Technical Support.
mtools lookup	File and Automation	Critical internal error.	This is an indication of a serious error. Contact Midas Technical Support.
<b>n</b>			
no CBMA access	Automation	Automation manager does not have access to the current control surface settings.	Try again or try switching off the DL251/DL252 Audio System I/O and then switching it back on again. If the problem persists, contact Midas Technical Support.

<i>Error Message</i>	<i>System(s)</i>	<i>Problem</i>	<i>Solution</i>
no next scene	Automation	There is no next scene relative to the current position in the scene list. This is generated by recalling the next scene when the current scene is the last in the scene list.	Avoid this operation on the last scene in the cue list.
no previous scene	Automation	There is no previous scene relative to the current position in the scene list. This is generated by recall the last scene when the current scene is 00.00, that is, the safe scene.	Avoid this operation on the safe scene.
no scene data	Automation	The scene contains no scene notes or MIDI data.	Only carry out this type of operation on a scene that contains scene notes or MIDI data.
no show loaded	Automation	There is no show loaded.	Only carry out this type of operation with a show loaded.
not in storing state	Automation	The Automation System was momentarily unable to store a scene.	Try again. If repeated attempts fail, contact Midas Technical Support.
null pointer	File and Automation	Critical internal error.	This is an indication of a serious error. Contact Midas Technical Support.

**p**

persistent storage error	File and Automation	The GUI or one of its subsystems is out of date and cannot interpret the new failure modes.	Update the GUI and its subsystems. If the problem persists, contact Midas Technical Support.
point scene index continuity error	File and Automation	The show file being modified is damaged.	This is an indication of a serious error. Contact Midas Technical Support.
point scene index integrity error	File and Automation	The show file being modified is damaged.	This is an indication of a serious error. Contact Midas Technical Support.
point scene insert error	File and Automation	Failed to insert a point scene.	This is highly unlikely to occur in practice, but is an indication of a serious error. Contact Midas Technical Support.
portable scene format conversion error	Automation	The attempt to load a show, which was last saved by an MC built with a different enum version, failed during the scene conversion stage of the loading process.	Try again. If repeated attempts fail, contact Midas Technical Support.

<i>Error Message</i>	<i>System(s)</i>	<i>Problem</i>	<i>Solution</i>
<b>r</b>			
required device has files that are in use	File and Automation	Another task is currently accessing file(s) on the device, that is, the internal compact flash of the PRO2 or USB memory stick (if connected).	Try again.
required device is locked	File and Automation	Another task is currently accessing the device, that is, the internal compact flash of the PRO2 or USB memory stick (if connected).	Try again.
<b>s</b>			
scene capacity violation	File and Automation	The scene cannot be stored to the show file, as it already contains the maximum number of scenes allowed.	If necessary, delete one or more of the other scenes. The maximum capacity for a show file is 500 scenes for a 512MB master controller (MC) and 1000 scenes for a 1GB MC.
scene UID error	File and Automation	The file being modified is damaged.	This is an indication of a serious error. Contact Midas Technical Support.
shell command error	File and Automation	This is a critical internal error.	This is an indication of a serious error. Contact Midas Technical Support.
source point scene is empty	Automation	Specified source scene is an empty 'slot'.	Only carry out this type of operation on a scene that is not empty.
specified file is already locked	File and Automation	Another task is currently accessing the file	Try again.
specified file was not found	File and Automation	The file could not be found on the specified device, that is, the internal compact flash of the PRO2 or USB memory stick (if connected).	<ul style="list-style-type: none"> <li>• If the device is the internal compact flash of the PRO2, this could be an indication of a serious problem. Contact Midas Technical Support.</li> <li>• If the device is the USB memory stick, check that the device has not been disconnected from the control surface.</li> </ul>
stdio stream error	File and Automation	This is a critical internal error.	This is an indication of a serious error. Contact Midas Technical Support.
stdio stream open error	File and Automation	This is a critical internal error.	This is an indication of a serious error. Contact Midas Technical Support.
stdio stream seek error	File and Automation	This is a critical internal error.	This is an indication of a serious error. Contact Midas Technical Support.



<i>Error Message</i>	<i>System(s)</i>	<i>Problem</i>	<i>Solution</i>
storage policy violation	File and Automation	There has been a 'storage policy' violation. (This is not necessarily a critical error.)	Ensure that all software components are up to date. If the problem persists Contact Midas Technical Support.
<b>t</b>			
the <file/automation> manager is not registered	File and Automation	The System Manager is momentarily unavailable.	Try again.
<b>u</b>			
unknown parameter enum value	Automation	A parameter with a value that was not valid was supplied to the MC.	Try again. If this occurs again, contact Midas Technical Support.



---

## **Appendix E: Updating The PRO2 Host Software**

This appendix shows you how to update the host software of the PRO2 and also its associated networked devices.

### **About the PRO2 updater**

The PRO2 has an update facility that provides an easy and straightforward method of updating your system. It lets you install the latest version of host software on the PRO2 Control Centre and also any networked DLnnn or Klark Teknik DN9331 Rapide Graphic Controller units.

The updater file is copied onto a USB memory stick, which is plugged into the PRO2 Control Centre. The console will recognise the updater file and let you start the updater, which will detect all units in your system and let you selectively upgrade them to the new software.

By using the updater, you can install an earlier version of the host software on your system if you should ever need to.

## About the updater screen

During installation the updater screen will appear. This screen lets you select the system devices you want to upgrade, start the update procedure and also shows you how the procedure is progressing.

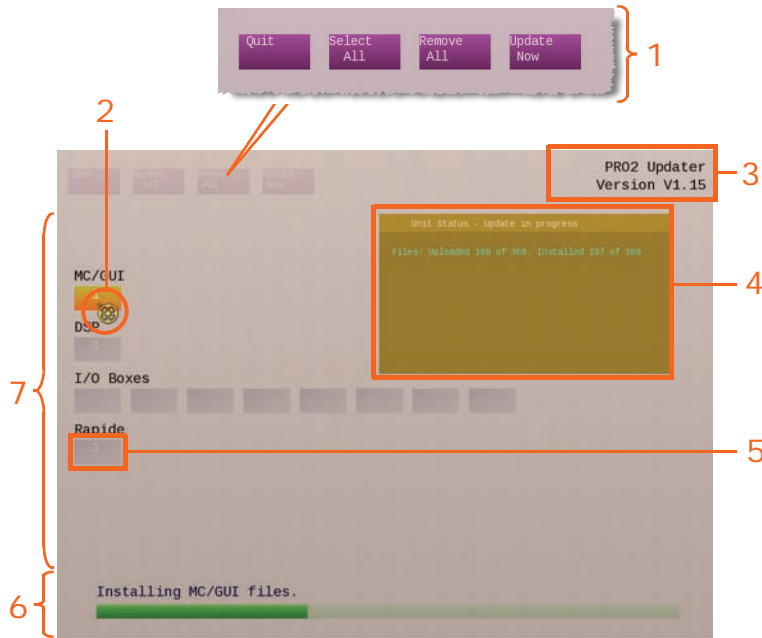



Figure 29: A typical updater display

Item	Description	Function
1	Updater menu	See "Updater menu" on page 331.
2	Pointer	The pointer, which has two possible icons (both translucent yellow) depending on the update status, changes to an arrowhead icon  when the updater is ready for you to select the devices that you want to update. The pointer becomes a roundel  icon during the update procedure; it rotates to show that the update is in progress.
3	PRO2 host software version	Shows the PRO2 host software version that the system will be updated to.
4	<b>Unit Status</b> window	See "Unit Status window" on page 331.
5	Device block	See "Device blocks" on page 331.
6	Update status bar	The green bar shows the progress of the update procedure, whether it is for the device currently being updated or for the whole procedure itself. The text immediately above shows what status the green bar is representing.
7	Device area	Shows possible/actual system devices.







## Updater menu

The following table gives a description of the updater menu commands.

<i>Command</i>	<i>Function</i>
<b>Quit</b>	Exits the updater. After a power cycle, the control centre returns to the operating condition it was in when the updater command was selected from the GUI menu.
<b>Select All</b>	Selects all Midas devices connected (and detected) in the PRO2 Live Audio System.
<b>Remove All</b>	Deselects all Midas devices connected (and detected) in the PRO2 Live Audio System.
<b>Update Now</b>	Starts the update procedure.

## Device blocks

Each device block represents a possible or actual device connected in the system. The device block number is referenced to the device's ID. The colour of each device block indicates the update status of the device, which is shown in the following table.

<i>State</i>	<i>Description</i>
	Grey background — appears during the updater's 'triggering upgrade client' procedure. If its appearance doesn't change throughout the update procedure, either there is no device connected in this position or one has not been detected.
	Blue background without roundel — appears after the updater's 'triggering upgrade client' procedure has finished to show you that there is a device connected in this position.
	Blue background with roundel — appears after this device has been selected for update.
	Gold background with roundel — this device is currently being updated.
	Green background with tick — this device has successfully been updated.
	Red background with cross — this device's update has failed.

## Unit Status window

You can get more detailed information on the update progress of a device by moving the pointer over it. A translucent window (a typical one is shown right) will open towards the upper-right corner of the screen. The window has a title bar at the top and information below.

The colour of the window matches the colour of its associated device block, which gives an indication of its update status, as described in the previous section.

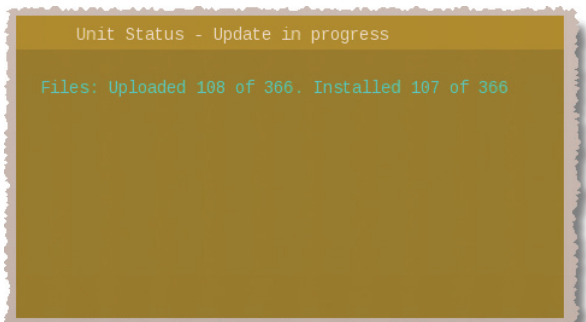

## Using the PRO2 updater

This section shows you how to update your PRO2 Live Audio System. However, before you begin there are a few things you will need and some things you must do.

### What you will need

Before you begin, check that you have the following:

- **USB memory stick** The USB memory stick (flash drive) must have enough available memory to store any shows that you will need to backup, plus an additional 150MB of memory for the update package (that is, the file with a .tar extension). It should also preferably be of USB 2.0 specification.
- **Stable mains supply** If the power drops at a critical point during the update, it is possible — although unlikely — that this could cause some of the system components not to function. A warning window opens before you start the update procedure to remind you of this.

### Preparation

Before you begin, do the following:

- **Backup your shows** It is likely that any shows will be erased when you power cycle the PRO2 following an update. We therefore recommend that you backup your shows onto the USB memory stick (see “Saving your show files to a USB memory stick” on page 91), and then copy them onto a PC.
- **Check that everything is connected** Make sure that everything on the system is correctly connected, configured and functioning properly.
- **Switch off speakers** During the update procedure the DSP and AES routing may perform a number of resets during which the audio may not be in a controlled state. We therefore recommend that you switch off any speakers connected to the system.
- **Make sure you have enough time** The update procedure may take quite a while to complete, so make sure you have at least 25 minutes free before you start. **We do not recommend carrying out an update just before a performance!**
- **Configure the USB memory stick** Create a folder at the top level (root directory) of your USB memory stick called “DL2upgrades”. Then, copy the latest update file (PRO2xxx.tar) into it.

### Updating your system

**! UPGRADING YOUR SYSTEM WILL CAUSE THE CONTROL CENTRE TO LOSE SYNCHRONISATION, WHICH CAN RESULT IN LOUD NOISES FROM THE SYSTEM. ALWAYS MUTE THE PA AT THE AMPLIFIER/SPEAKER BEFORE UPDATING YOUR SYSTEM.**

**! Do not switch off the power to any of the system devices while the PRO2 is carrying out the installation of the host software.**

The installation process is carried out with the PRO2 Control Centre fully powered up and operational.

## &gt;&gt; To update the PRO2

- 1 Mute the PA at the amplifier/speaker.
- 2 Plug the USB memory stick containing the .tar file into the **USB key** socket on the control surface of the PRO2 (see "Control surface" on page 235). The "Run upgrade utility?" window will open automatically.



If there is more than one upgrade file on the USB memory stick, you will be instructed on how to select the desired one from the menu. Otherwise, a single upgrade file will be loaded automatically.

The following is the update procedure:

- 3 The "PREPARING UPDATER" screen opens. The updater makes an integrity check of all the files included in the update before launching fully. The text towards the bottom of the screen will inform you of the updater progress.



- 4 After the updater preparation has finished, the updater screen opens. It automatically runs through a sequence to detect all units in the system, during which the updater menu is unavailable. When it has finished, the text just above the green bar (shown right) will show "Select items for upgrade" and the devices available for upgrade will be coloured blue (see "Device blocks" on page 331).

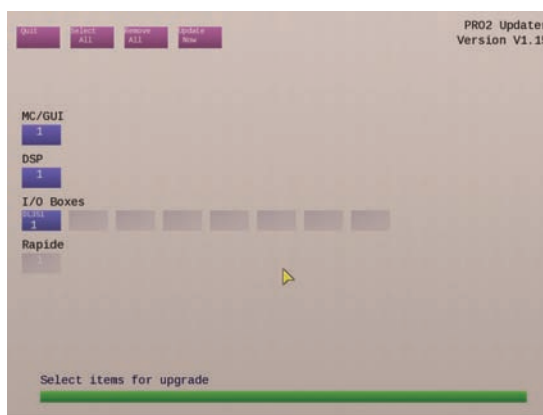

**Note:** In the unlikely event that the "Some units not detected" message appears, check that your system interconnections are good and click **OK** to continue.

- 5 Click **Select All** to select all the devices for update. However, if you want to edit the selections, click on the device blocks to select/deselect individual ones. You can also click **Remove All** to deselect all of the ones selected. A Midas roundel will appear in the blocks of the devices selected for upgrade.
- 6 Click **Update Now**. A warning window will open (see below).

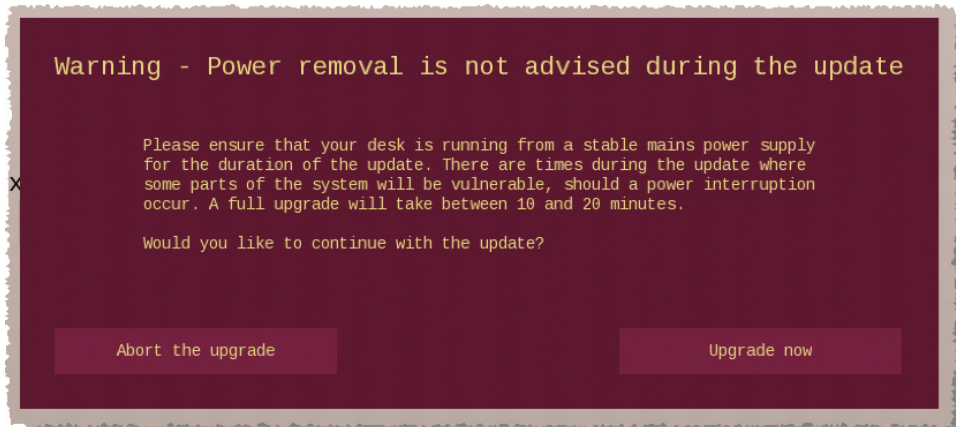

- 7 Click **Upgrade now**. A window will open asking if you would like to back up your shows.

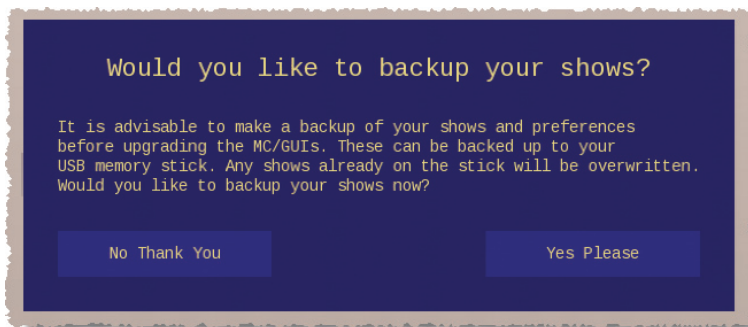

- 8 Click **No Thank You** to start the upgrade. (If, at this point, you want to back up your shows and preferences, click **Yes Please**.) The device blocks will change colour according to their update status (see “Device blocks” on page 331). The green bar at the bottom will show the progress of the current action. A typical screen display during the update procedure is shown in Figure 29 “A typical updater display” on page 330.

**During the upgrade, leave all of the system devices switched on.**

- 9 When the upgrade procedure has finished, you will see the “Upgrade complete” message (shown right).

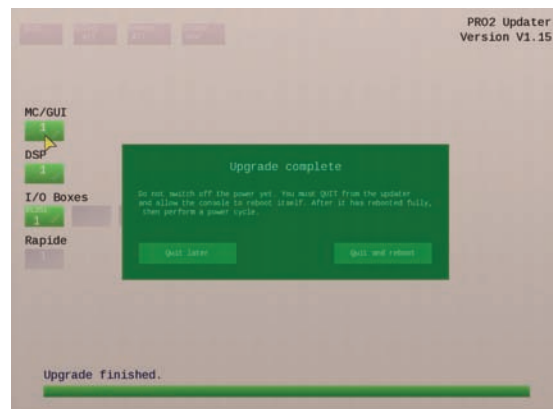

**!** Do not switch off the power until the console has fully rebooted.



- 10 Click **Quit and reboot** to exit the updater and automatically reboot the PRO2. (You can exit the updater later by clicking **Quit later**.)

The GUI will display the screen shown right.

**Do not switch off the power until the console has fully rebooted.**



- 11 When the PRO2 has fully rebooted, power cycle the system (including all I/O boxes) to restart using the new software. Do this by powering the system down and then powering it up again (see "Powering the PRO2 system" on page 30).



# Appendix F: Parameters Affected By Scope

This appendix shows the parameters that are affected by scope.

**Note:** The parameter areas for the scopes (store and recall) and the safes are basically the same. However, the way they are presented in their respective appendix is different. This may provide you with a useful alternative when referring to this material, should you prefer one more than the other (see Appendix H "Parameters Protected By Safes" on page 385).

## Introduction

This appendix shows you which parameters are or are not scoped when you select the parameter sections in the channels, buses, groups, effects and GEOs on the **Store Scope** and **Recall Scope** screens.

There is a section for each area (channel, bus, group, effect and GEO) on the scope screen, and these sections are then subdivided according to the detail areas in the fast/channel strips on the control surface and GUI.

The following diagram shows the **Store Scope** and **Recall Scope** screens (with no parameter sections selected), and the table to the right shows what the symbols in each section mean. In the table the orange letters in the **Ref.** column are used in the tables throughout this appendix to quickly identify the parameter sections.

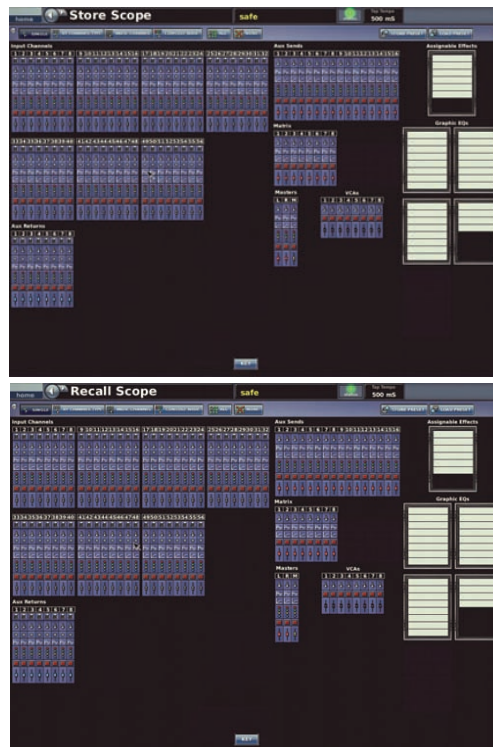

Ref.	Parameter section	Symbol
A	Routing	
B	All	
C	Mic Amp	
D	EQ	
E	Dyn	
F	Busses	
G	Mute	
H	Fader	

The following is the key to the tables in this appendix: **Yes** = scoped, **No** = not scoped and N/A = not applicable.

## Overview

The following table shows the page references (in this chapter) of the control areas for the channels, GEOs, effects and VCA groups.

**Table 16: Reference to scope areas**

<i>Control area</i>	<b>Input Channels</b>	<b>Aux Returns (Returns)</b>	<b>Aux Sends (Auxes)</b>	<b>Matrix (Matrices)</b>	<b>Masters</b>	<b>Graphic EQs</b>	<b>Assignable Effects</b>	<b>Variable Control Associations (VCAs)</b>
<b>Patching</b>	Page 339	Page 350	Page 356	Page 363	Page 369	Page 376	Page 378	N/A
<b>Configuration</b>	Page 340	Page 351	Page 357	Page 364	Page 370	N/A	N/A	N/A
<b>Dynamics</b>	Page 342	N/A	Page 358	Page 365	Page 371	N/A	N/A	N/A
<b>Insert</b>	Page 344	N/A	Page 359	Page 366	Page 372	N/A	N/A	N/A
<b>EQ</b>	Page 345	N/A	Page 360	Page 367	Page 373	N/A	N/A	N/A
<b>Aux send</b>	Page 346	N/A	N/A	N/A	N/A	N/A	N/A	N/A
<b>Matrix send</b>	Page 347	Page 354	Page 361	N/A	Page 374	N/A	N/A	N/A
<b>Fader</b>	Page 348	Page 355	Page 362	Page 368	Page 375	N/A	N/A	N/A
<b>GEO</b>	N/A	N/A	N/A	N/A	N/A	Page 377	N/A	N/A
<b>Effects</b>	N/A	N/A	N/A	N/A	N/A	N/A	Page 379	N/A
<b>Groups</b>	N/A	N/A	N/A	N/A	N/A	N/A	N/A	Page 380

# Inputs

Each scope screen has 56 input channels in the **Input Channels** section.

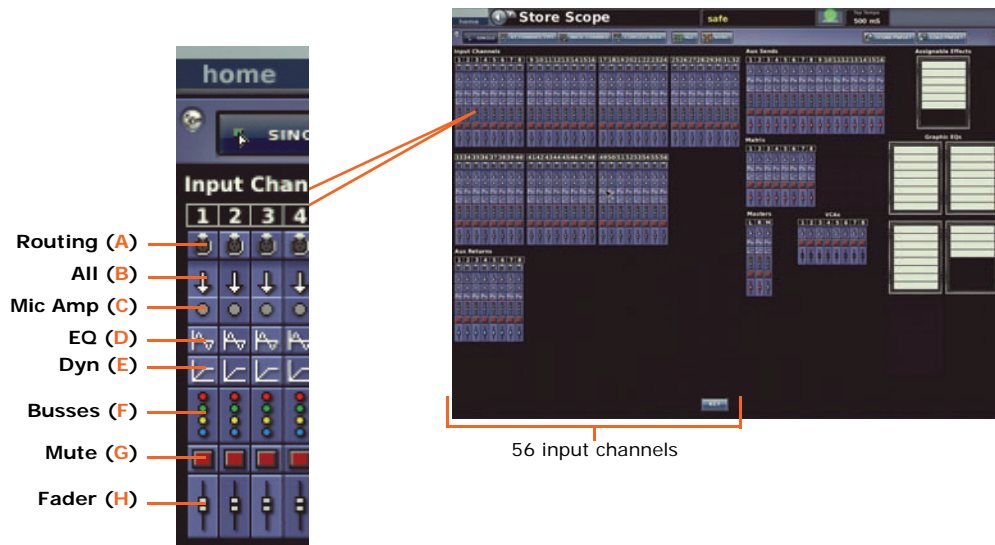
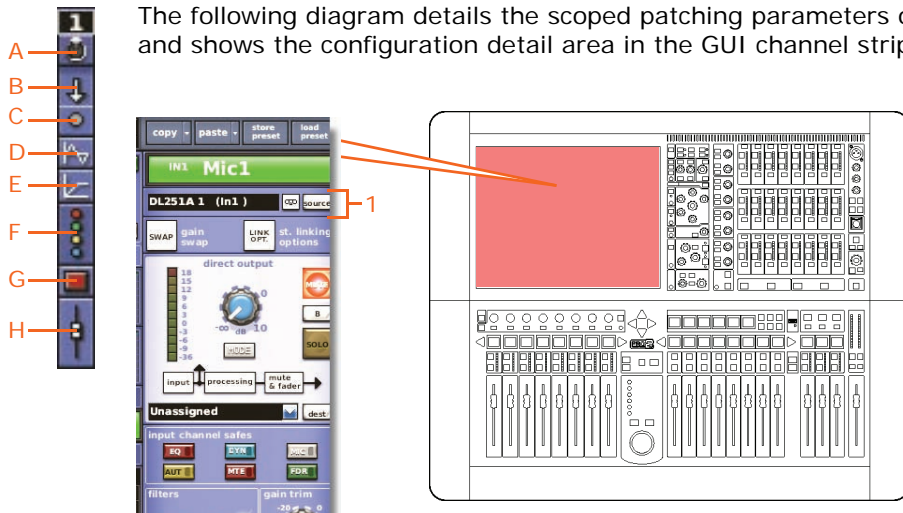

Figure 30: Parameter sections per input channel

## Patching

The following diagram details the scoped patching parameters of the input channels, and shows the configuration detail area in the GUI channel strip.



		A	B	C	D	E	F	G	H
<b>Item</b>	<b>Parameter</b>								
<b>1</b>	Input patching source	Yes*	Yes*	No	N/A	N/A	N/A	N/A	N/A







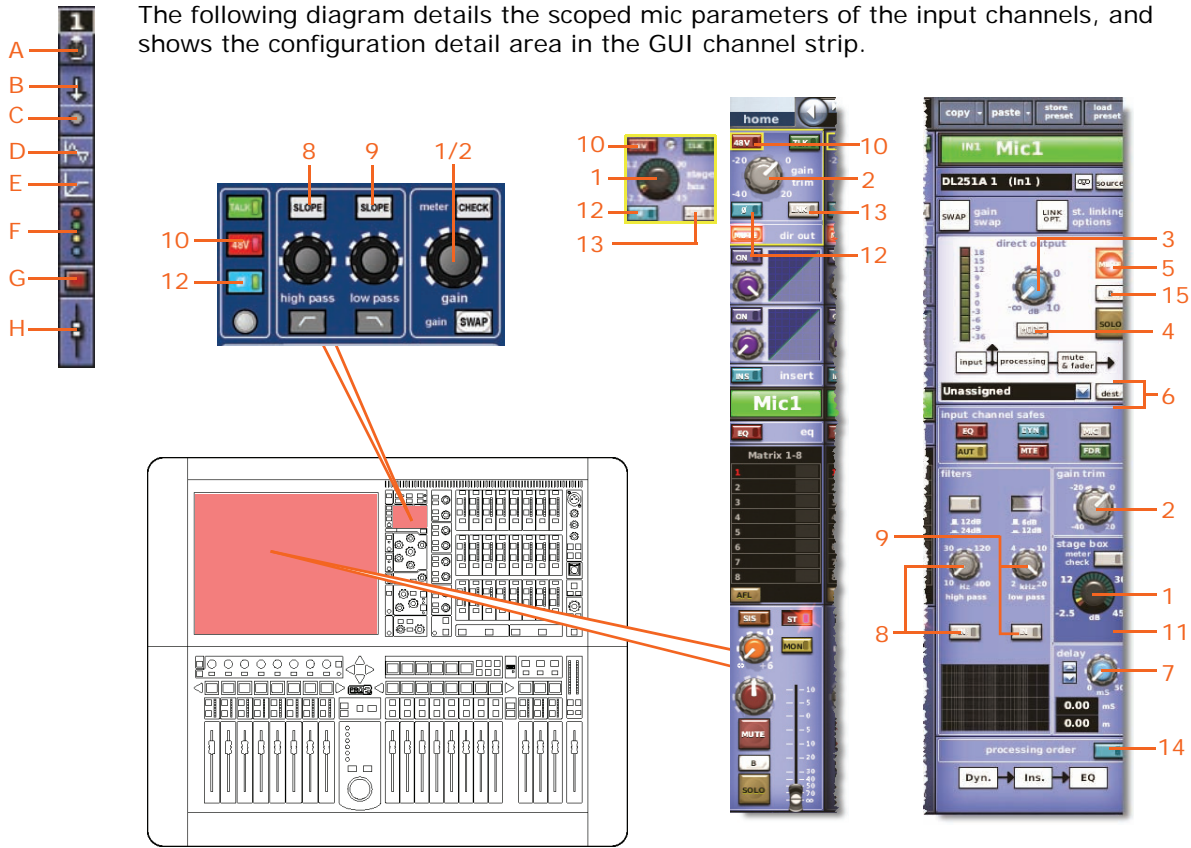

\* Includes tape return and primary input sources.

Configuration

The following diagram details the scoped mic parameters of the input channels, and shows the configuration detail area in the GUI channel strip.



		A	B	C	D	E	F	G	H
<b>Item</b>	<b>Parameter</b>								
1	Mic gain*	N/A	Yes	Yes	N/A	N/A	N/A	N/A	N/A
2	Digital trim*	N/A	Yes	Yes	N/A	N/A	N/A	N/A	N/A
3	Direct output level	N/A	Yes	Yes	N/A	N/A	N/A	N/A	N/A
4	Direct output tap-off point	N/A	Yes	Yes	N/A	N/A	N/A	N/A	N/A
5	Direct output mute	N/A	Yes	No	N/A	N/A	N/A	Yes	N/A
6	Direct output patch destination	N/A	No	No	N/A	N/A	N/A	N/A	N/A
7	Input delay	N/A	Yes	Yes	N/A	N/A	N/A	N/A	N/A
8	Hi pass filter: slope in/out and rotary control	N/A	Yes	No	Yes	N/A	N/A	N/A	N/A
9	Low pass filter: slope in/out and rotary control	N/A	Yes	No	Yes	N/A	N/A	N/A	N/A
10	48V	N/A	Yes	Yes	N/A	N/A	N/A	N/A	N/A
11	30Hz filter**	N/A	Yes	Yes	N/A	N/A	N/A	N/A	N/A
12	Input phase	N/A	Yes	Yes	N/A	N/A	N/A	N/A	N/A

		A	B	C	D	E	F	G	H
<i>Item</i>	<i>Parameter</i>								
13	Link	N/A	No	No	No	No	No	No	No
14	Processing order	N/A	Yes	N/A	Yes	N/A	N/A	N/A	N/A
15	Direct output solo B assignment	N/A	No	No	No	No	No	No	No

\* Depends on swap status.

\*\* Only when sourced from a DL431 Mic Splitter.



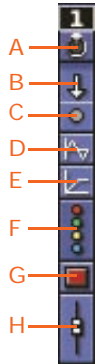



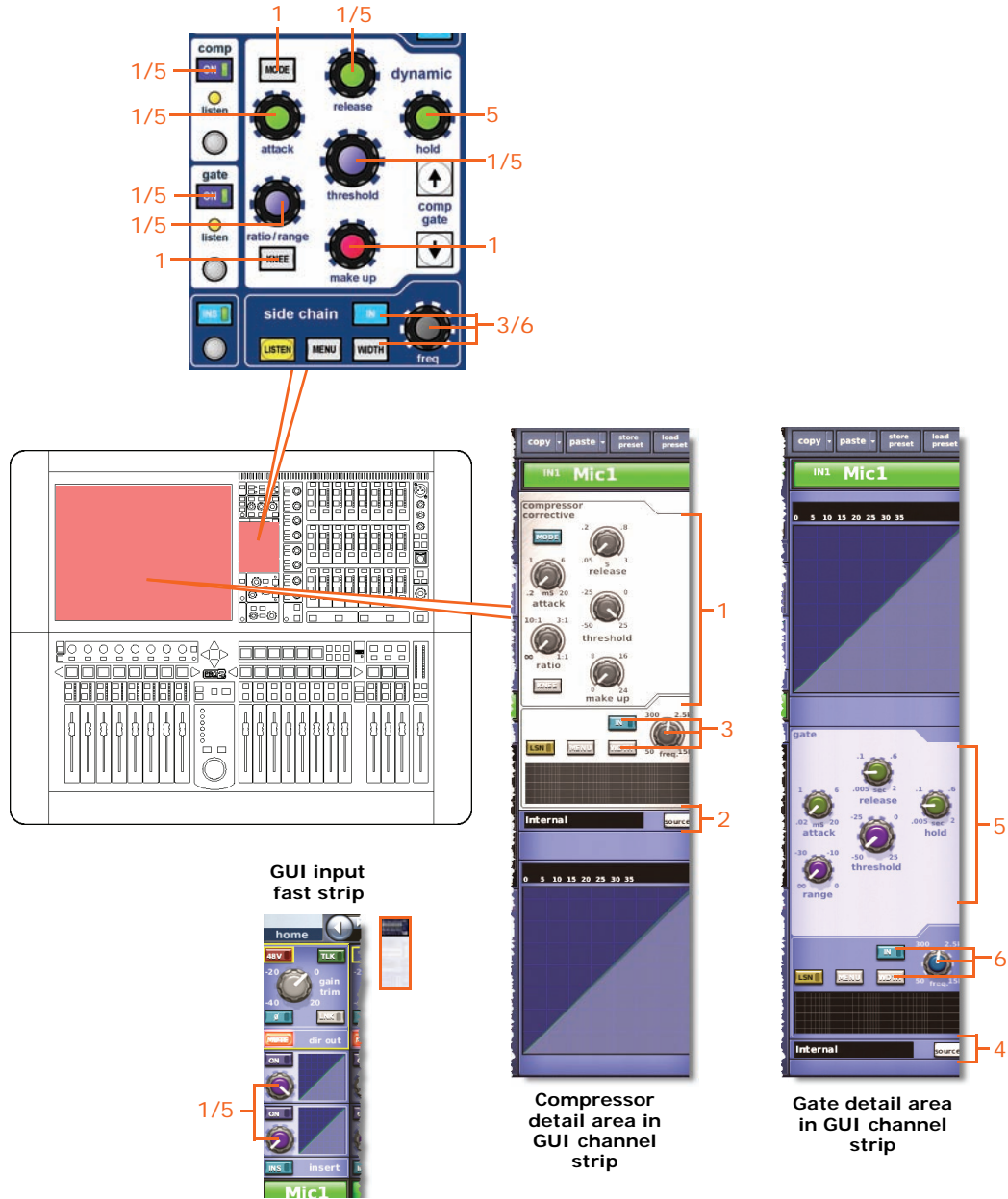

Dynamics



The following diagram details the scoped compressor and gate parameters of the input channels, and shows the compressor and gate detail areas of the GUI channel strip. Although it only shows the corrective compressor, it also applies to the adaptive, creative and vintage compressors.





Item	Parameter	A	B	C	D	E	F	G	H
									
1	Compressor: <b>attack</b> , <b>release</b> , <b>threshold</b> , <b>ratio/range/[ratio]</b> , <b>gain</b> (make up), <b>KNEE</b> , <b>MODE</b>	N/A	Yes	N/A	N/A	Yes	N/A	N/A	N/A
2	Compressor sidechain source	No	N/A	N/A	N/A	N/A	N/A	N/A	N/A
3	Compressor sidechain: <b>IN</b> , <b>freq</b> , and <b>WIDTH</b>	N/A	Yes	N/A	N/A	Yes	N/A	N/A	N/A
4	Gate key in source	No	N/A	N/A	N/A	N/A	N/A	N/A	N/A
5	Gate: <b>attack</b> , <b>release</b> , <b>hold</b> , <b>threshold</b> , <b>ratio/range/[range]</b>	N/A	Yes	N/A	N/A	Yes	N/A	N/A	N/A
6	Gate sidechain: <b>IN</b> , <b>freq</b> , and <b>WIDTH</b>	N/A	Yes	N/A	N/A	Yes	N/A	N/A	N/A

Insert

The following diagram details the scoped insert parameters of the input channels, and shows the insert detail area in the GUI channel strip.

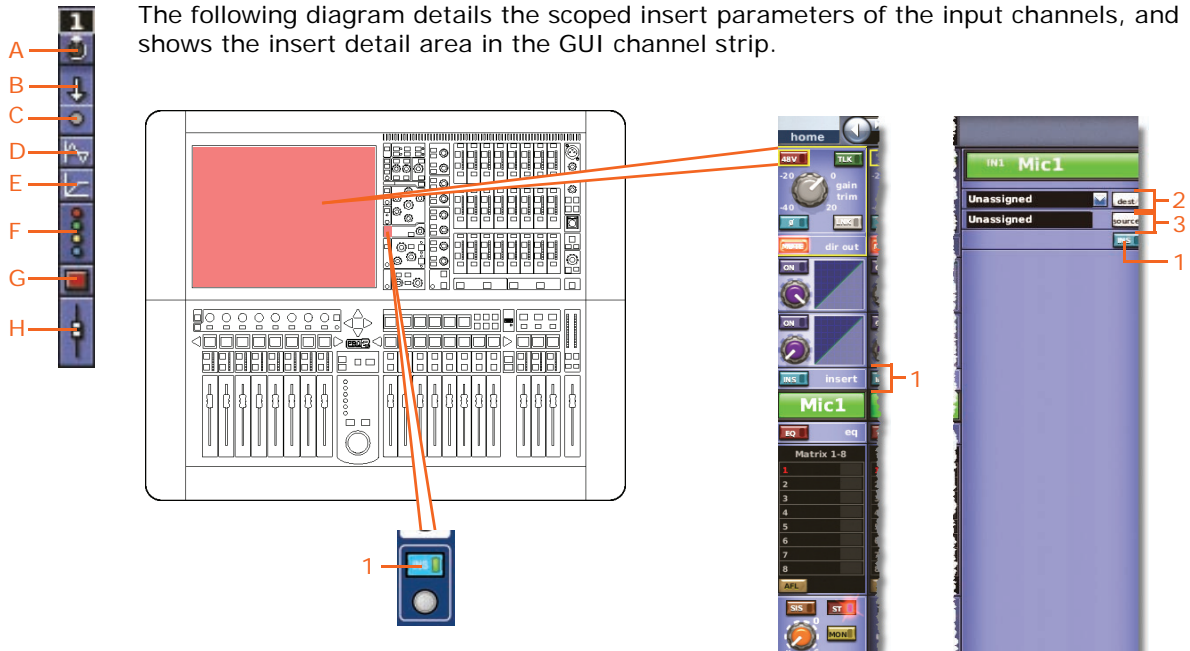

		A	B	C	D	E	F	G	H
<b>Item</b>	<b>Parameter</b>								
1	In/out	Yes	Yes	N/A	N/A	N/A	N/A	N/A	N/A
2	Insert send destination	N/A	No	N/A	N/A	N/A	N/A	N/A	N/A
3	Insert return source	N/A	No	N/A	N/A	N/A	N/A	N/A	N/A

EQ

The following diagram details the scoped parametric EQ parameters of the input channels, and shows the EQ detail area in the GUI channel strip.

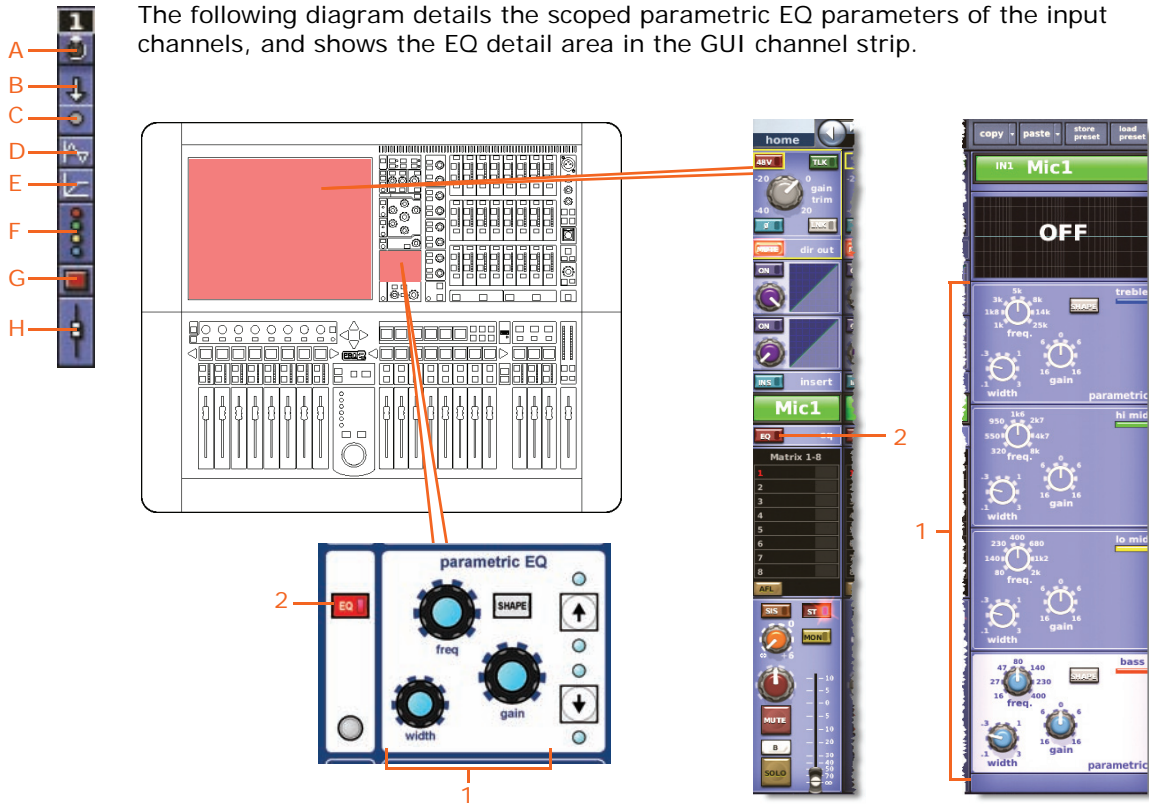

		A	B	C	D	E	F	G	H
<b>Item</b>	<b>Parameter</b>								
<b>1</b>	All filters: <b>freq, gain, width, SHAPE</b>	N/A	Yes	N/A	Yes	N/A	N/A	N/A	N/A
<b>2</b>	EQ in/out	N/A	Yes	N/A	Yes	N/A	N/A	N/A	N/A

Aux send

The following diagram details the scoped aux send **mix** section parameters of the input channels, and shows the mix detail area in the GUI channel strip. Although it only shows aux buses 1 to 8, it also applies to aux buses 9 to 32.

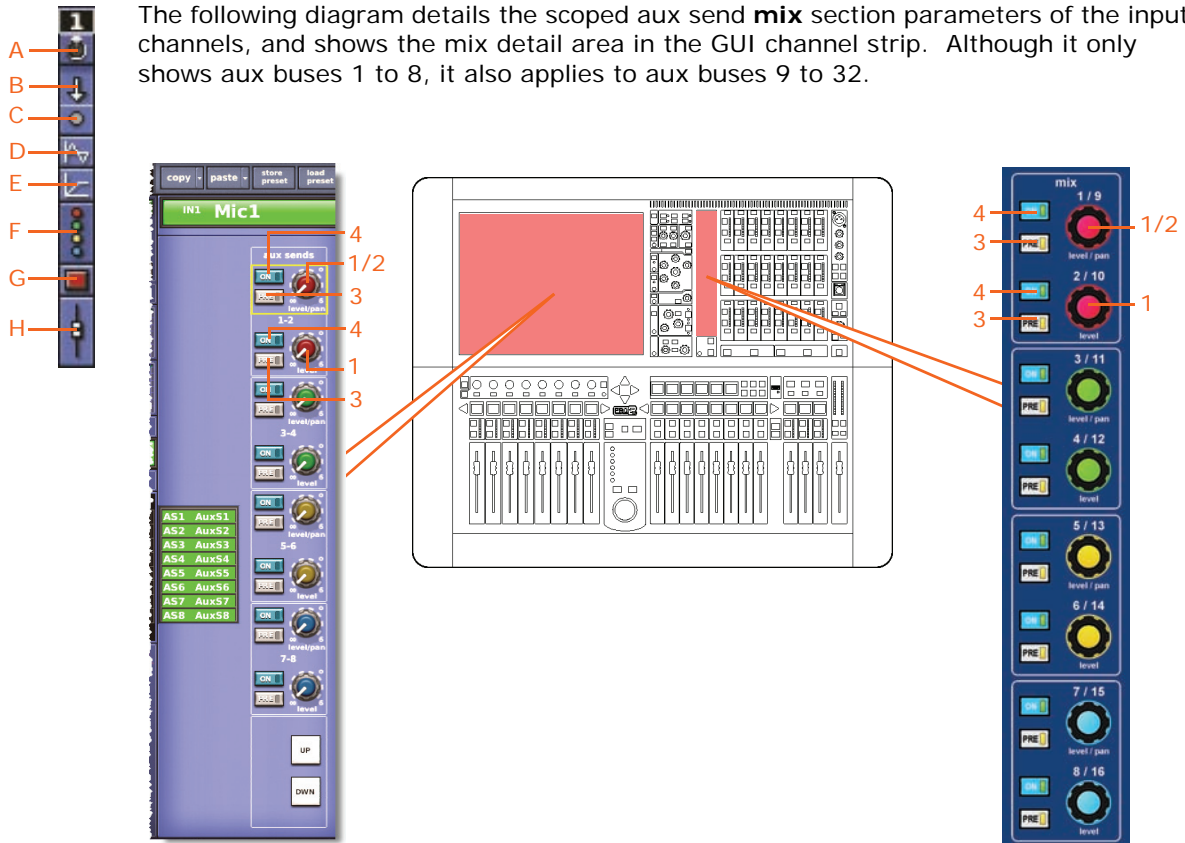

Item	Parameter	A	B	C	D	E	F	G	H
1	Send level	N/A	Yes	N/A	N/A	N/A	Yes	N/A	N/A
2	Send pan	N/A	Yes	N/A	N/A	N/A	Yes	N/A	N/A
3	Send pre-fader on/off	N/A	Yes	N/A	N/A	N/A	Yes	N/A	N/A
4	Send on/off	N/A	Yes	N/A	N/A	N/A	Yes	N/A	N/A

You can scope individual bus sends. In column **B (All)**, all sends are affected, and in column **F (Busses)**, individual sends can be scoped.

Matrix send

The following diagram details the scoped matrix send parameters in the **mix** section of the input channels, and shows the mix detail area in the GUI channel strip.

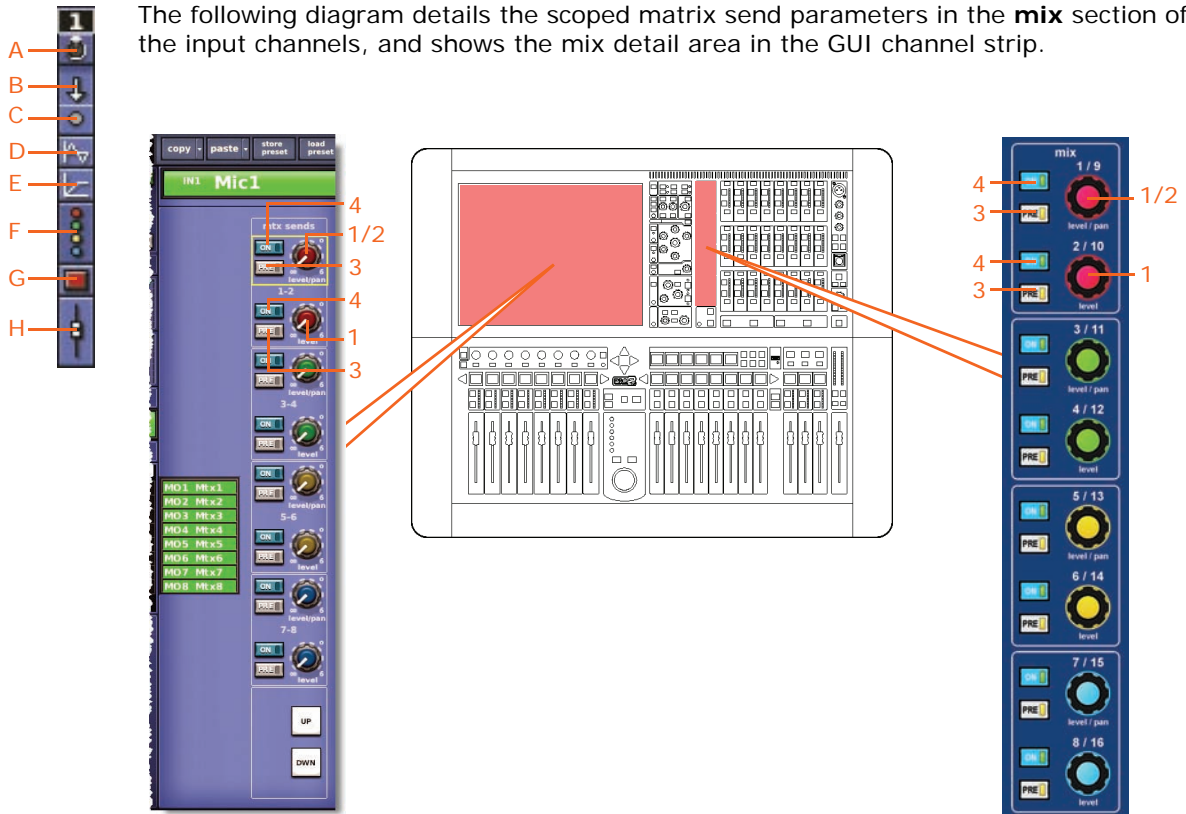

		A	B	C	E	D	F	G	H
<b>Item</b>	<b>Parameter</b>								
<b>1</b>	Send level	N/A	Yes	N/A	N/A	N/A	Yes	N/A	N/A
<b>2</b>	Send pan	N/A	Yes	N/A	N/A	N/A	Yes	N/A	N/A
<b>3</b>	Send pre-fader on/off	N/A	Yes	N/A	N/A	N/A	Yes	N/A	N/A
<b>4</b>	Send on/off	N/A	Yes	N/A	N/A	N/A	Yes	N/A	N/A







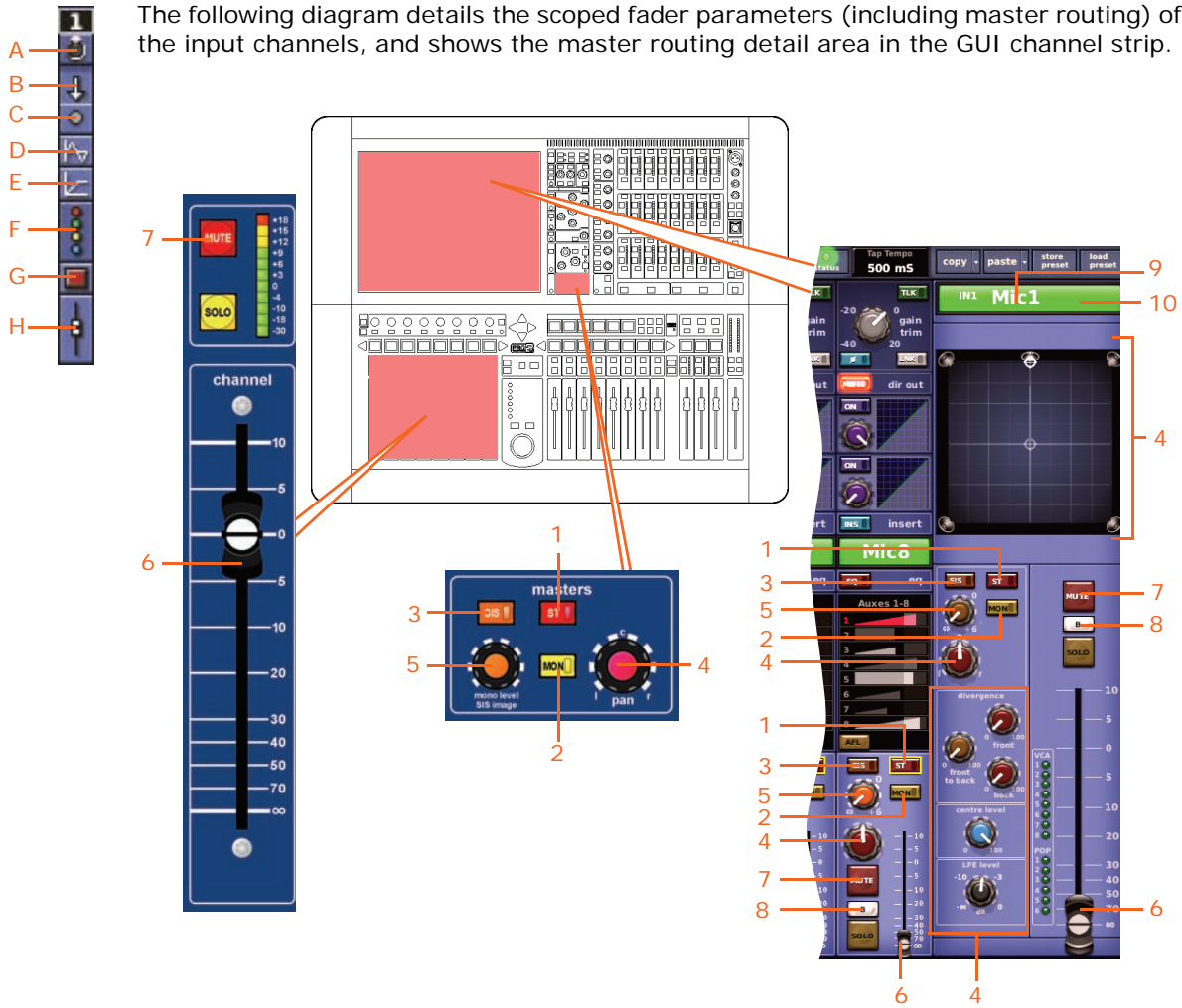

You can scope individual bus sends. In column **B (All)**, all sends are affected, and in column **F (Busses)**, individual sends can be scoped.

Fader

The following diagram details the scoped fader parameters (including master routing) of the input channels, and shows the master routing detail area in the GUI channel strip.



Item	Parameter	A	B	C	D	E	F	G	H
1	Stereo routing	N/A	Yes	N/A	N/A	N/A	N/A	N/A	Yes
2	Mono routing	N/A	Yes	N/A	N/A	N/A	N/A	N/A	Yes
3	SIS select (required for surround panning)	N/A	Yes	N/A	N/A	N/A	N/A	N/A	Yes
4	Pan (includes all surround sound parameters)	N/A	Yes	N/A	N/A	N/A	N/A	N/A	Yes
5	Mono level/SIS pan	N/A	Yes	N/A	N/A	N/A	N/A	N/A	Yes
6	Fader position	N/A	Yes	N/A	N/A	N/A	N/A	N/A	Yes
7	Channel mute	N/A	Yes	N/A	N/A	N/A	N/A	Yes	No
8	Solo B assignment	N/A	No	N/A	N/A	N/A	N/A	N/A	No

		A	B	C	D	E	F	G	H
									
<b>9</b>	Channel name	N/A	Yes	N/A	N/A	N/A	N/A	N/A	No
<b>10</b>	Channel colour	N/A	Yes	N/A	N/A	N/A	N/A	N/A	No

## Returns (Aux Returns)

Each scope screen has eight returns in the **Aux Returns** section.

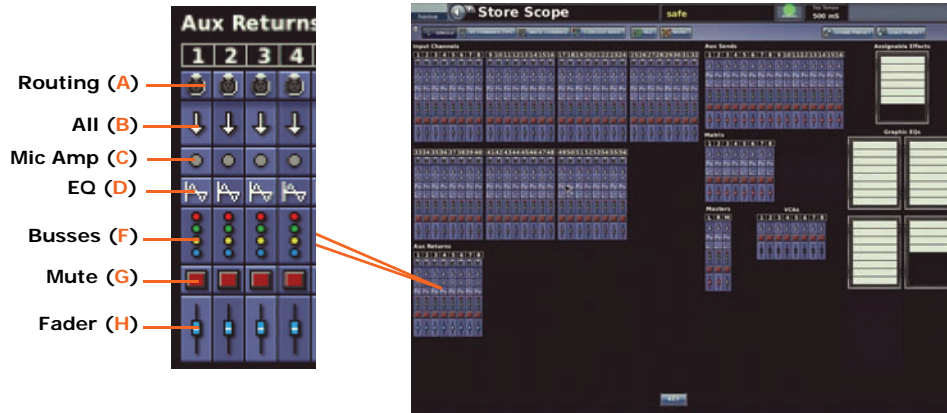

## Patching

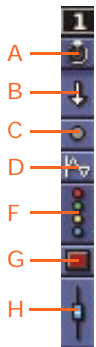

The following diagram details the scoped patching parameters of the return channels, and shows the configuration detail area in the GUI channel strip.

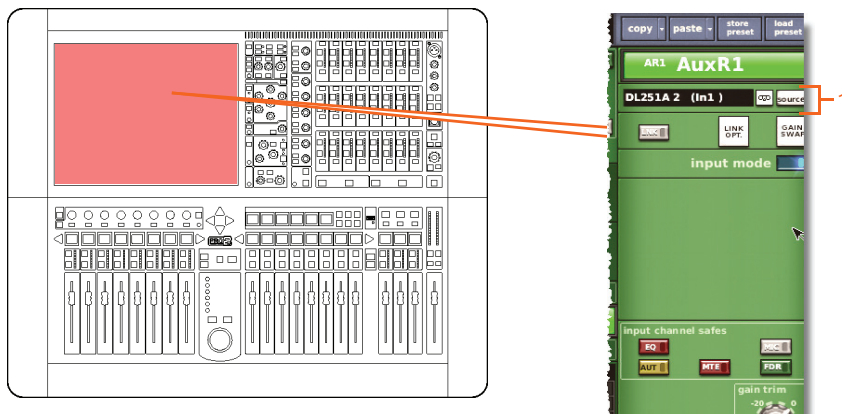

		A	B	C	D	F	G	H
<b>Item</b>	<b>Parameter</b>							
<b>1</b>	Input patching source	N/A	Yes <sup>1</sup>	N/A	N/A	N/A	N/A	N/A

1. Includes tape return and primary input sources.



Configuration

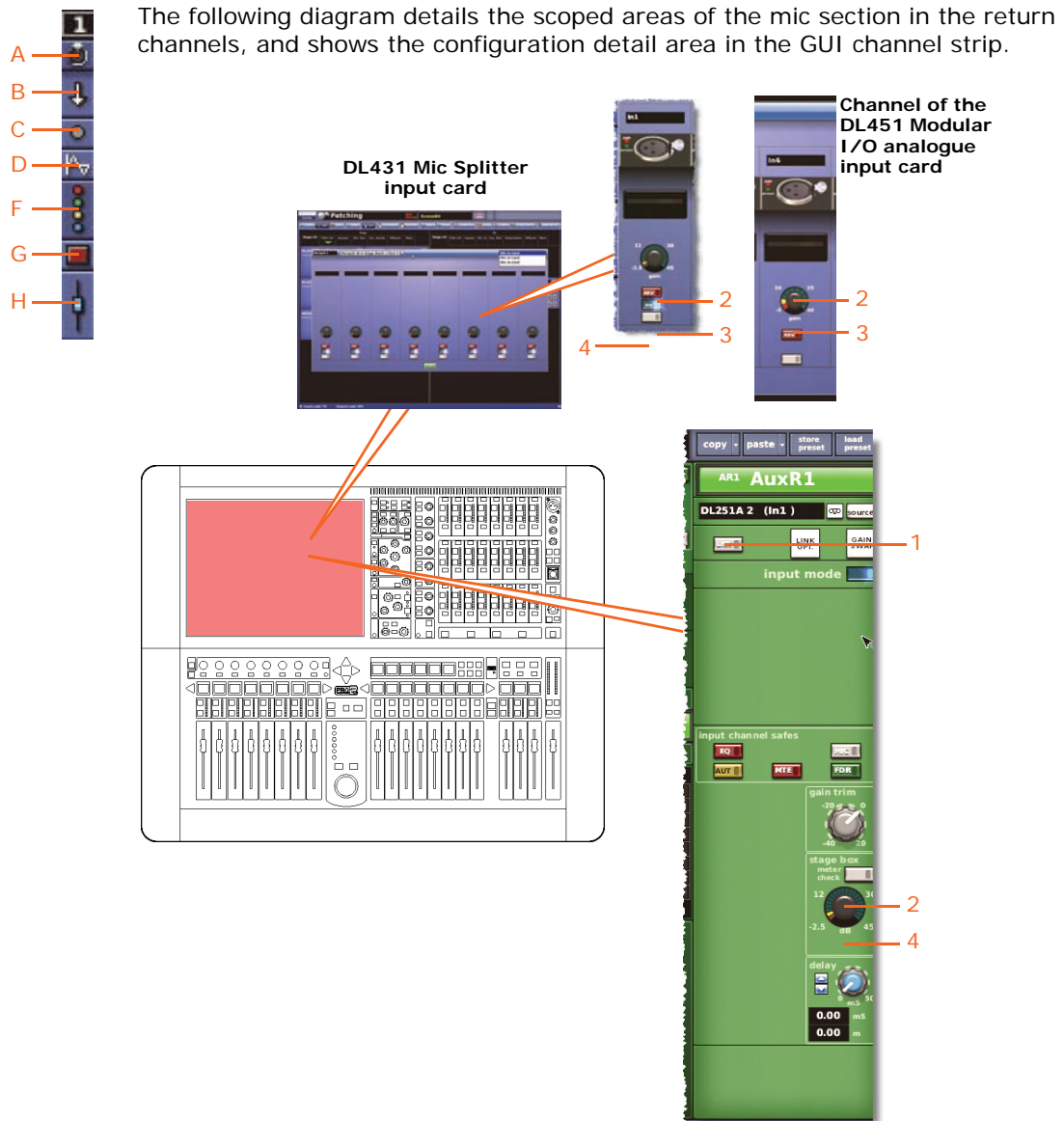

		A	B	C	D	F	G	H
<b>Item</b>	<b>Parameter</b>							
1	Link	N/A	No	No	No	No	No	No
2	Gain of remote amplifier	N/A	Yes	Yes	N/A	N/A	N/A	N/A
3	48V phantom gain	N/A	Yes	Yes	N/A	N/A	N/A	N/A
4	30Hz filter*	N/A	Yes	Yes	N/A	N/A	N/A	N/A

\* Only when sourced from a DL431 Mic Splitter.

**Dynamics**

Not applicable.

**Insert**

Not applicable.

**EQ**

The following diagram details the scoped parametric EQ parameters of the input channels, and shows the EQ detail area in the GUI channel strip.

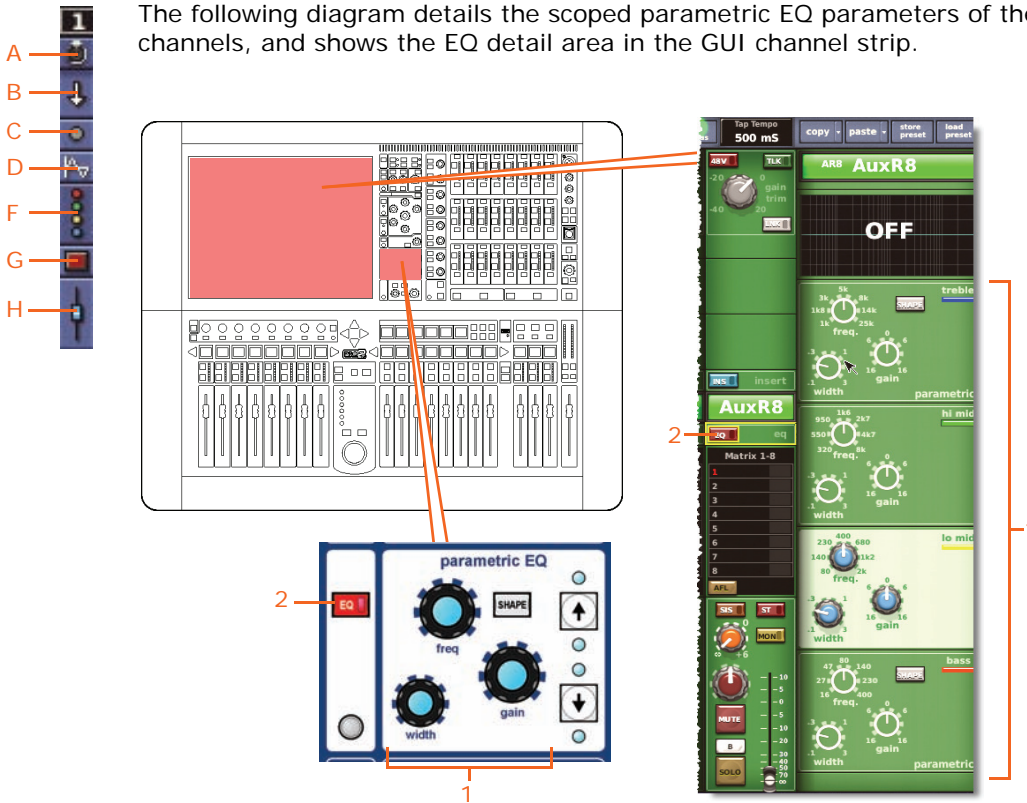

		A	B	C	D	F	G	H
<b>Item</b>	<b>Parameter</b>							
<b>1</b>	All filters: <b>freq, gain, width, SHAPE</b>	N/A	Yes	N/A	Yes	N/A	N/A	N/A
<b>2</b>	EQ in/out	N/A	Yes	N/A	Yes	N/A	N/A	N/A

Aux send

The following diagram details the scoped parameters of the return channels, and shows the aux send mix buses (mix detail area) in the GUI channel strip.

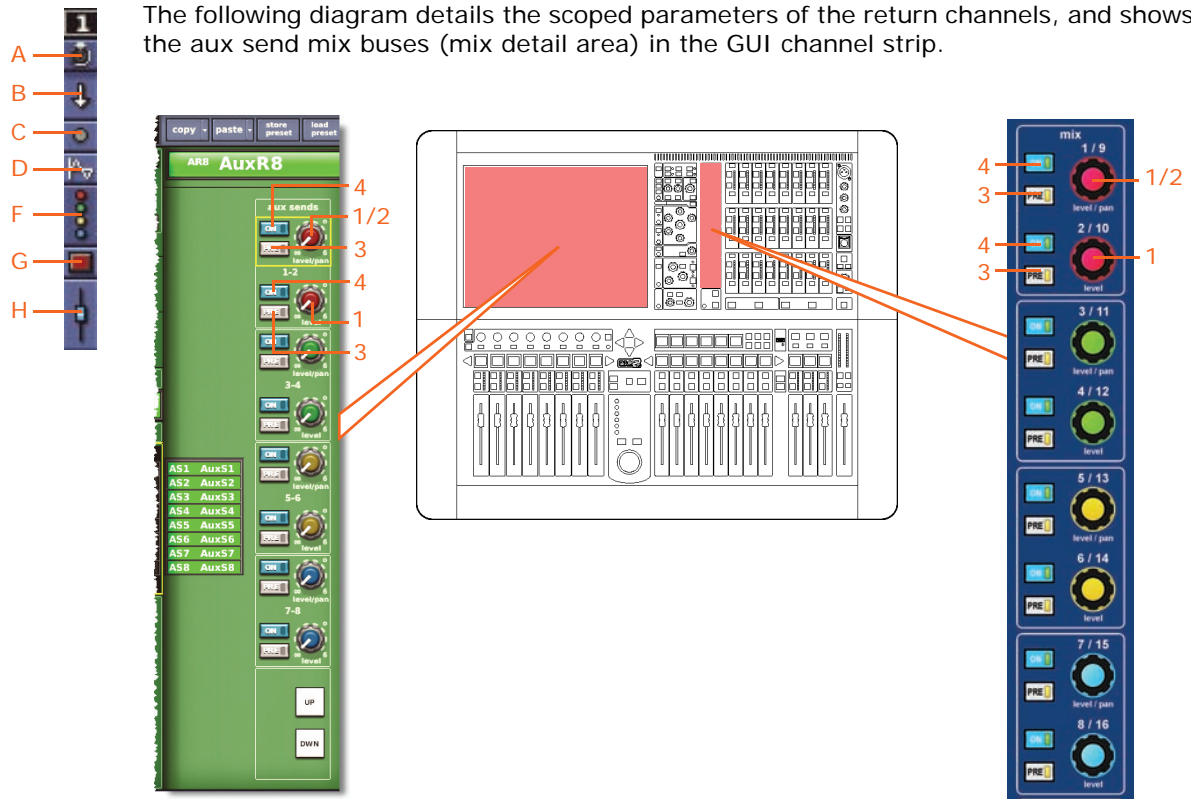

		A	B	C	D	F	G	H
<b>Item</b>	<b>Parameter</b>							
<b>1</b>	Send level	N/A	Yes	N/A	N/A	Yes	N/A	N/A
<b>2</b>	Send pan	N/A	Yes	N/A	N/A	Yes	N/A	N/A
<b>3</b>	Send pre-fader on/off	N/A	Yes	N/A	N/A	Yes	N/A	N/A
<b>4</b>	Send on/off	N/A	Yes	N/A	N/A	Yes	N/A	N/A

Matrix send

The following diagram details the scoped parameters in the return channels, and shows the matrix mix buses (mix detail area) in the GUI channel strip.

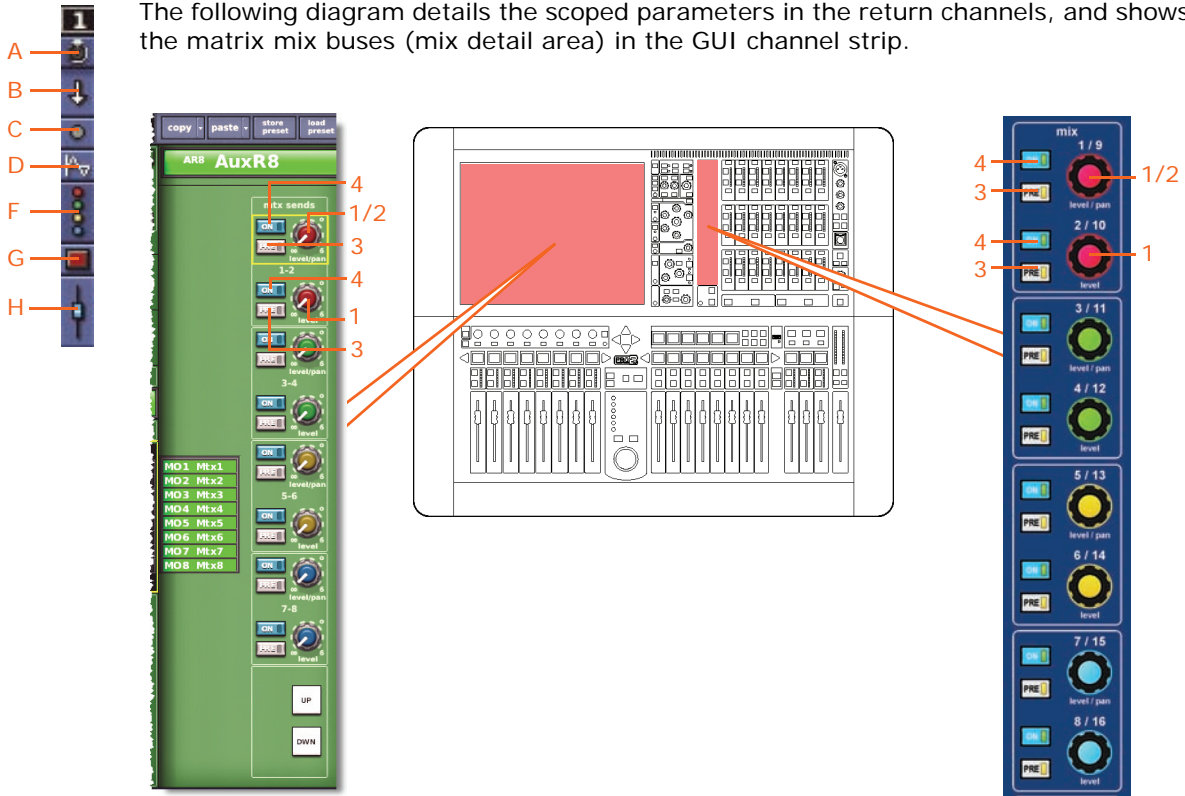

		A	B	C	D	F	G	H
<b>Item</b>	<b>Parameter</b>							
1	Send level	N/A	Yes	N/A	N/A	Yes	N/A	N/A
2	Send pan	N/A	Yes	N/A	N/A	Yes	N/A	N/A
3	Send pre-fader on/off	N/A	Yes	N/A	N/A	Yes	N/A	N/A
4	Send on/off	N/A	Yes	N/A	N/A	Yes	N/A	N/A

Fader

The following diagram details the scoped fader (including master routing) parameters of the return channels, and shows the master routing detail area in the GUI channel strip.

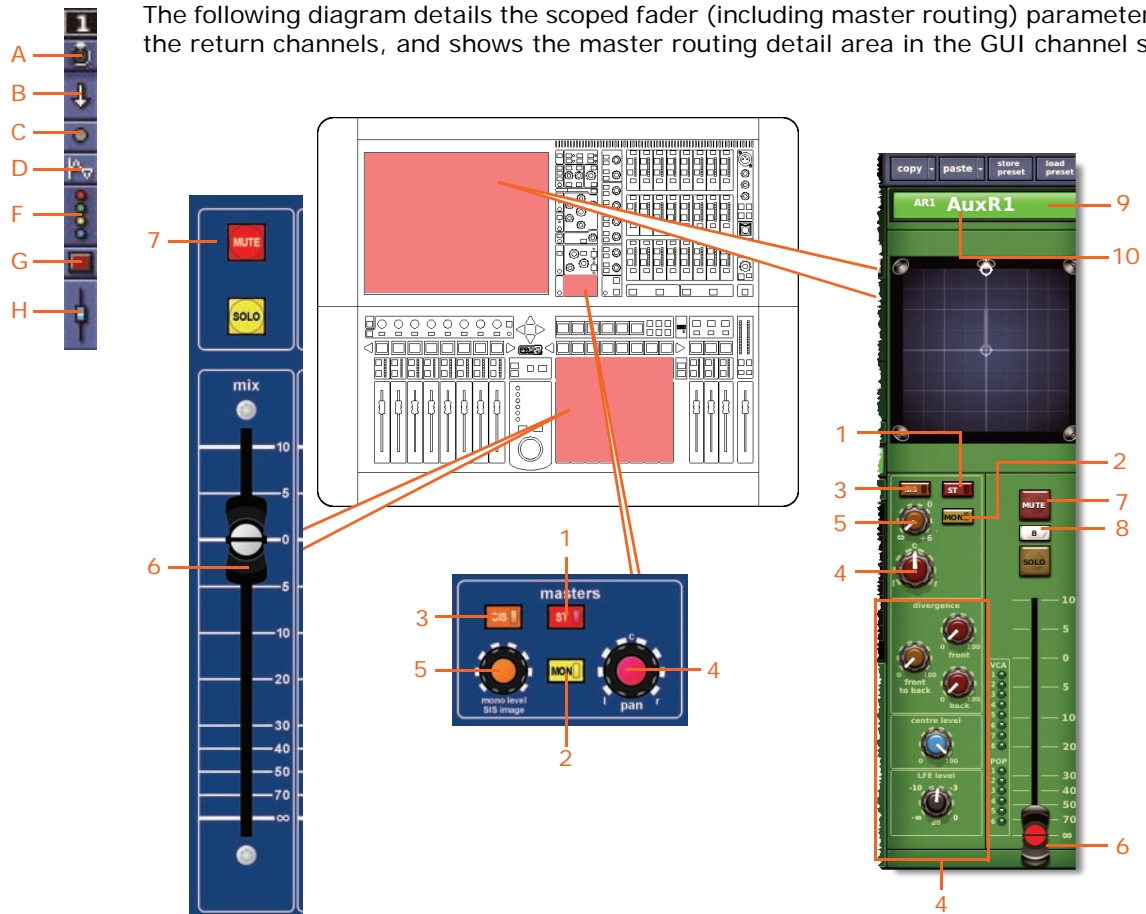

		A	B	C	D	F	G	H
<b>Item</b>	<b>Parameter</b>							
<b>1</b>	Stereo routing	N/A	Yes	N/A	N/A	N/A	N/A	Yes
<b>2</b>	Mono routing	N/A	Yes	N/A	N/A	N/A	N/A	Yes
<b>3</b>	SIS select (required for surround panning)	N/A	Yes	N/A	N/A	N/A	N/A	Yes
<b>4</b>	Pan (includes all surround sound parameters)	N/A	Yes	N/A	N/A	N/A	N/A	Yes
<b>5</b>	Mono level/SIS pan	N/A	Yes	N/A	N/A	N/A	N/A	Yes
<b>6</b>	Fader position	N/A	Yes	N/A	N/A	N/A	N/A	Yes
<b>7</b>	Channel mute	N/A	Yes	N/A	N/A	N/A	Yes	N/A
<b>8</b>	Solo B assignment	N/A	No	N/A	N/A	N/A	N/A	N/A
<b>9</b>	Channel name	N/A	Yes	N/A	N/A	N/A	N/A	N/A
<b>10</b>	Channel colour	N/A	Yes	N/A	N/A	N/A	N/A	N/A

## Auxes (Aux Sends)

Each scope screen has 16 auxes in the **Aux Sends** section.

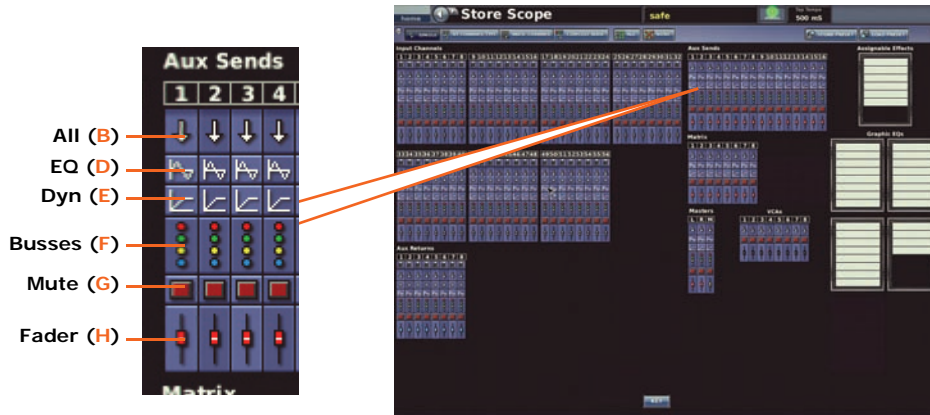

## Patching

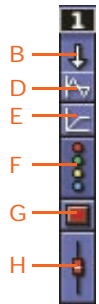



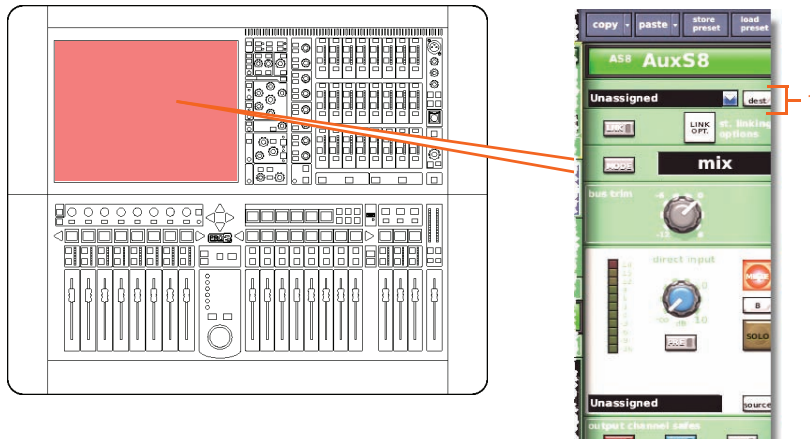



The following diagram details the scoped patching parameters of the aux channels, and shows the configuration detail area in the GUI channel strip.

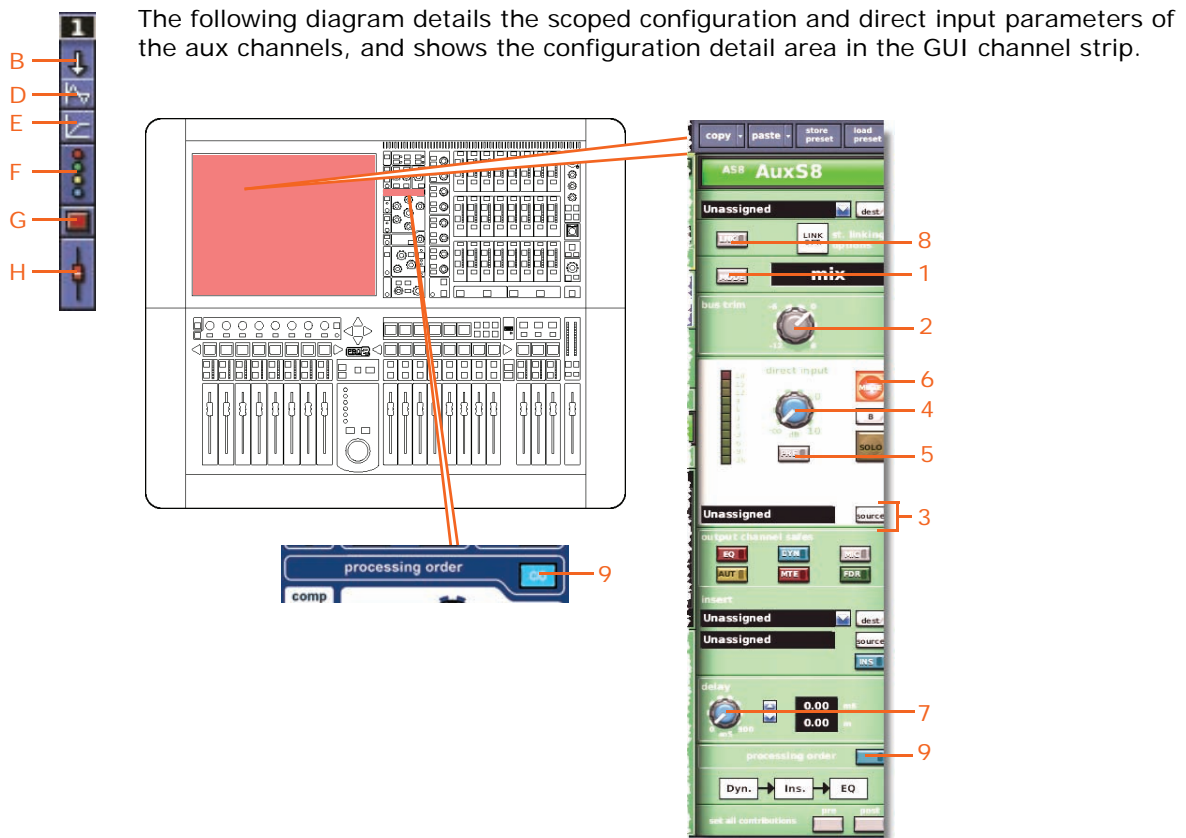

Item	Parameter	B	D	E	F	G	H
1	Output patching	No	N/A	N/A	N/A	N/A	N/A

Configuration



		B	D	E	F	G	H
							
1	Bus mode	Yes	N/A	N/A	N/A	N/A	Yes
2	Bus trim	Yes	N/A	N/A	N/A	N/A	Yes
3	Direct input source	Yes <sup>1</sup>	N/A	N/A	N/A	N/A	N/A
4	Direct input level	Yes	N/A	N/A	N/A	N/A	N/A
5	Direct input pre-/post-	Yes	N/A	N/A	N/A	N/A	N/A
6	Direct input mute	Yes	N/A	N/A	N/A	Yes	N/A
7	Delay	Yes	N/A	N/A	N/A	N/A	Yes
8	Link	No	No	No	No	No	No
9	Process order	Yes	Yes	N/A	N/A	N/A	N/A

1. Only when automate patching is on.



Dynamics

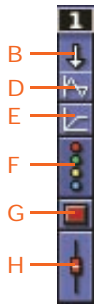

The following diagram details the scoped compressor parameters of the aux channels, and shows the compressor detail area in the GUI channel strip. Although only the corrective compressor is shown below, this is typically the same for the other compressor modes (adaptive, creative, vintage and shimmer).

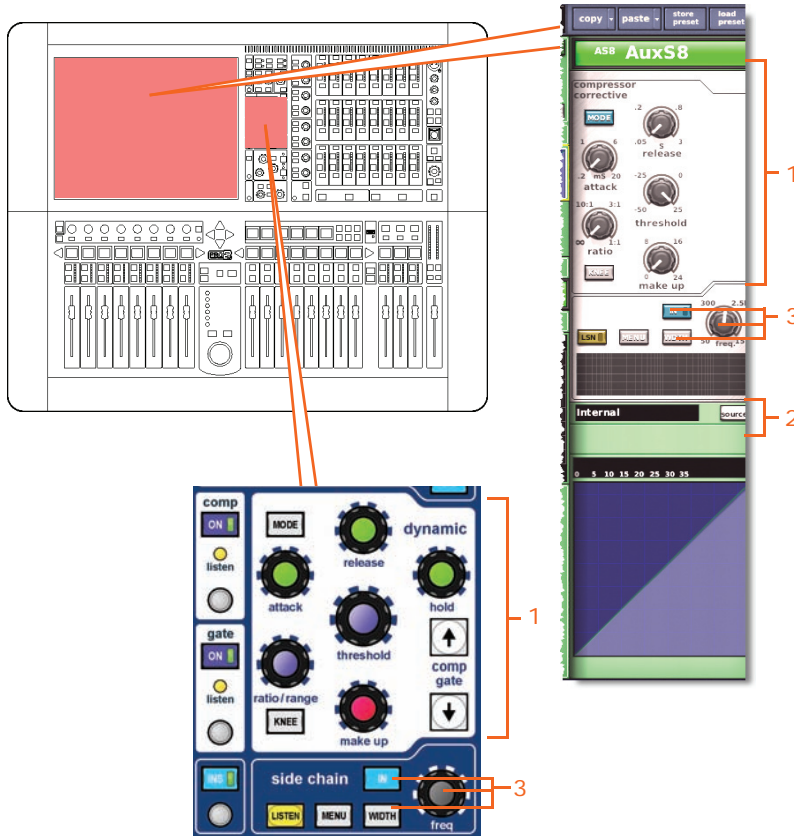







Item	Parameter	B	D	E	F	G	H
1	Compressor: <b>attack, release, threshold, ratio, make up, and KNEE</b>	Yes	N/A	Yes	N/A	N/A	N/A
2	Sidechain source	N/A	N/A	No	N/A	N/A	N/A
3	Compressor sidechain: <b>IN, freq, and WIDTH</b>	Yes	N/A	Yes	N/A	N/A	N/A

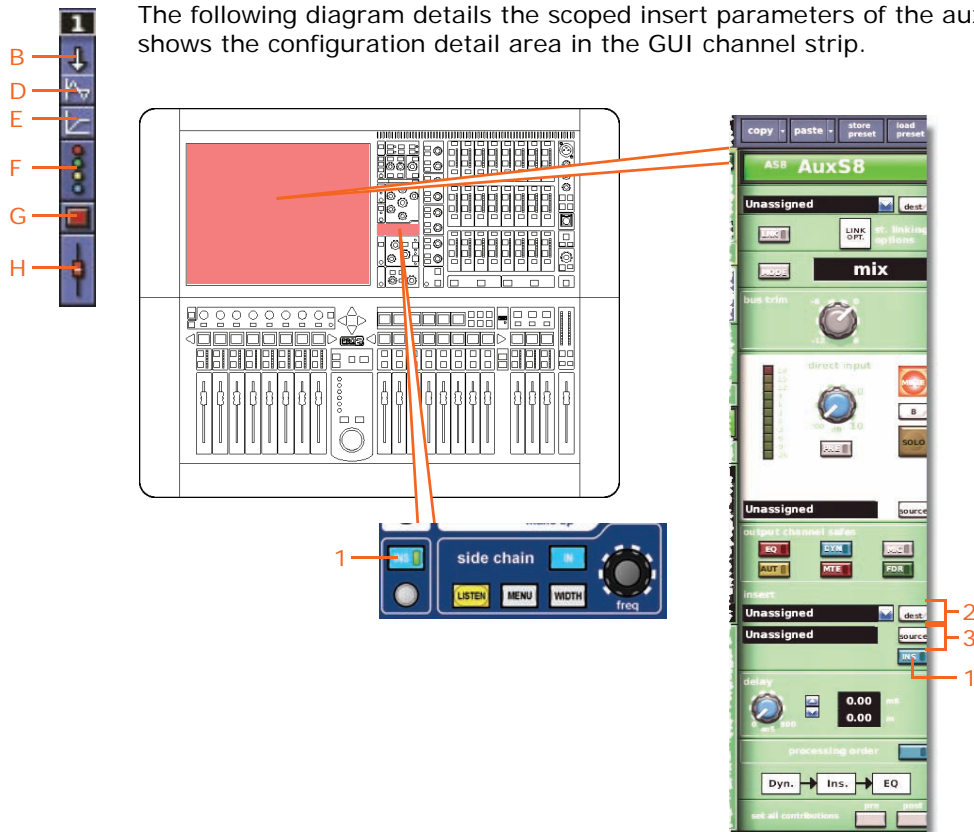

Insert

The following diagram details the scoped insert parameters of the aux channels, and shows the configuration detail area in the GUI channel strip.



		B	D	E	F	G	H
<i>Item</i>	<i>Parameter</i>						
1	In/out	Yes	N/A	N/A	N/A	N/A	N/A
2	Insert send destination	No	N/A	N/A	N/A	N/A	N/A
3	Insert return source	No	N/A	N/A	N/A	N/A	N/A

EQ

The following diagram details the scoped parameters in the EQ section of the aux channels, and shows the EQ detail area in the GUI channel strip.

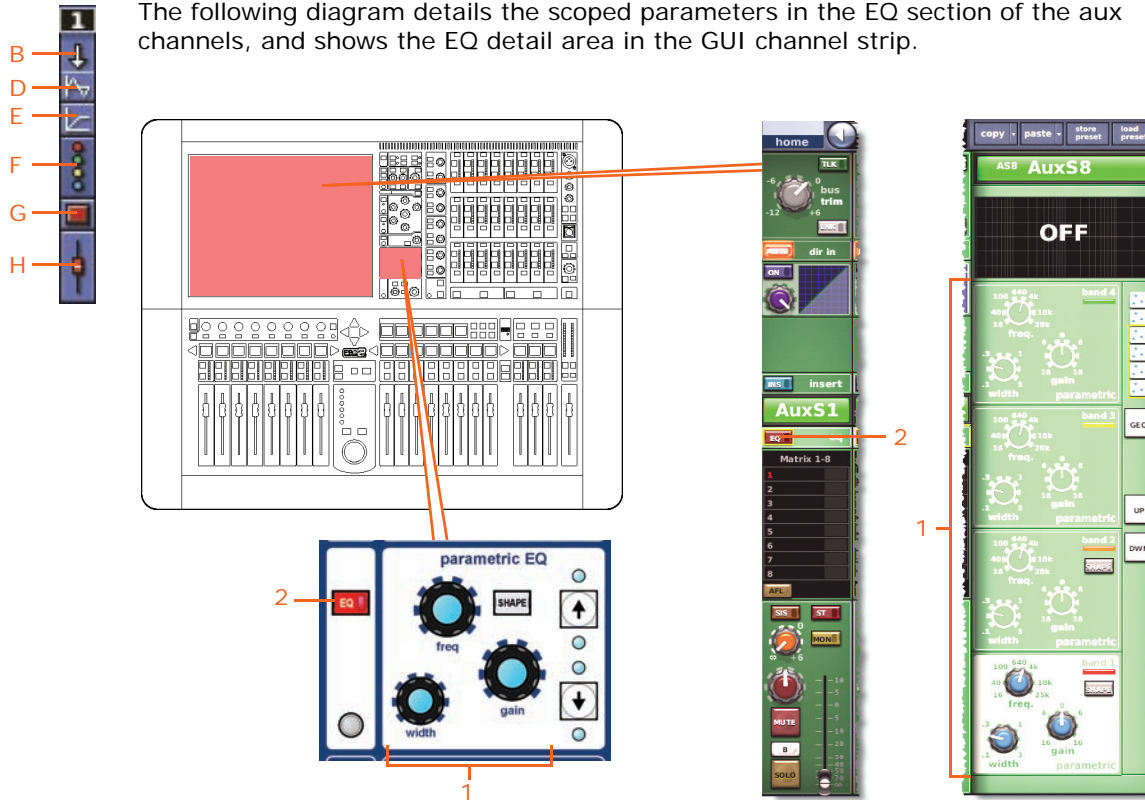

Item	Parameter						
		B	D	E	F	G	H
1	All PEQ filters (all six bands): <b>freq, gain, width, SHAPE</b> (as necessary)			N/A			
2	Parametric/Graphic type	No	No	N/A	N/A	N/A	N/A
3	EQ in/out	Yes	Yes	N/A	N/A	N/A	N/A

Aux send





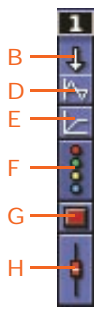

Not applicable.

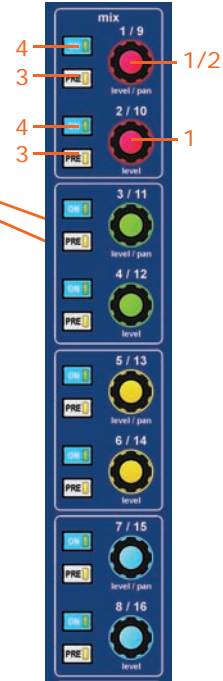
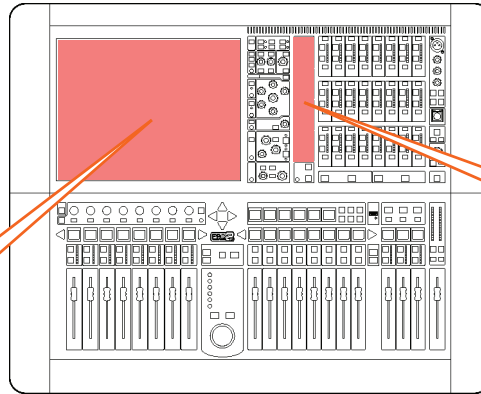
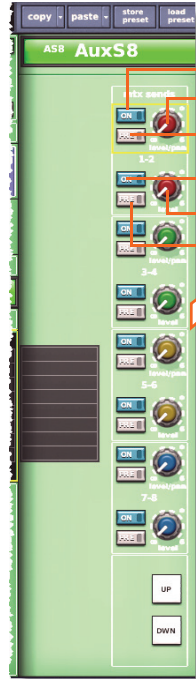
Matrix send



The following diagram details the scoped parameters in the **matrix** section of the aux channels, and shows the mix detail area in the GUI channel strip. Although only matrices 1 to 8 are shown below, this also applies to matrices 9 to 16.



Item	Parameter	B	D	E	F	G	H
							
1	Send level	Yes	N/A	N/A	Yes	N/A	N/A
2	Send pre-fader on/off	Yes	N/A	N/A	Yes	N/A	N/A
3	Send on/off	Yes	N/A	N/A	Yes	N/A	N/A

You can scope individual bus sends. In column **B (All)**, all sends are affected, and in column **F (Busses)**, individual sends can be scoped.

Fader

The following diagram details the scoped fader and master routing parameters of the aux channels, and shows the master routing detail area in the GUI channel strip.

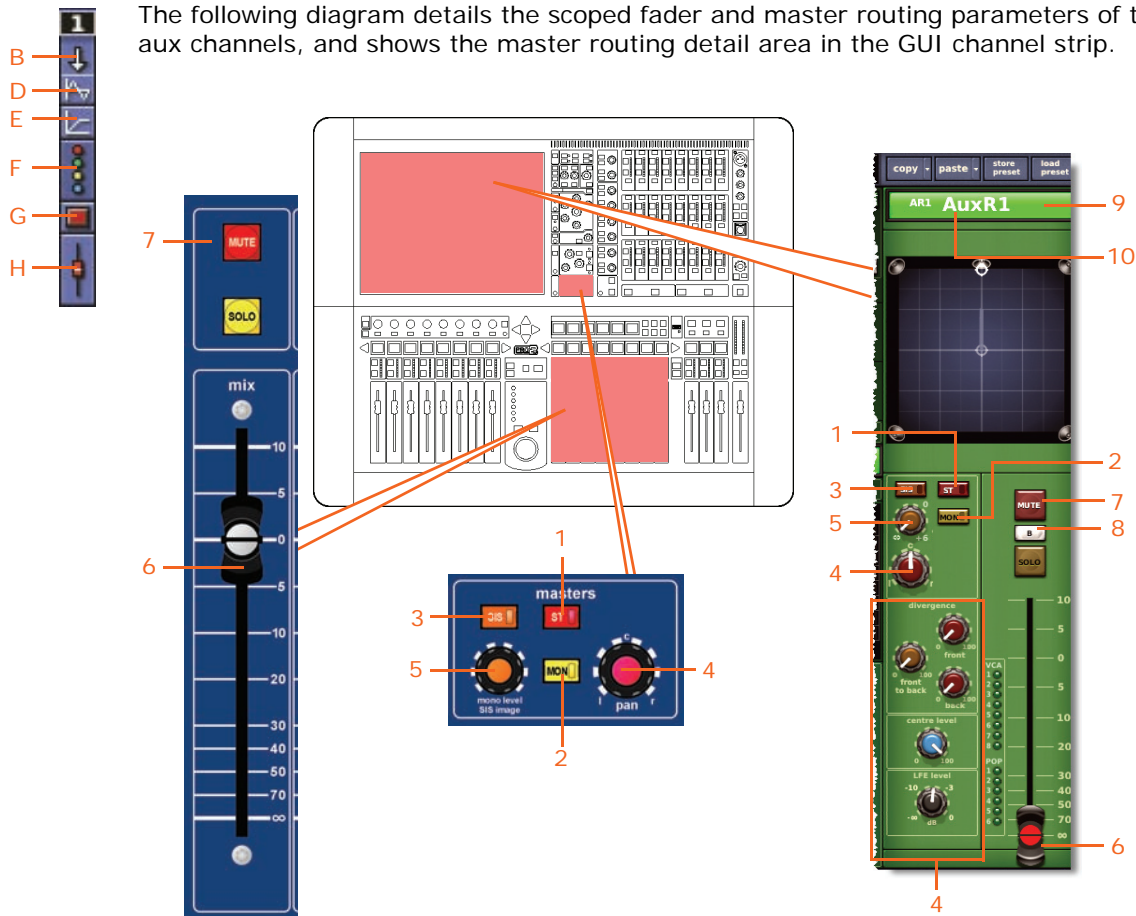

Item	Parameter	B	D	E	F	G	H
1	Stereo routing	Yes	N/A	N/A	N/A	N/A	Yes
2	Mono routing	Yes	N/A	N/A	N/A	N/A	Yes
3	SIS select (required for surround panning)	Yes	N/A	N/A	N/A	N/A	Yes
4	Pan (includes ALL surround sound parameters)	Yes	N/A	N/A	N/A	N/A	Yes
5	Mono level/SIS pan	Yes	N/A	N/A	N/A	N/A	Yes
6	Fader position	Yes	N/A	N/A	N/A	N/A	Yes
7	Channel mute	Yes	N/A	N/A	N/A	Yes	No
8	Solo B assignment	No	N/A	N/A	N/A	N/A	No
9	Channel name	Yes	N/A	N/A	N/A	N/A	No
10	Channel colour	Yes	N/A	N/A	N/A	N/A	No

## Matrices

Each scope screen has eight matrices in the **Matrix** section.



## Patching



The following diagram details the scoped patching parameters of the matrix channels, and shows the configuration detail area in the GUI channel strip.

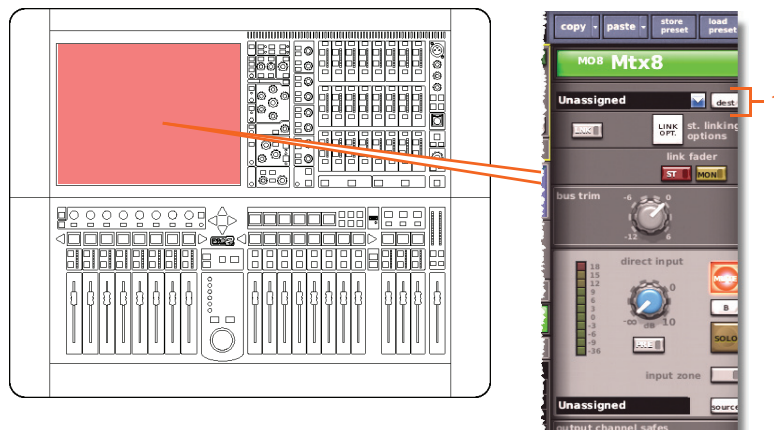

		B	D	E	G	H
<b>Item</b>	<b>Parameter</b>					
1	Output patching	No	N/A	N/A	N/A	N/A

Configuration



The following diagram details the scoped parameters of the configuration and direct input sections of the matrices channels, and shows the configuration detail area in the GUI channel strip.

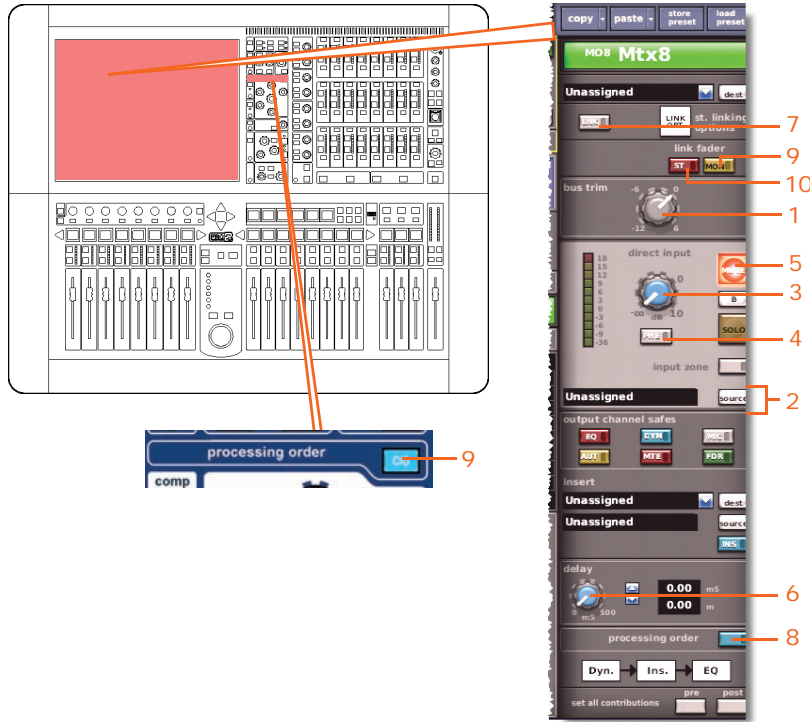

		B	D	E	G	H
<b>Item</b>	<b>Parameter</b>					
1	Bus trim	Yes	N/A	N/A	N/A	Yes
2	Direct input source	Yes <sup>1</sup>	N/A	N/A	N/A	N/A
3	Direct input level	Yes	N/A	N/A	N/A	N/A
4	Direct input pre-/post-	Yes	N/A	N/A	N/A	N/A
5	Direct input mute	Yes	N/A	N/A	Yes	N/A
6	Delay	Yes	N/A	N/A	N/A	Yes
7	Link	No	No	No	No	No
8	Process order	Yes	Yes	N/A	N/A	N/A
9	Link fader mono	Yes	N/A	N/A	N/A	Yes
10	Link fader stereo	Yes	N/A	N/A	N/A	Yes

1. Only when automate patching is on.

Dynamics



The following diagram details the scoped compressor parameters of the matrix channels, and shows the compressor detail area in the GUI channel strip. Although only the corrective compressor is shown below, this is typically the same for the other compressor modes (adaptive, creative, vintage and shimmer).

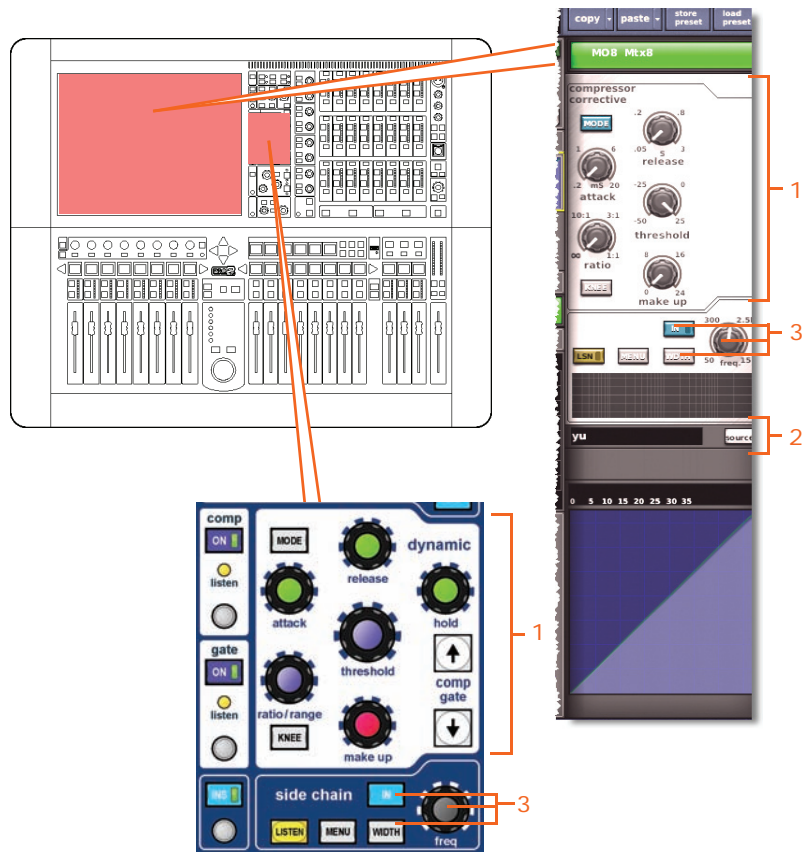







		B	D	E	G	H
<b>Item</b>	<b>Parameter</b>					
<b>1</b>	Compressor: <b>attack, release, threshold, ratio, make up, KNEE, MODE</b>	Yes	N/A	Yes	N/A	N/A
<b>2</b>	Sidechain source	No	N/A	No	N/A	N/A
<b>3</b>	Compressor sidechain: <b>IN, freq, and WIDTH</b>	Yes	N/A	Yes	N/A	N/A

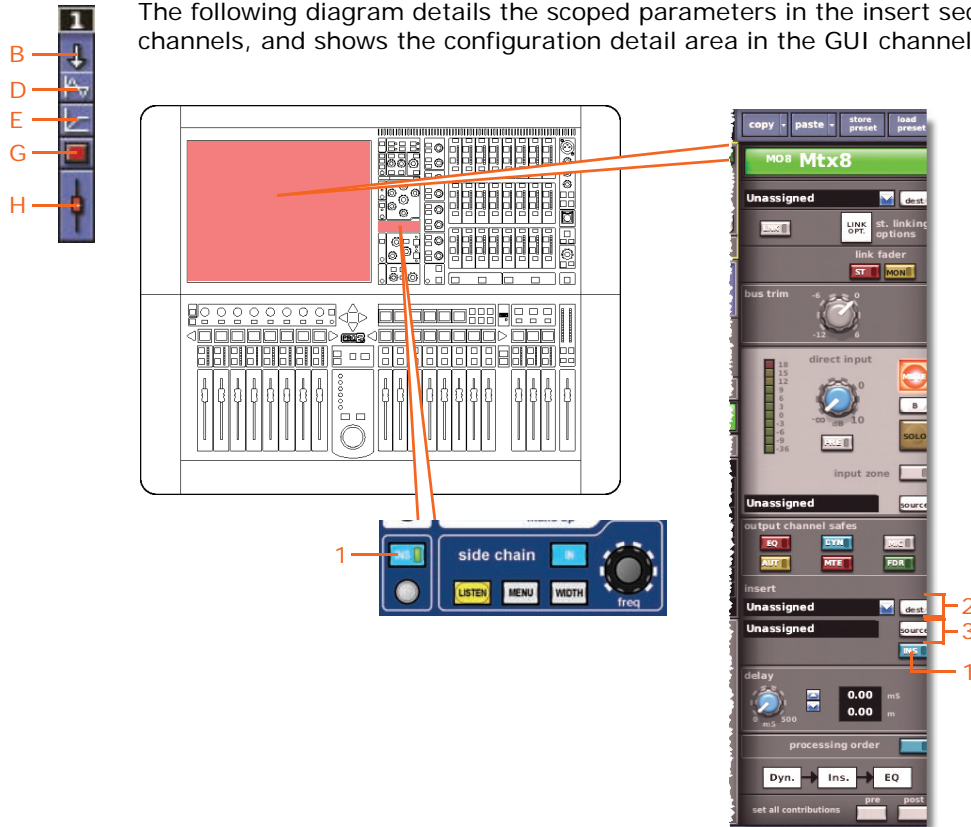

Insert

The following diagram details the scoped parameters in the insert section of the matrix channels, and shows the configuration detail area in the GUI channel strip.



		B	D	E	G	H
<b>Item</b>	<b>Parameter</b>					
1	In/out	Yes	N/A	N/A	N/A	N/A
2	Insert send destination	No	N/A	N/A	N/A	N/A
3	Insert return source	No	N/A	N/A	N/A	N/A



EQ



The following diagram details the scoped EQ parameters of the matrix channels, and shows the EQ detail area in the GUI channel strip.

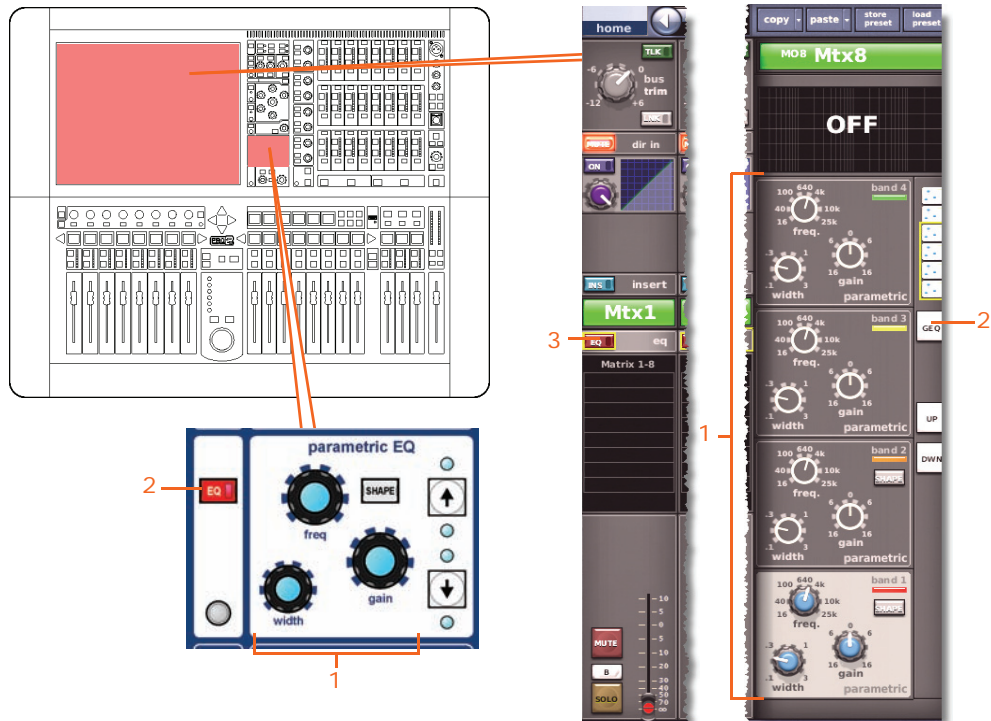

		B	D	E	G	H
<b>Item</b>	<b>Parameter</b>					
<b>1</b>	All PEQ filters (all six bands): <b>freq, gain, width, SHAPE</b> (as necessary)	Yes	Yes	N/A	N/A	N/A
<b>2</b>	Parametric/Graphic type	No	No	N/A	N/A	N/A
<b>3</b>	EQ in/out	Yes	Yes	N/A	N/A	N/A

Aux send

Not applicable.

Matrix send

Not applicable.

Fader

The following diagram details the scoped fader parameters of the matrix channels, and shows the fader detail area.

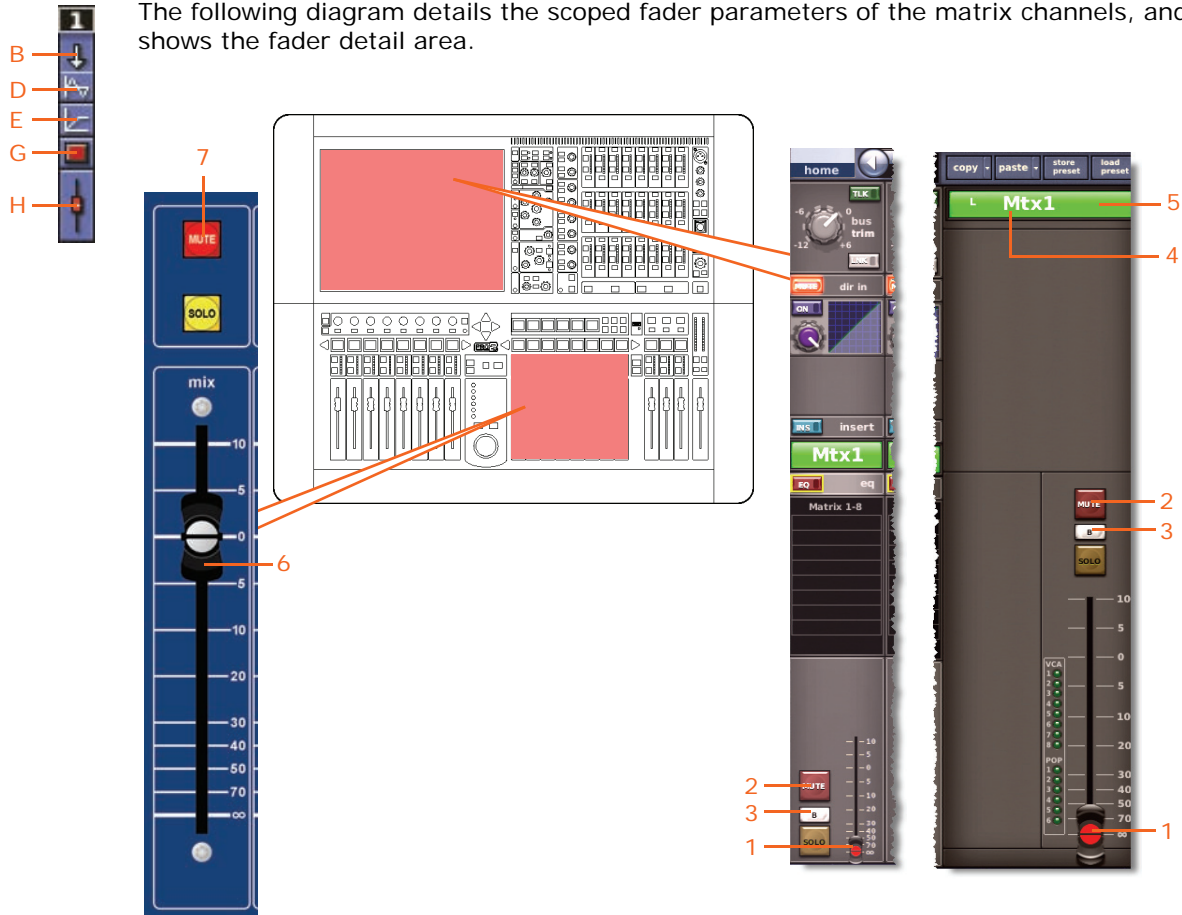

Item	Parameter	B	D	E	G	H
1	Fader position	Yes	N/A	N/A	N/A	Yes
2	Channel mute	Yes	N/A	N/A	Yes	No
3	Solo B assignment	No	N/A	N/A	N/A	No
4	Channel name	Yes	N/A	N/A	N/A	No
5	Channel colour	Yes	N/A	N/A	N/A	No

## Masters

Each scope screen has three master channels (stereo left and right, and mono) in the **masters** section.



## Patching

The following diagram details the scoped patching parameters of the master channels, and shows the configuration detail area in the GUI channel strip.

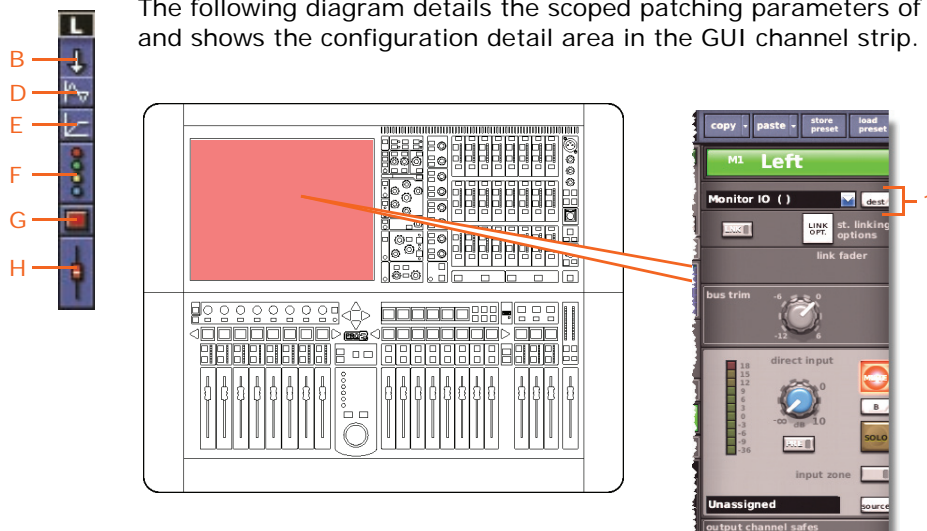

Item	Parameter	B	D	E	F	G	H
1	Output patching	No	N/A	N/A	N/A	N/A	N/A

Configuration

The following diagram details the scoped parameters in the configuration and direct input section of the master channels, and shows the configuration detail area in the GUI channel strip.

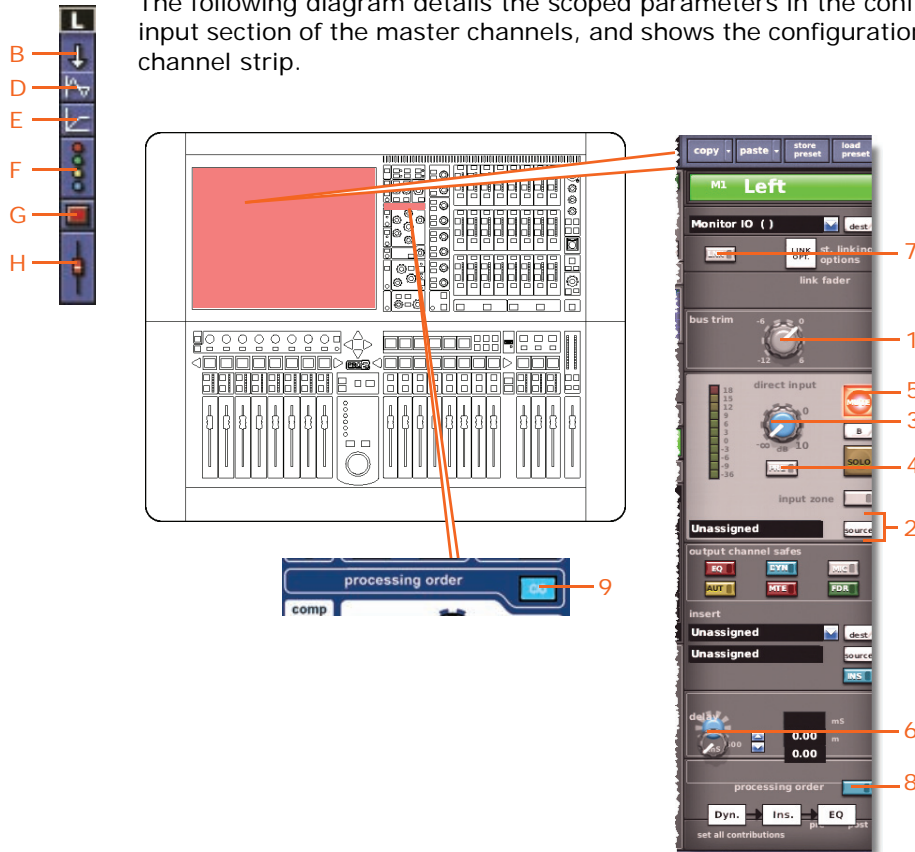

		B	D	E	F	G	H
<b>1</b>	Bus trim	Yes	N/A	N/A	N/A	N/A	Yes
<b>2</b>	Direct input source	Yes <sup>1</sup>	N/A	N/A	N/A	N/A	N/A
<b>3</b>	Direct input level	Yes	N/A	N/A	N/A	N/A	N/A
<b>4</b>	Direct input pre-/post-	Yes	N/A	N/A	N/A	N/A	N/A
<b>5</b>	Direct input mute	Yes	N/A	N/A	N/A	Yes	N/A
<b>6</b>	Delay	Yes	N/A	N/A	N/A	N/A	Yes
<b>7</b>	Link	No	No	No	No	No	No
<b>8</b>	Process order	Yes	Yes	N/A	N/A	N/A	N/A

1. Only when automate patching is on.

Dynamics

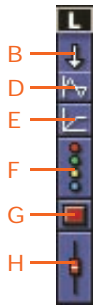

The following diagram details the scoped compressor parameters of the master channels, and shows the compressor detail area in the GUI channel strip. Although only the corrective compressor is shown below, this is typically the same for the other compressor modes (adaptive, creative, vintage and shimmer).

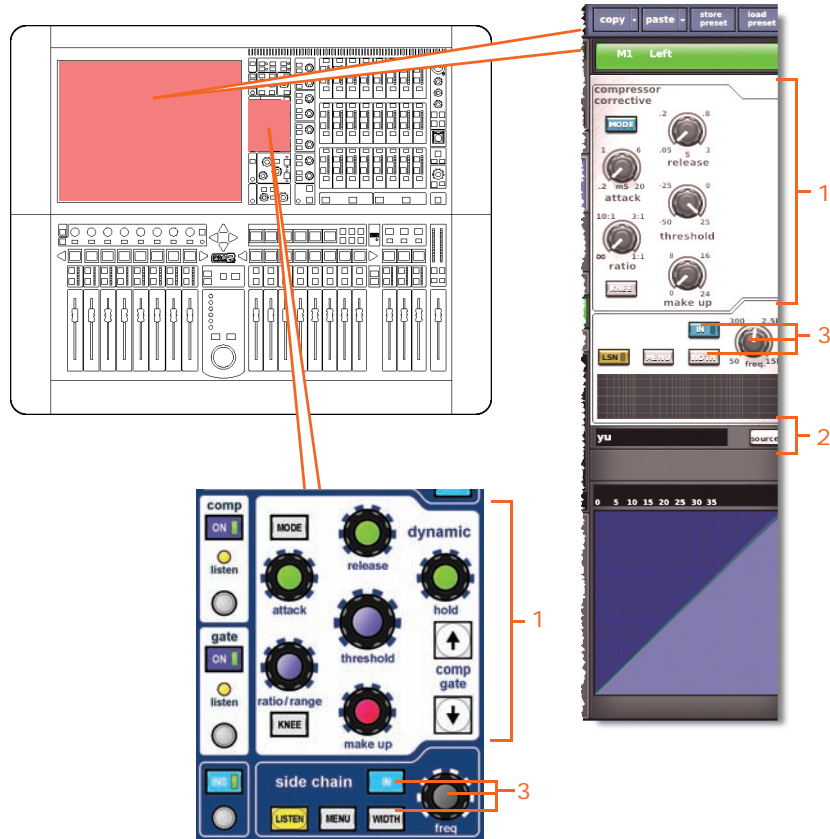





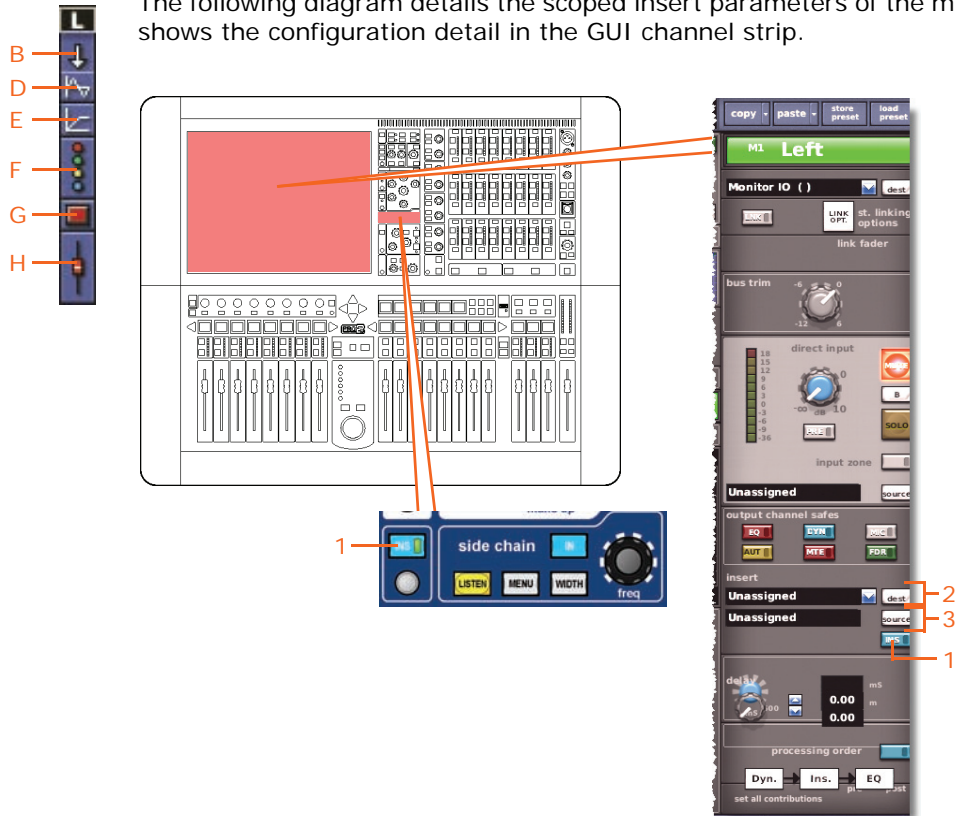

		B	D	E	F	G	H
<b>Item</b>	<b>Parameter</b>						
<b>1</b>	Compressor: <b>attack, release, threshold, ratio, make up</b> (gain), <b>KNEE, MODE</b>	Yes	N/A	Yes	N/A	N/A	N/A
<b>2</b>	Sidechain source	N/A	N/A	No	N/A	N/A	N/A
<b>3</b>	Compressor sidechain: <b>IN, freq,</b> and <b>WIDTH</b>	Yes	N/A	Yes	N/A	N/A	N/A

Insert

The following diagram details the scoped insert parameters of the master channels, and shows the configuration detail in the GUI channel strip.







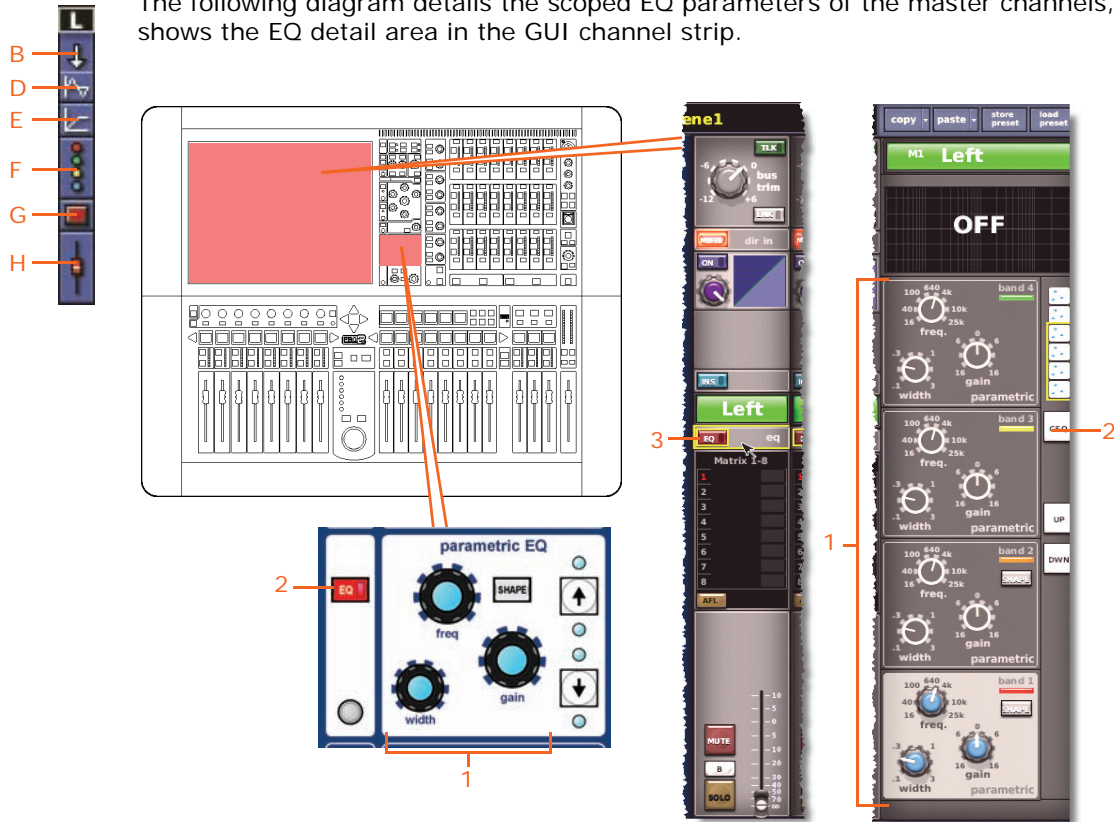

		B	D	E	F	G	H
<b>Item</b>	<b>Parameter</b>						
1	In/out	Yes	N/A	N/A	N/A	N/A	N/A
2	Insert send destination	No	N/A	N/A	N/A	N/A	N/A
3	Insert return source	No	N/A	N/A	N/A	N/A	N/A

EQ

The following diagram details the scoped EQ parameters of the master channels, and shows the EQ detail area in the GUI channel strip.



		B	D	E	F	G	H
<b>Item</b>	<b>Parameter</b>						
<b>1</b>	All PEQ filters (all six bands): <b>freq, gain, width, SHAPE</b> (as necessary)	Yes	Yes	N/A	N/A	N/A	N/A
<b>2</b>	Parametric/Graphic type	No	No	N/A	N/A	N/A	N/A
<b>3</b>	EQ in/out	Yes	Yes	N/A	N/A	N/A	N/A

Aux send







Not applicable

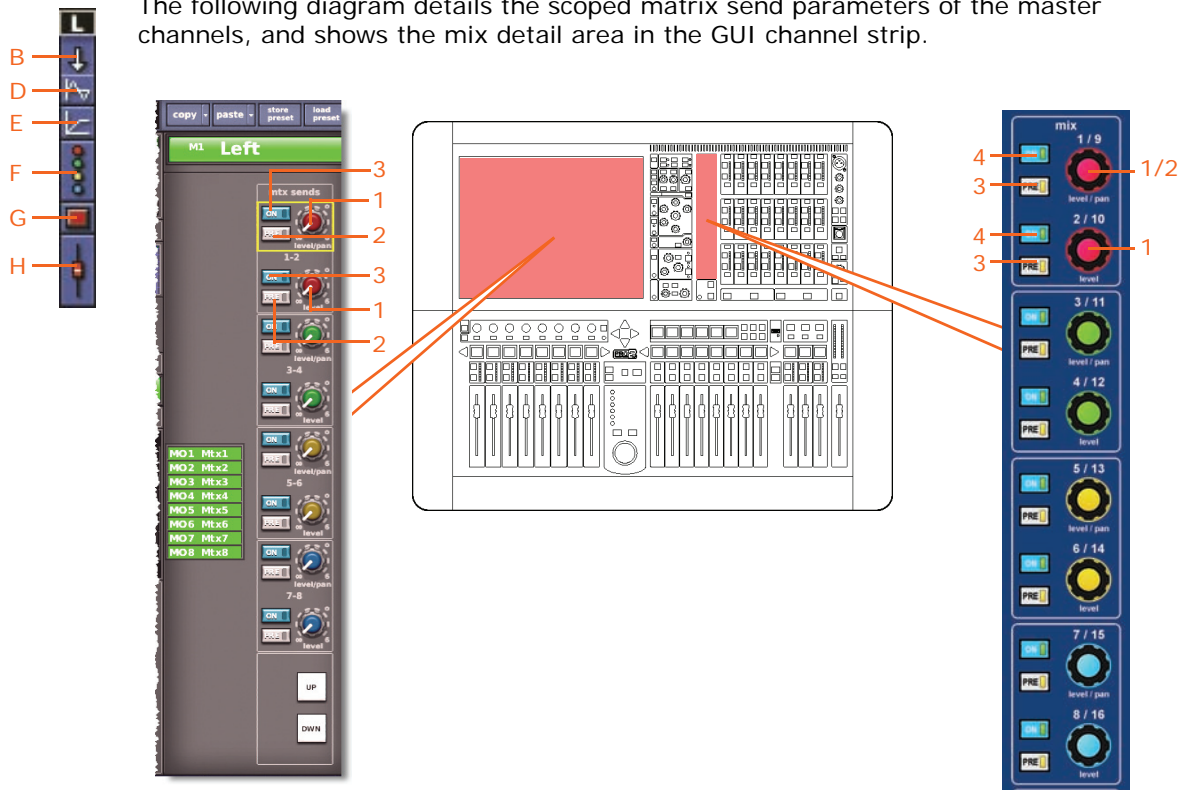

Matrix send

The following diagram details the scoped matrix send parameters of the master channels, and shows the mix detail area in the GUI channel strip.



Item	Parameter	B	D	E	F	G	H
							
1	Send level	Yes	N/A	N/A	Yes	N/A	N/A
2	Send pre-fader on/off	Yes	N/A	N/A	Yes	N/A	N/A
3	Send on/off	Yes	N/A	N/A	Yes	N/A	N/A







You can scope individual bus sends. In column **B (All)**, all sends are affected, and in column **F (Busses)**, individual sends can be scoped.

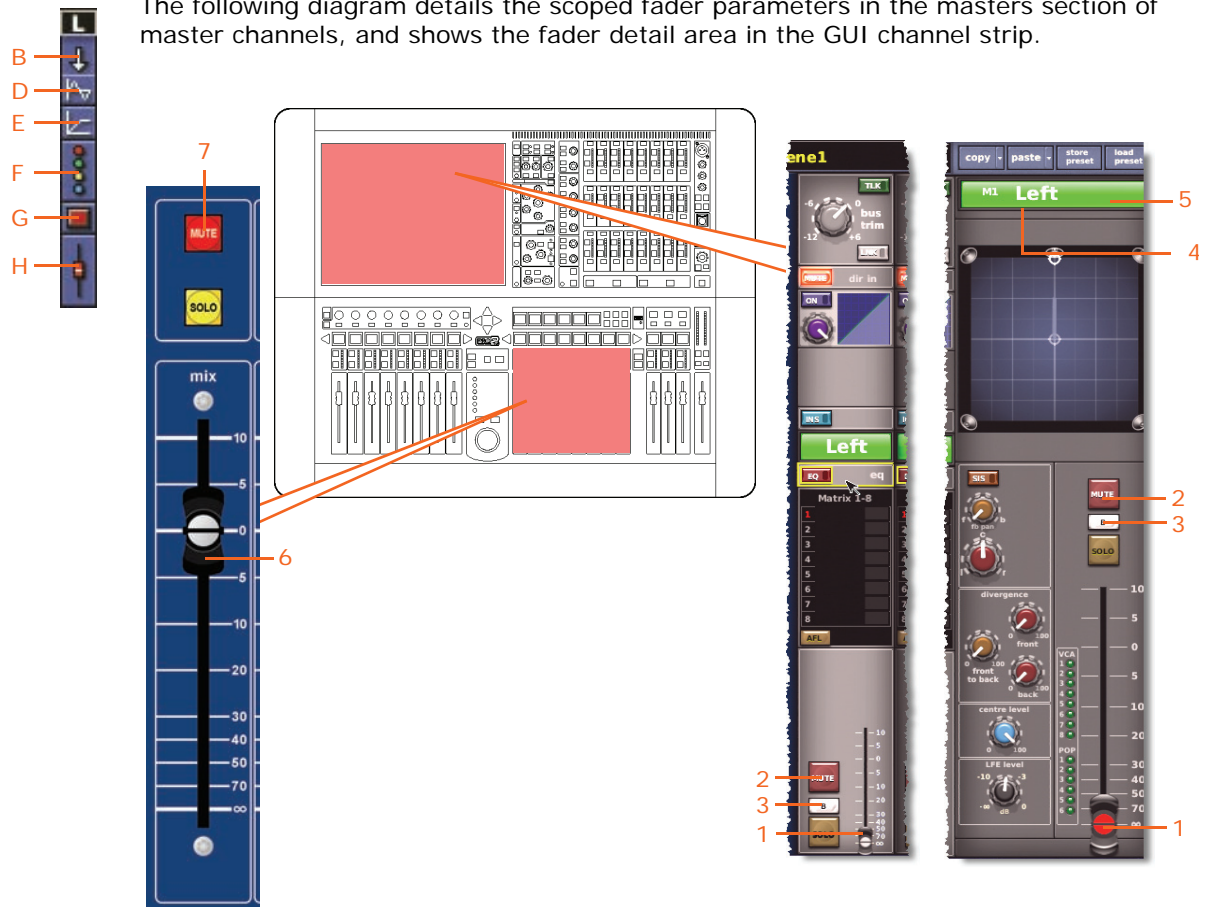

Fader

The following diagram details the scoped fader parameters in the masters section of master channels, and shows the fader detail area in the GUI channel strip.



		B	D	E	F	G	H
							
<b>1</b>	Fader position	Yes	N/A	N/A	N/A	N/A	Yes
<b>2</b>	Channel mute	Yes	N/A	N/A	N/A	Yes	No
<b>3</b>	Solo B assignment	No	N/A	N/A	N/A	N/A	No
<b>4</b>	Channel name	Yes	N/A	N/A	N/A	N/A	No
<b>5</b>	Channel colour	Yes	N/A	N/A	N/A	N/A	No

### GEQ rack

Each scope screen has a user-configurable rack of up to 28 GEQs in the **Graphic EQs** section.

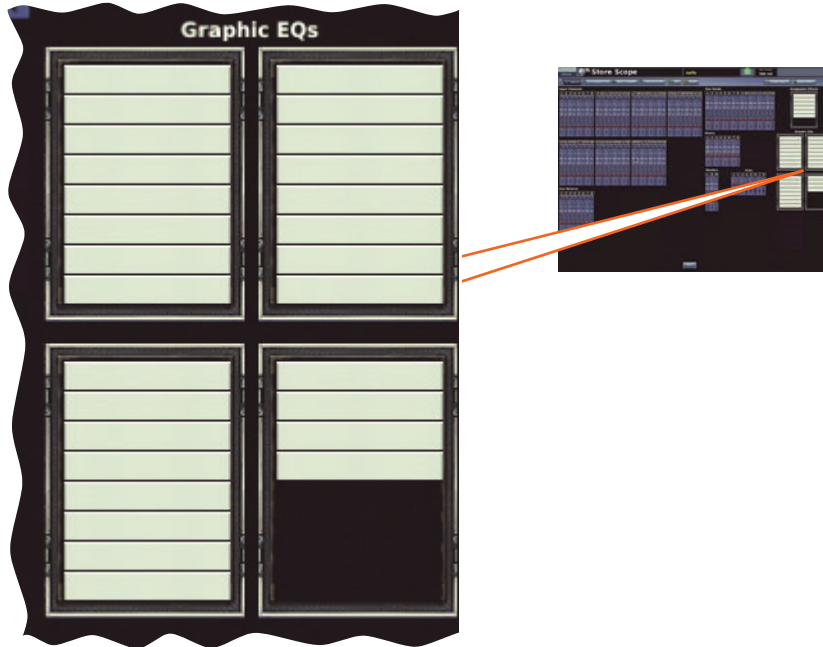







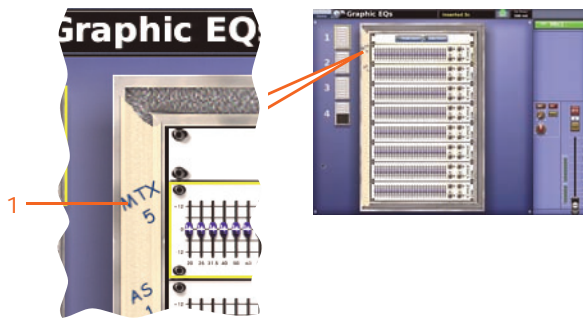

**Note:** A rack slot in the **Graphic EQs** section is equivalent to the **All**  scope area.

### Patching

The following diagram details the scoped patching parameters of the GEQs, which are shown on the **Graphic GEQs** screen (below).



		A	B	C	D	E	F	G	H
<b>Item</b>	<b>Parameter</b>								
<b>1</b>	Bus assignment/type	N/A	No	N/A	N/A	N/A	N/A	N/A	N/A

GEQ

The following diagram details the scoped parameters of the GEQs, and shows the GEQ window on the GUI screen.

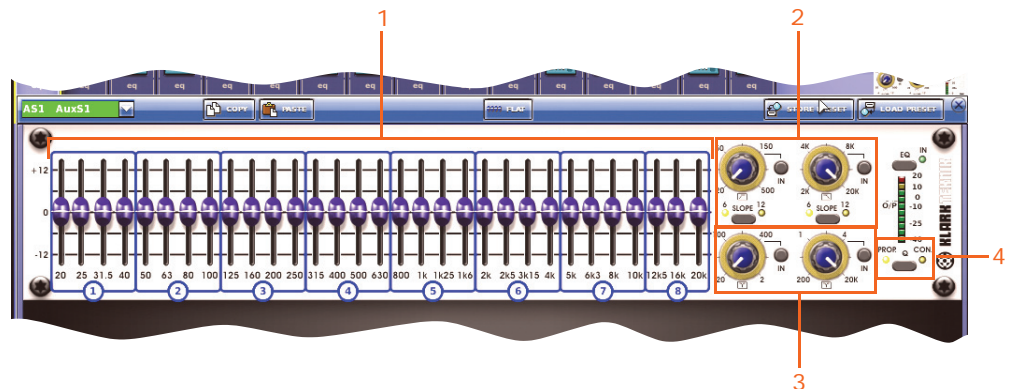

	A	B	C	D	E	F	G	H	
Item	Parameter								
1	EQ band gains	N/A	Yes	N/A	N/A	N/A	N/A	N/A	
2	HPF and LPF	N/A	Yes	N/A	N/A	N/A	N/A	N/A	
3	Notch filters	N/A	Yes	N/A	N/A	N/A	N/A	N/A	
4	GEQ mode (proportional/ constant Q)	N/A	Yes	N/A	N/A	N/A	N/A	N/A	

### Effects rack

Each scope screen has a rack of six effects in the **Assignable Effects** section.









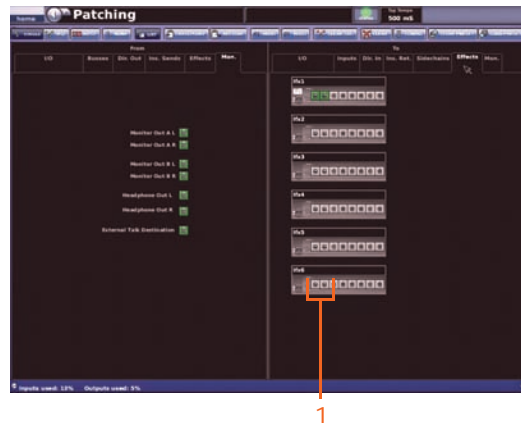

**Note:** A rack slot in the **Assignable Effects** section is equivalent to the **All**  scope area.

### Patching

The diagram right shows the scoped patching parameters of the effects, which are on the **Effects** tab of the **To** section of the **Patching** screen.



		A	B	C	D	E	F	G	H
<b>Item</b>	<b>Parameter</b>								
<b>1</b>	Input patching	N/A	No	N/A	N/A	N/A	N/A	N/A	N/A

Effects

This section details the scoped parameters of the effects, and shows a typical effect window on the GUI screen.



		A	B	C	D	E	F	G	H
<i>Item</i>	<i>Parameter</i>								
1	Effect name	N/A	Yes	N/A	N/A	N/A	N/A	N/A	N/A
2	Effect colour	N/A	Yes	N/A	N/A	N/A	N/A	N/A	N/A
3	Effect type	N/A	Yes	N/A	N/A	N/A	N/A	N/A	N/A
4	All effect parameters	N/A	Yes	N/A	N/A	N/A	N/A	N/A	N/A

## Groups

Each scope screen contains eight VCA channels in the **Variable Control Associates** section.



The following diagram shows the scoped parameters of the VCA group channels, and shows the **VCA Groups** screen on the GUI. This is a GUI only function.

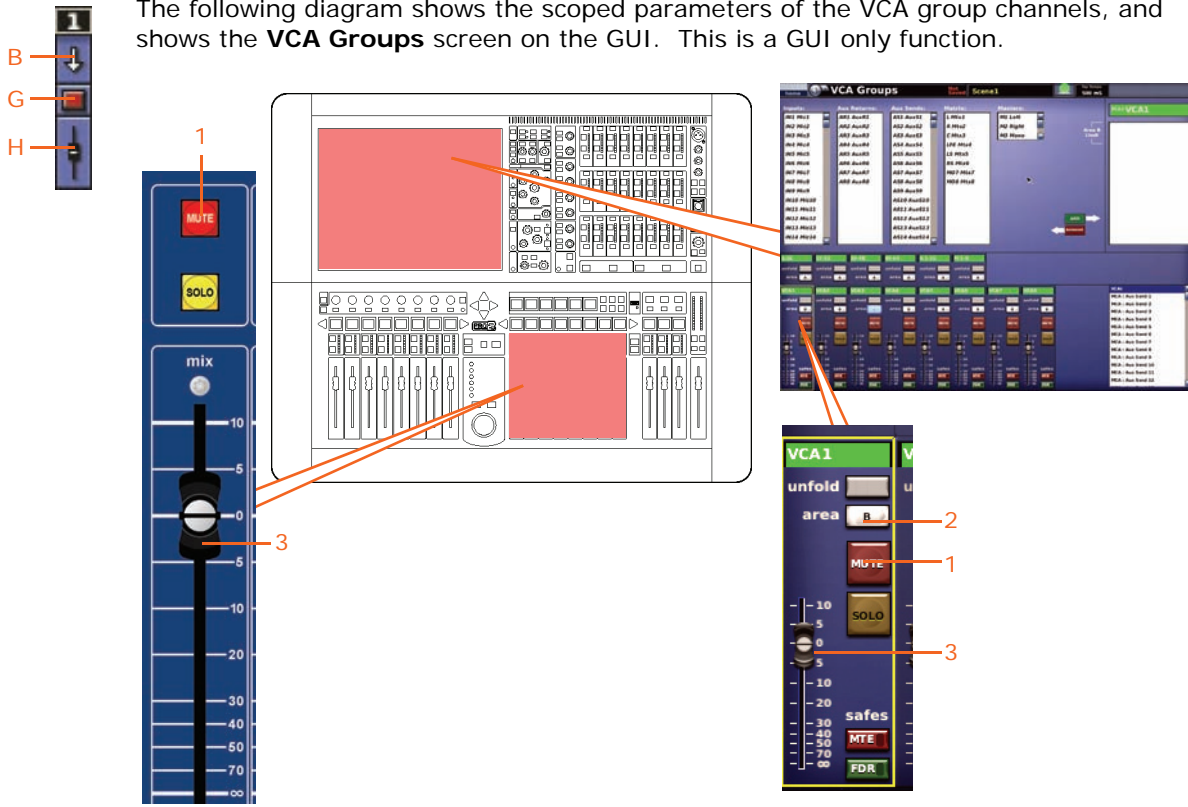

Item	Parameter	B	G	H
1	VCA mute	Yes	Yes	N/A
2	VCA area A/B	Yes	N/A	N/A
3	VCA fader level (required for surround panning)	Yes	N/A	Yes

## Appendix G: Parameters Affected By Automate Patching

This appendix shows the patching parameters (sources) that can be changed on a per-scene basis in automation. These are only selectable when the **Automate Patching** option of the **Preferences** scene is selected (see "Using patching in automation" on page 171).

### Inputs

The following input channel sources can be changed per scene.

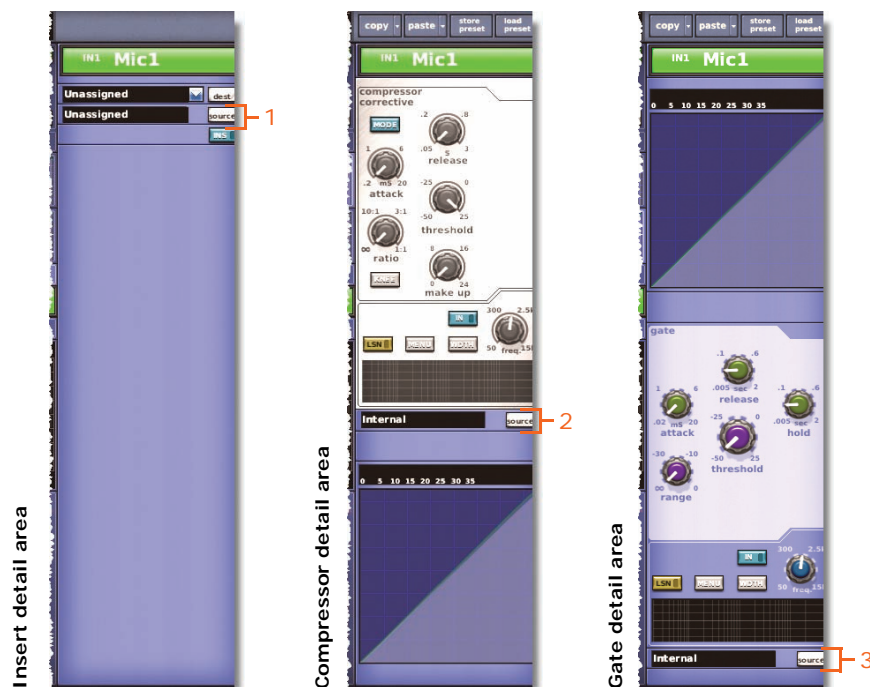

Item	Parameter
1	Insert return source
2	Compressor side chain source
3	Gate key source

Although the mic input and tape input sources are automatable, that is, they can be changed per scene, they are controlled by the input patching recall scope area switch (see Figure 30, "Parameter sections per input channel," on page 339). They are not affected by the **Automate Patching** function.

Input patching recall scope area switches





### Auxes

The source of each aux channel can be changed per scene.

Item	Parameter
1	Insert return source
2	Direct in source
3	Compressor side chain source



Configuration detail area



Compressor detail area

### Matrices

The destinations/sources of each matrix channel can be changed per scene.

Item	Parameter
1	Insert return source
2	Direct in source
3	Compressor side chain source



Configuration detail area



Compressor detail area



## Masters

The destinations/sources of each master channel can be changed per scene.

<i>Item</i>	<i>Parameter</i>
1	Insert return source
2	Direct in source
3	Compressor side chain source



Configuration detail area



Compressor detail area

## Effects

Effect input sources can be changed per scene. These are located on the **Effects** tab of the **To** section of the **Patching** screen (shown right).



## System devices

Sources for the outputs of external devices, such as the DL451 Modular I/O and DN9696 Recorder, etc., can be changed per scene. The sources are selectable via the **Stage I/O** and **FOH I/O** tabs in **To** section of the **Patching** screen (see Chapter 8 "Patching" on page 47). However, this does not include the I/O card configuration.

## Monitors

The following monitor sources can be changed per scene.

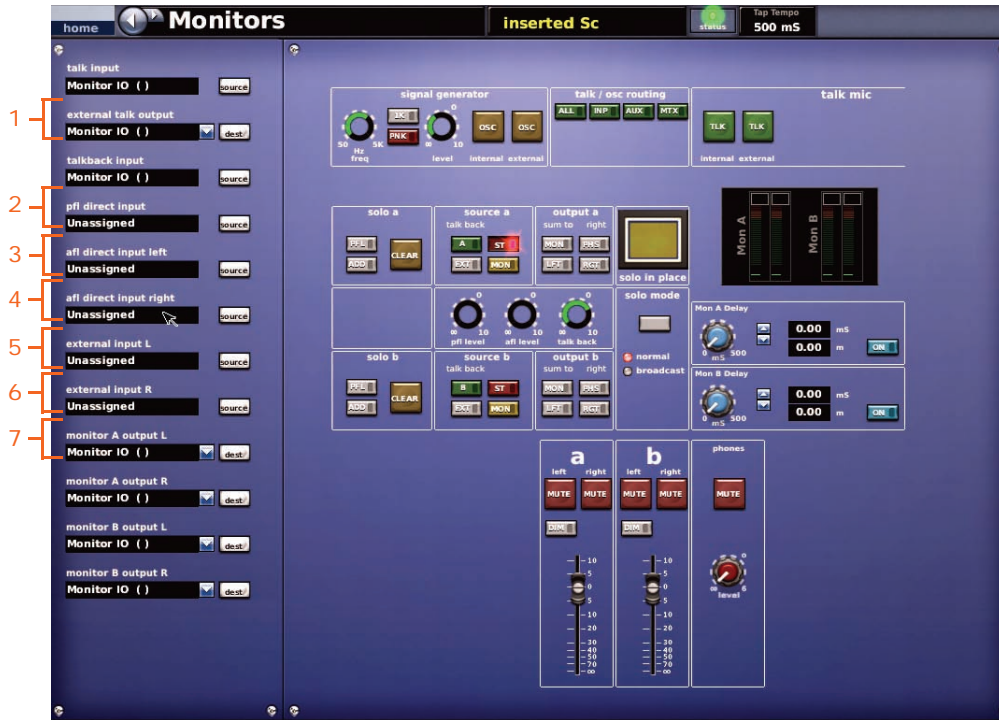

Item	Parameter
1	Talk input source
2	Taklback input source
3	PFL direct input source
4	AFL direct input left source
5	AFL direct input right source
6	External monitor input left source
7	External monitor input right source

## Appendix H: Parameters Protected By Safes

This appendix shows the parameters affected/unaffected by each of the safe types (**EQ**, **DYN**, **MIC**, **AUTO**, **MUTE** and **FADER**).

**Note:** The parameter areas for the scopes (store and recall) and the safes are, basically the same. However, the way they are presented in their respective appendices is different. This may provide you with a useful alternative when referring to this material, should you prefer one more than the other (see Appendix F "Parameters Affected By Scope" on page 337).

### Overview

The following table provides a quick reference for finding the channel/group safe areas in this appendix.

<b>Channel or Group</b>	<b>EQ safe</b>	<b>DYN safe</b>	<b>MIC safe</b>	<b>AUTO safe</b>	<b>MUTE safe</b>	<b>FADER safe</b>
<b>Input channel</b>	"EQ safe" on page 388	"DYN (dynamic) safe" on page 390	"MIC safe?" on page 392	"AUTO (automatio n) safe" on page 393	"MUTE safe" on page 394	"FADER safe" on page 395
<b>Aux</b>	"EQ safe" on page 399	"DYN (dynamic) safe" on page 401	"MIC safe" on page 402	"AUTO (automatio n) safe" on page 402	"MUTE safe" on page 403	"FADER safe" on page 404
<b>Return</b>	N/A	N/A	"MIC safe" on page 407	"AUTO (automatio n) safe" on page 408	"MUTE safe" on page 408	"FADER safe" on page 409
<b>Matrix</b>	"EQ safe" on page 413	"DYN (dynamic) safe" on page 415	"MIC safe" on page 416	"AUTO (automatio n) safe" on page 417	"MUTE safe" on page 417	"FADER safe" on page 418
<b>Master</b>	"EQ safe" on page 422	"DYN (dynamic) safe" on page 424	"MIC safe" on page 425	"AUTO (automatio n) safe" on page 425	"MUTE safe" on page 426	"FADER safe" on page 427
<b>VCA group</b>	N/A	N/A	N/A	"Automatio n safe" on page 429	"Mute (MTE) safe" on page 430	"Fader (FDR) safe" on page 430

## Inputs

The input safes are selected via the **input channel safes** section of the input channel strip in each input bay (control surface) or the configuration detail area of the GUI channel strip.

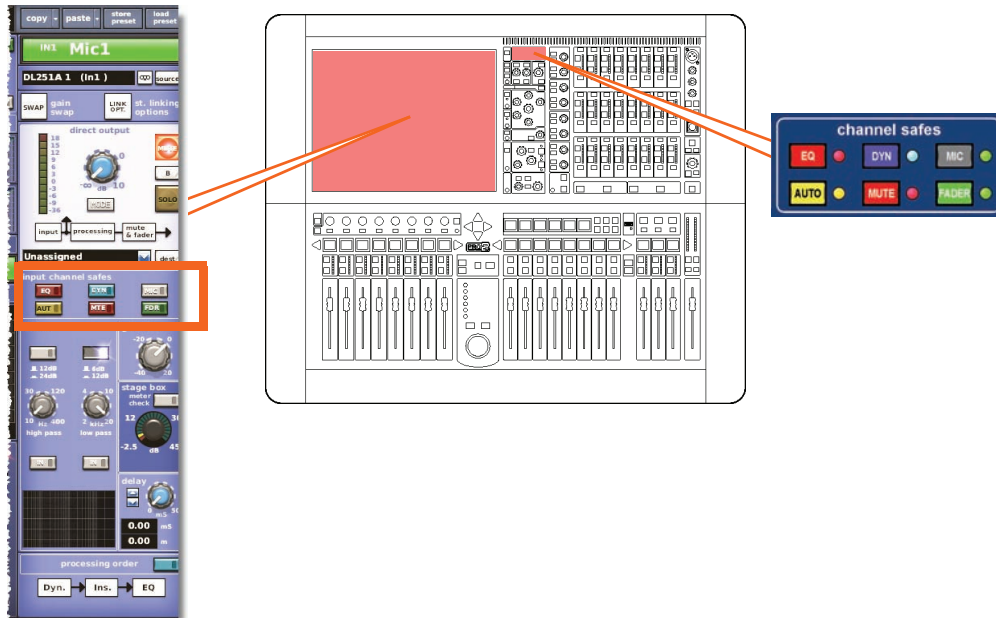

**Input parameters not affected by the safes**

The following input channel parameters are *not* affected by any of the safes.

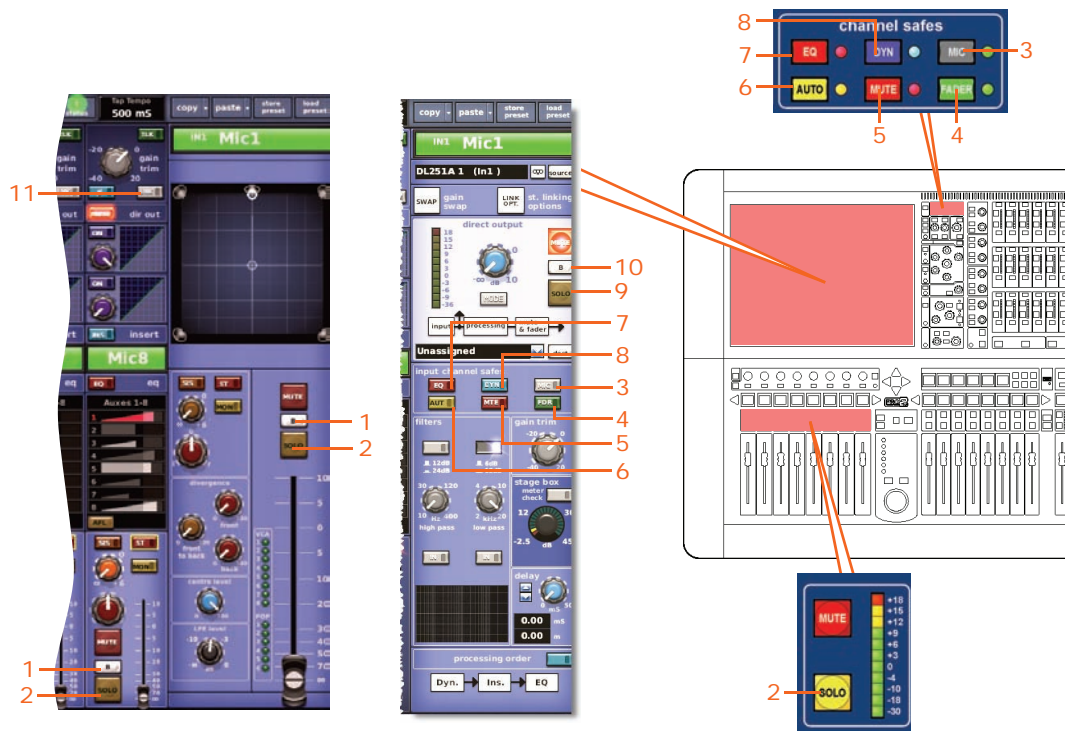

Item	Control	Parameter
1	SOLO B/[B] switch	Solo B on/off
2	SOLO switch	Solo on/off
3	MIC switch	Mic safe on/off
4	FADER/[FDR] switch	Fader safe on/off
5	MUTE/[MTE] switch	Mute safe on/off
6	AUTO/[AUT] switch	Automation safe on/off
7	EQ switch	EQ safe on/off
8	DYN switch	Dynamic safe on/off
9	SOLO switch	Direct output solo on/off
10	SOLO B/[B] switch	Direct output solo B on/off
11	LINK switch	Stereo linking on/off

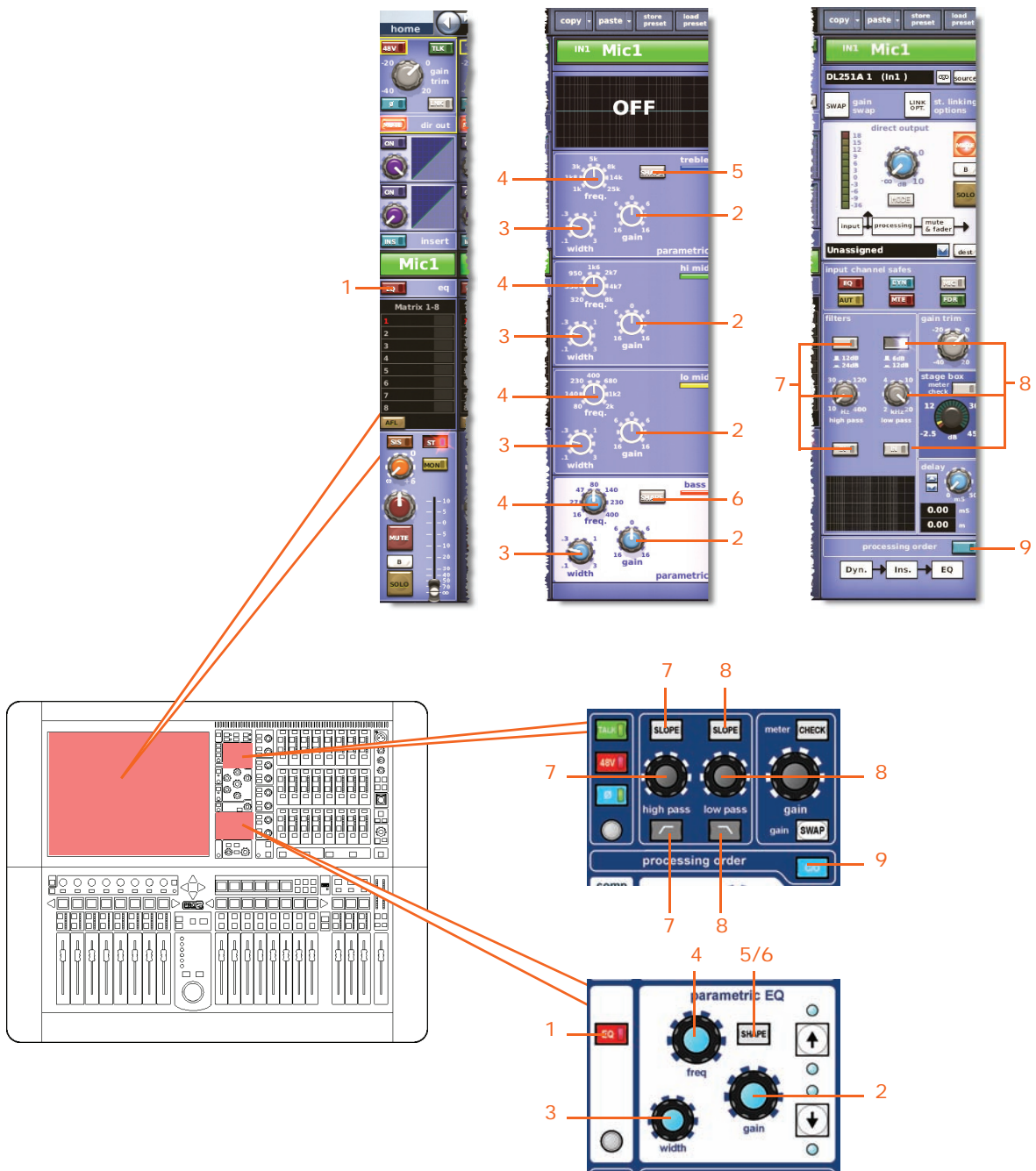

EQ safe

The following diagram details the parameters in the inputs affected by the **EQ** safe, and shows the EQ detail area in the GUI channel strip.



Item	Control(s)	Parameter
1	EQ switch	EQ on/off
2	gain control knob	EQ gain level
3	width control knob	EQ width
4	freq control knob	EQ frequency

---

<i>Item</i>	<i>Control(s)</i>	<i>Parameter</i>
5	<b>SHAPE</b> switch	Selects treble shelving mode: parametric, bright, classic or soft
6	<b>SHAPE</b> switch	Selects bass shelving mode: parametric, deep, classic or warm
7	<b>SLOPE</b> switch, <b>high pass</b> control knob,  /[IN] switch	High pass filter
8	<b>SLOPE</b> switch, <b>low pass</b> control knob,  /[IN] switch	Low pass filter
9	<b>C/O</b> switch	Order of processing: <b>Dyn.</b> → <b>Ins.</b> → <b>EQ</b> or <b>EQ</b> → <b>Ins.</b> → <b>Dyn.</b>

---



**DYN (dynamic) safe**

The following diagram details the parameters in the inputs protected by **DYN** safe.

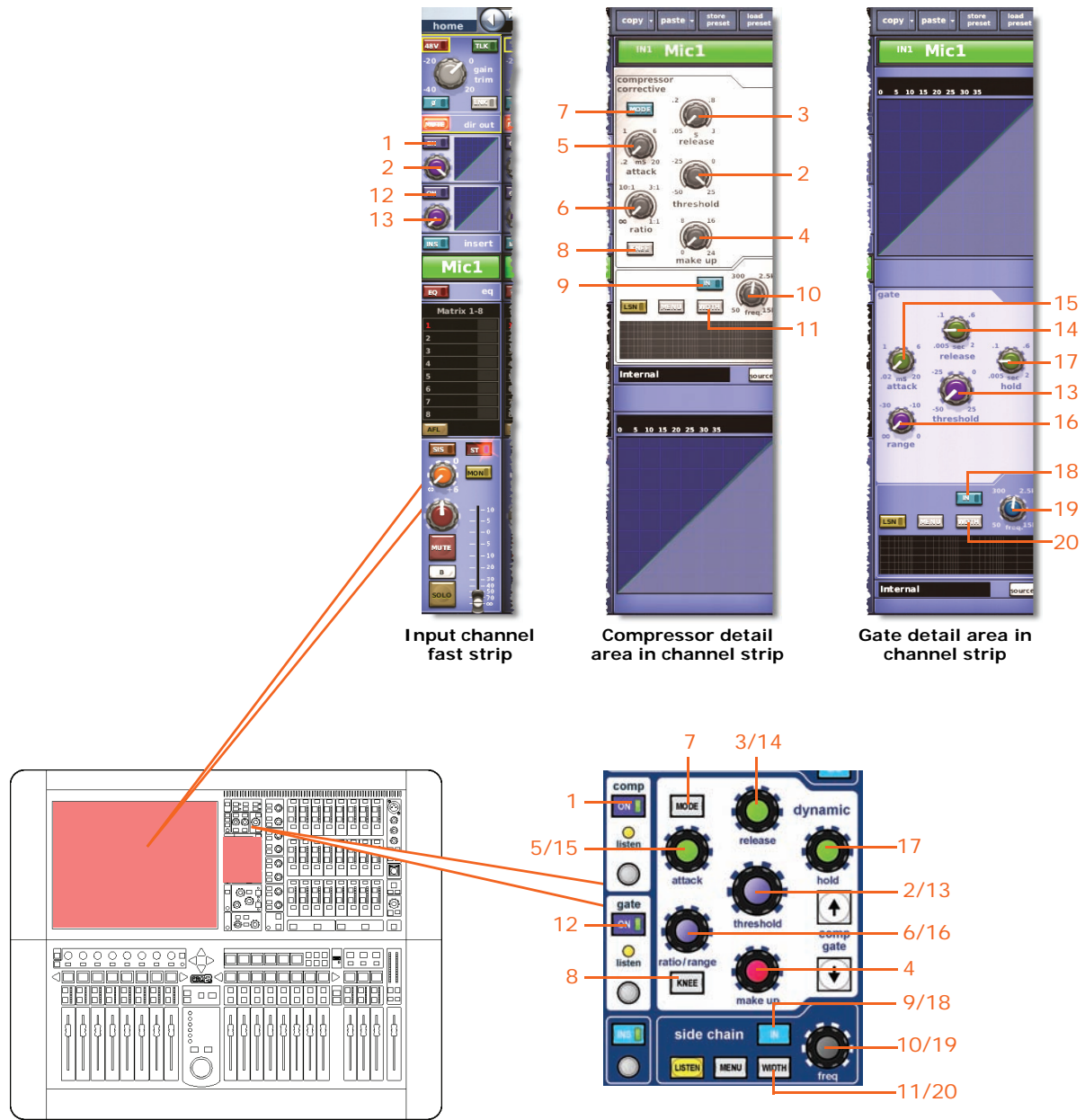

**Note:** Only the corrective compressor is shown above, but this is typically the same for the other compressor modes (adaptive, creative and vintage).

Item	Control	Parameter
1	ON switch	Compressor on/off
2	threshold control knob	Compressor threshold
3	release control knob	Compressor release



<i>Item</i>	<i>Control</i>	<i>Parameter</i>
4	<b>gain/[make up]</b> control knob	Compressor make up gain
5	<b>attack</b> control knob?	Compressor attack
6	<b>ratio/range/[ratio]</b> control knob	Compressor ratio
7	<b>MODE</b> pushbutton	Compressor mode: corrective (shown above), adaptive, creative or vintage
8	<b>KNEE</b> pushbutton	Compressor knee: hard, medium or soft
9	<b>IN</b> switch	Compressor sidechain in/out
10	<b>freq</b> control knob	Compressor sidechain frequency
11	<b>WIDTH</b> pushbutton	Compressor sidechain width: 2 Oct, 1 Oct or 0.3 Oct
12	<b>ON</b> switch	Gate on/off
13	<b>threshold</b> control knob	Gate threshold
14	<b>release</b> control knob	Gate release
15	<b>attack</b> control knob	Gate attack
16	<b>ratio/range/[range]</b> control knob	Gate range
17	<b>hold</b> control knob	Gate hold
18	<b>IN</b> switch	Gate sidechain in/out
19	<b>freq</b> control knob	Gate sidechain frequency
20	<b>WIDTH</b> pushbutton	Gate sidechain width: 2 Oct, 1 Oct or 0.3 Oct



<i>Item</i>	<i>Control</i>	<i>Parameter</i>
1	<b>stage box</b> control knob*	Gain of remote amplifier
2	<b>48V</b> switch	48V phantom gain
3	<b>30Hz</b> switch	30Hz filter
4	<b>gain trim</b> control knob*	Digital input trim
5	Delay control knob	Delay time
6	<b>Ø</b> switch	Input phase invert on/off
7	Level control knob	Direct output level
8	<b>MODE</b> switch	Direct output tap-off point: "Post-fade and mute", "Pre-mute, pre-processing" or "Pre-mute, post-processing"
9	<b>dest</b> button, text field	Direct output tap-off point
10	<b>INS</b> switch	Insert in/out

\* Depends on swap status.

#### **AUTO (automation) safe**

All of the input channel parameters are protected by the **AUTO** safe — except, of course, for the ones unaffected by the safes (see "Input parameters not affected by the safes" on page 387).

**MUTE safe**

The following diagram details the parameters in the inputs protected by **MUTE** safe, and shows the master routing detail area in the GUI channel strip.

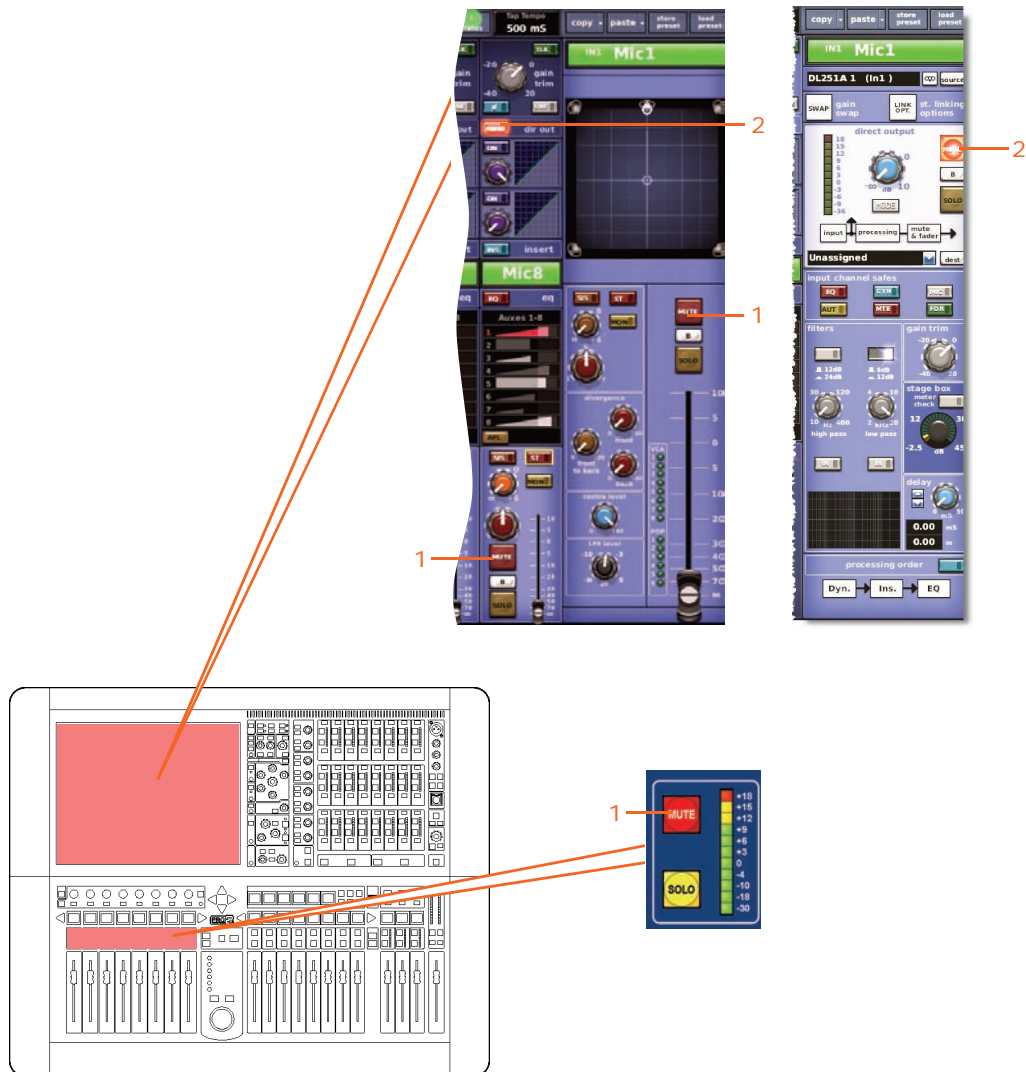

<i>Item</i>	<i>Control</i>	<i>Parameter</i>
<b>1</b>	<b>MUTE</b> switch	Mute on/off
<b>2</b>	<b>MUTE</b> switch	Direct output mute on/off

**FADER safe**

The following diagram details the parameters in the inputs protected by **FADER safe**, and shows the master routing detail area in the GUI channel strip.

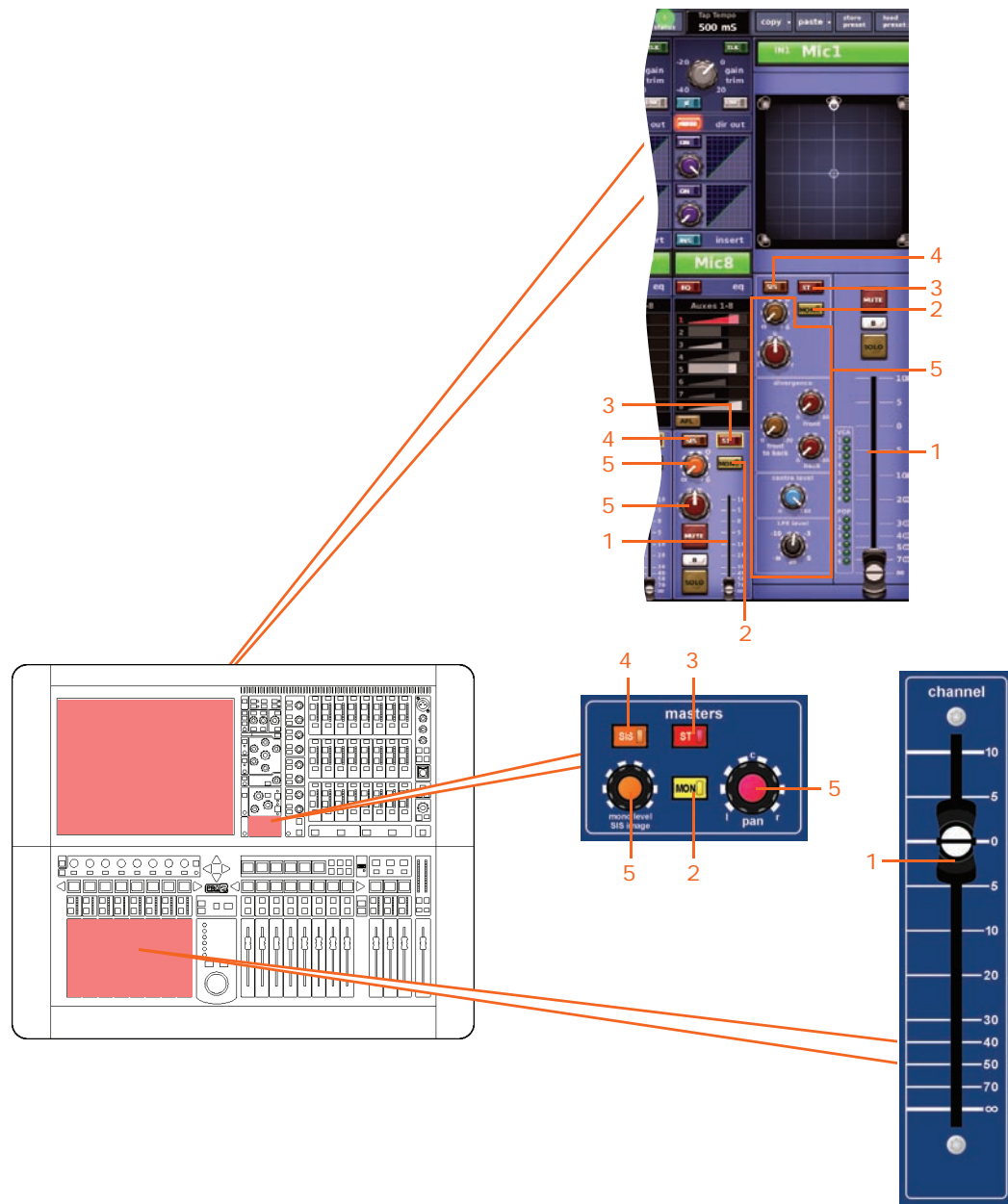

<i>Item</i>	<i>Control(s)</i>	<i>Parameter</i>
<b>1</b>	Fader	Fader level
<b>2</b>	<b>MON</b> switch	Mono routing on/off
<b>3</b>	<b>ST</b> switch	Stereo routing on/off
<b>4</b>	<b>SIS</b> switch	Spatial imaging system on/off
<b>5</b>	Panning control knobs	Surround panning (includes all surround sound parameters)

## Auxes (Aux Sends)

The aux safes are selected via the **output channel safes** section of the output channel strip in the mix bay (control surface) and the configuration detail area of the GUI channel strip.

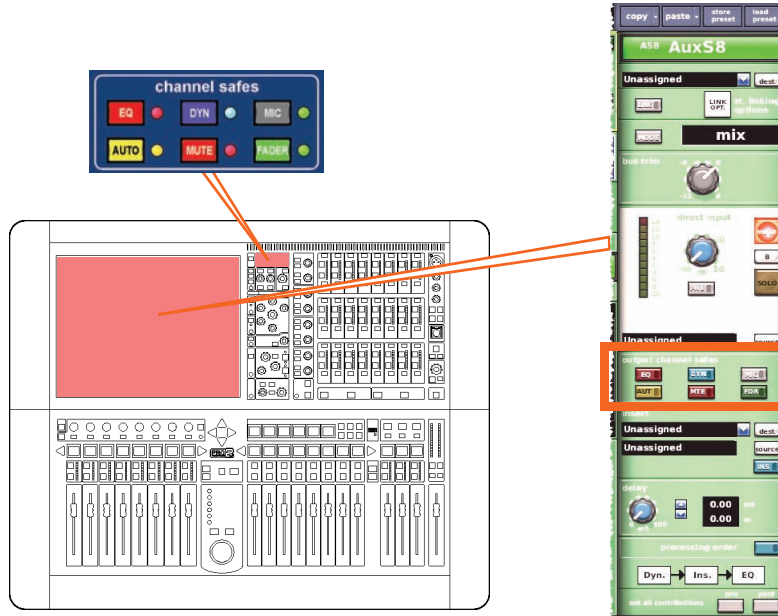

Aux parameters not affected by the safes

The following shows you which parameters are *not* affected by each safe.

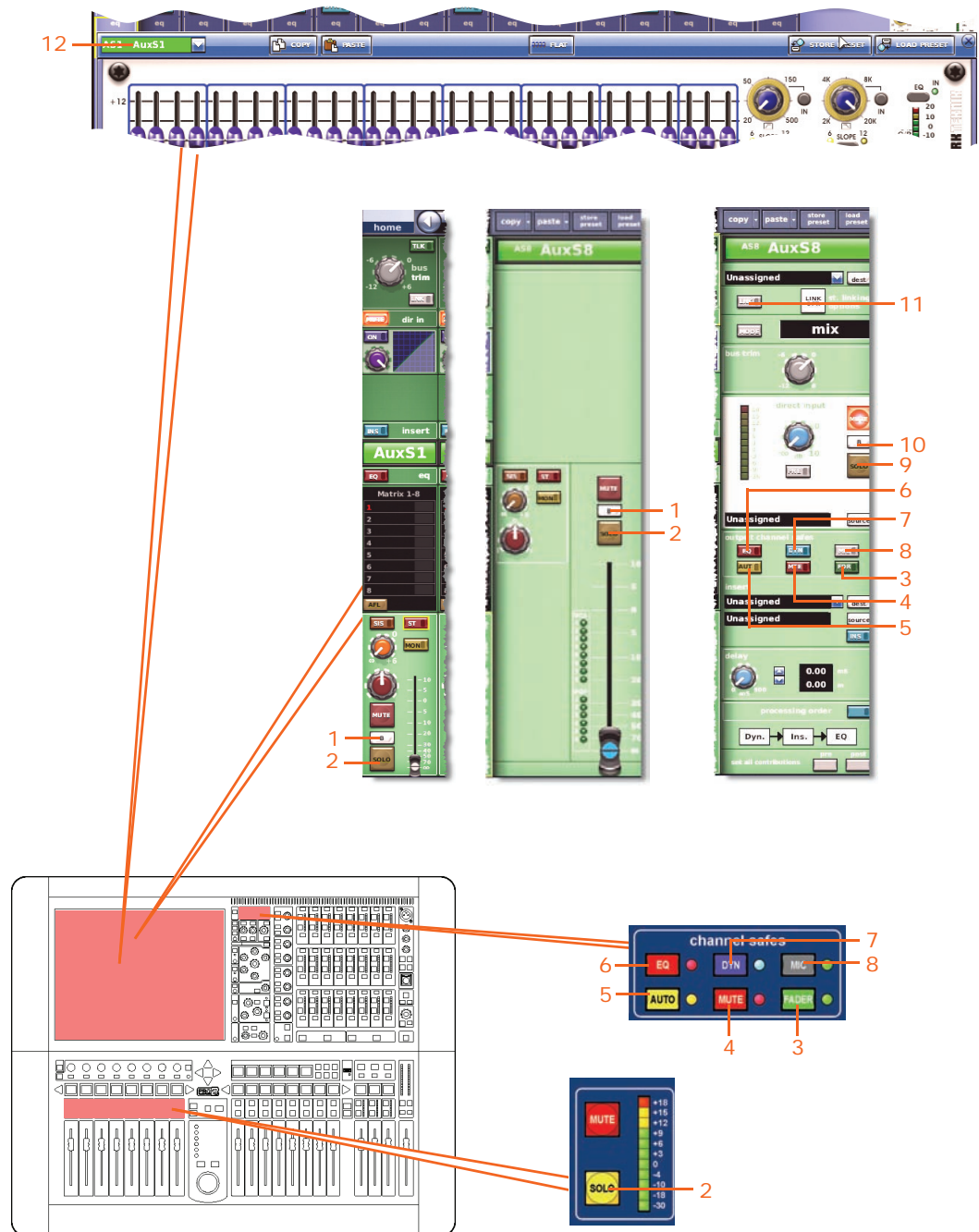

<i>Item</i>	<i>Control</i>	<i>Parameter</i>
1	<b>SOLO B/[B]</b> switch	Solo B on/off
2	<b>SOLO</b> switch	Solo on/off
3	<b>FADER/[FDR]</b> switch	Fader safe on/off
4	<b>MUTE/[MTE]</b> switch	Mute safe on/off
5	<b>AUTO/[AUT]</b> switch	Automation safe on/off
6	<b>EQ</b> switch	EQ safe on/off
7	<b>DYN</b> switch	Dynamic safe on/off
8	<b>MIC</b> switch	Mic safe on/off
9	<b>SOLO</b> switch	Direct input solo on/off
10	<b>SOLO B/[B]</b> switch	Direct input solo B on/off
11	<b>LINK</b> switch	Stereo linking on/off
12	Field	GEQ assignment



EQ safe

The following diagram details the parameters in the auxes protected by the **EQ** safe, and shows the EQ detail area in the GUI channel strip and the GEQ window on the GUI screen.

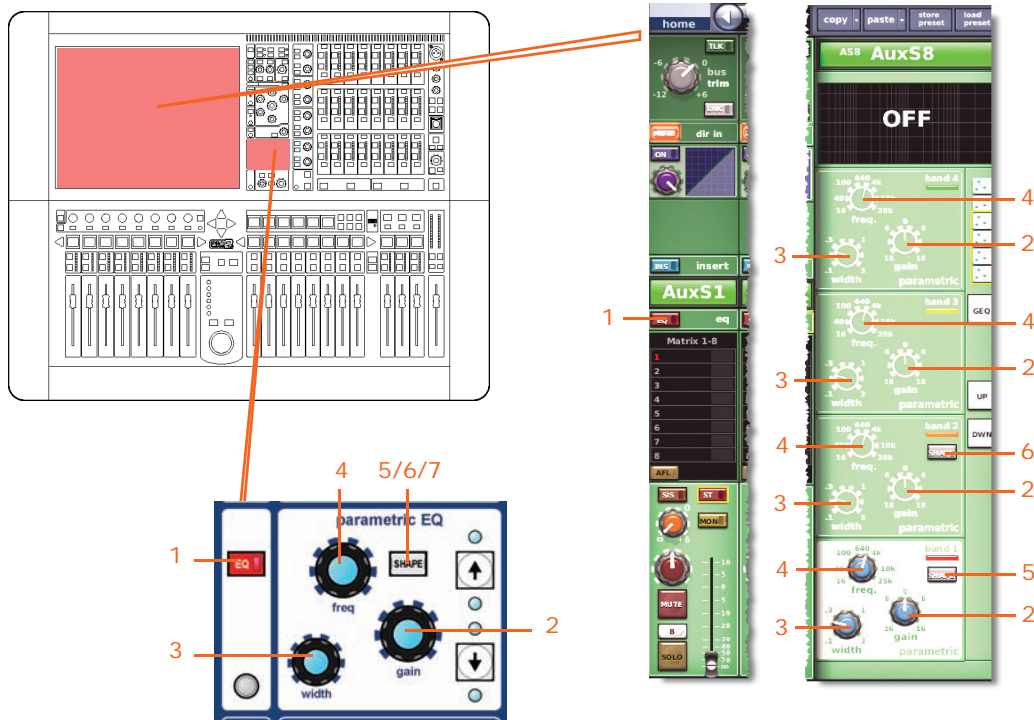

Item	Control	Parameter
1	EQ switch	EQ on/off
2	gain control knob	EQ gain level
3	width control knob	EQ width
4	freq control knob	EQ frequency
5	SHAPE switch	Band 1 shelving mode: parametric, warm, high pass 6dB or high pass 12dB
6	SHAPE switch	Band 2 shelving mode: parametric or high pass 24dB
7*	SHAPE switch	Band 6 shelving mode: parametric, soft, low pass 6dB or low pass 12dB

\* Not shown in diagram.

**Note:** Although bands 5 and 6 are not shown above, the items in the table also apply. Both bands have items 2, 3 and 4, and band 6 also has item 7.

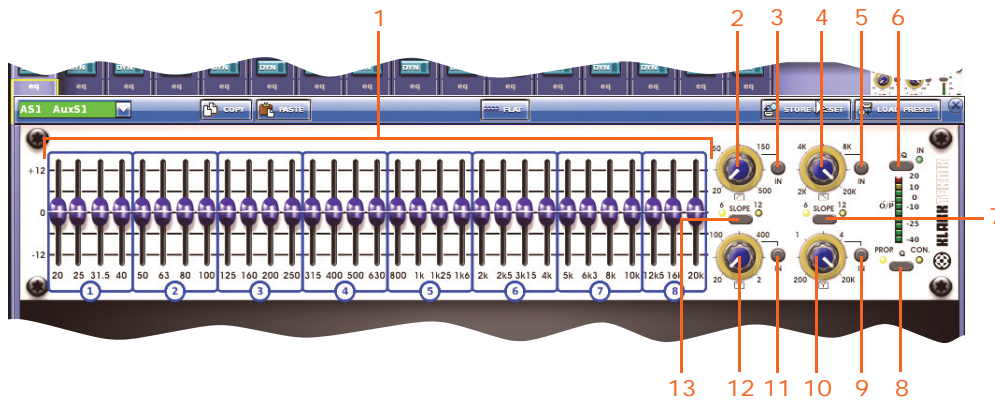

<i>Item</i>	<i>Control</i>	<i>Parameter</i>
1	31 faders	Fader positions
2	High pass filter control knob	High pass filter cut off frequency
3	<b>IN</b> switch	High pass filter in/out
4	Low pass filter control knob	Low pass filter cut off frequency
5	<b>IN</b> switch	Low pass filter in/out
6	<b>EQ</b> switch	EQ in/out
7	<b>SLOPE</b> switch	Selects low pass filter as 6dB or 12dB
8	<b>Q</b> switch	Selects Q mode as proportional ( <b>PROP.</b> ) or constant ( <b>CON.</b> )
9	<b>IN</b> switch	Switches 200Hz - 20kHz notch filter in/out
10	Notch filter control knob	200Hz - 20kHz notch filter frequency
11	<b>IN</b> switch	Switches 20Hz - 2kHz notch filter in/out
12	Notch filter control knob	20Hz - 2kHz notch filter frequency
13	<b>SLOPE</b> switch	Selects high pass filter as 6dB or 12dB

**DYN (dynamic) safe**

The following diagram details the parameters in the auxes protected by the **DYN** safe, and shows the compressor detail area in the GUI channel strip. Only the corrective compressor is shown, but this is typically the same for the other compressor modes (adaptive, creative, vintage and shimmer).

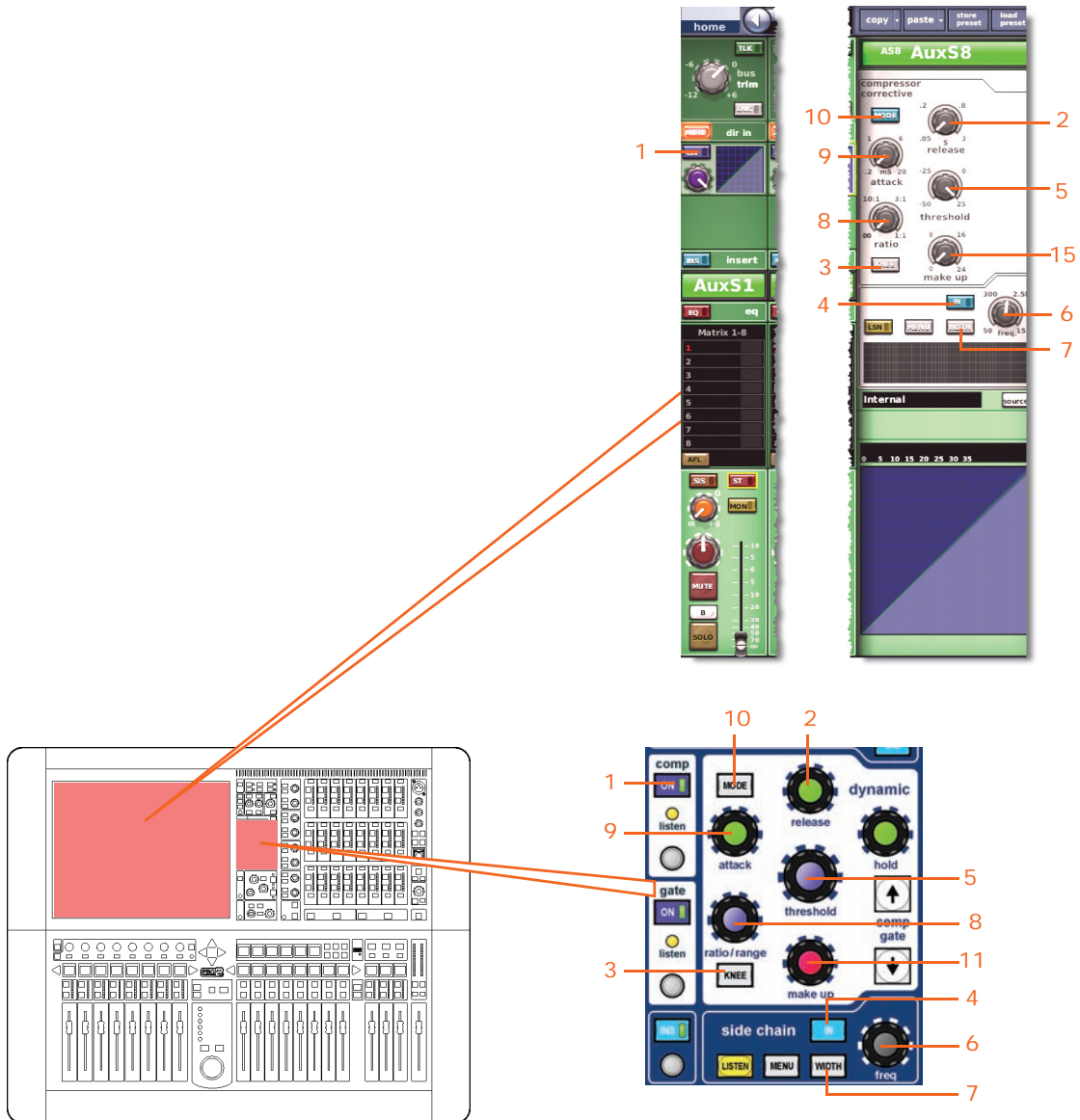

Item	Control	Parameter
1	<b>ON</b> switch	Compressor on/off
2	<b>release</b> control knob	Compressor release
3	<b>KNEE</b> pushbutton	Compressor knee selector: hard, medium and soft
4	<b>IN</b> switch	Compressor sidechain in/out
5	<b>threshold</b> control knob	Compressor threshold
6	<b>freq</b> control knob	Compressor sidechain frequency

<i>Item</i>	<i>Control</i>	<i>Parameter</i>
7	<b>WIDTH</b> pushbutton	Compressor sidechain width (unlabelled): 2 Oct, 1 Oct or 0.3 Oct
8	<b>ratio</b> control knob	Compressor ratio
9	<b>attack</b> control knob	Compressor attack
10	<b>MODE</b> pushbutton	Compressor mode — corrective, adaptive, creative, vintage or shimmer
11	<b>make up</b> control knob	Compressor gain

**MIC safe**

The following diagram details the parameters in the auxes protected by **MIC** safe, and shows the configuration detail area in the GUI channel strip.

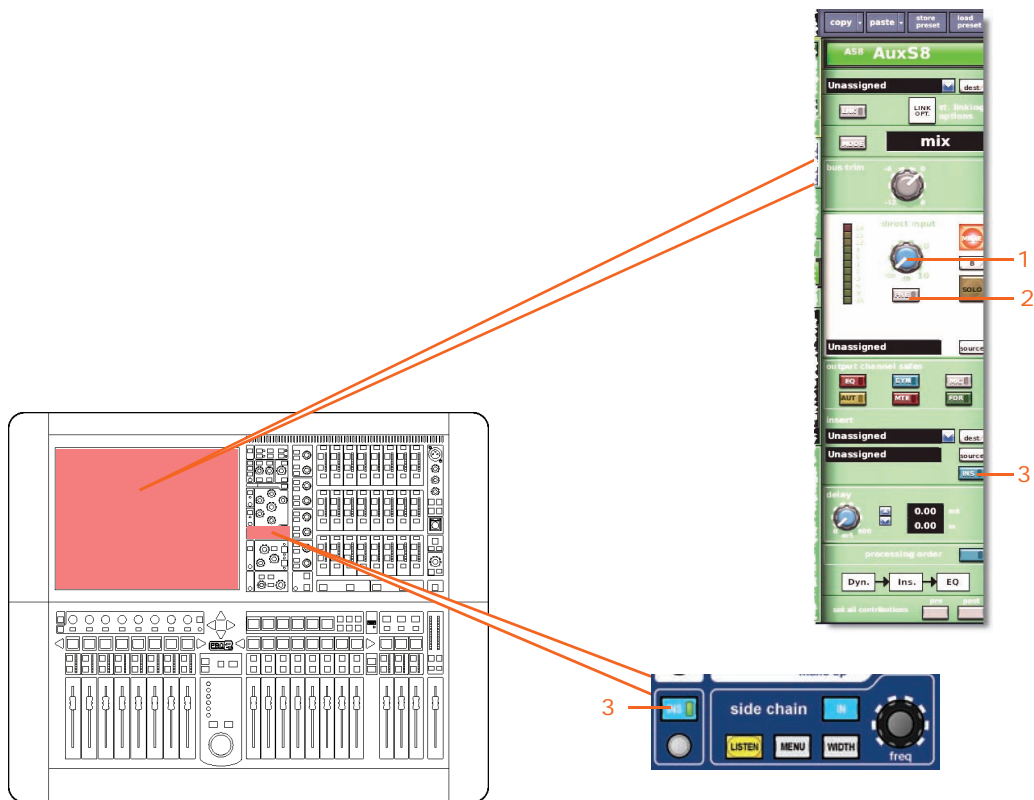

<i>Item</i>	<i>Control</i>	<i>Parameter</i>
1	<b>level</b> control knob	Direct input level
2	<b>MODE/[PRE]</b> switch	Direct input pre- in/out
3	<b>INS</b> switch	Insert in/out

**AUTO (automation) safe**

All of the aux channel parameters are protected by the **AUTO** (automation) safe — except, of course, for the ones unaffected by the safes (see “Aux parameters not affected by the safes” on page 397).

**MUTE safe**

The following diagram details the parameters of the auxes protected by **MUTE** safe, and shows the master routing detail area in the GUI channel strip.

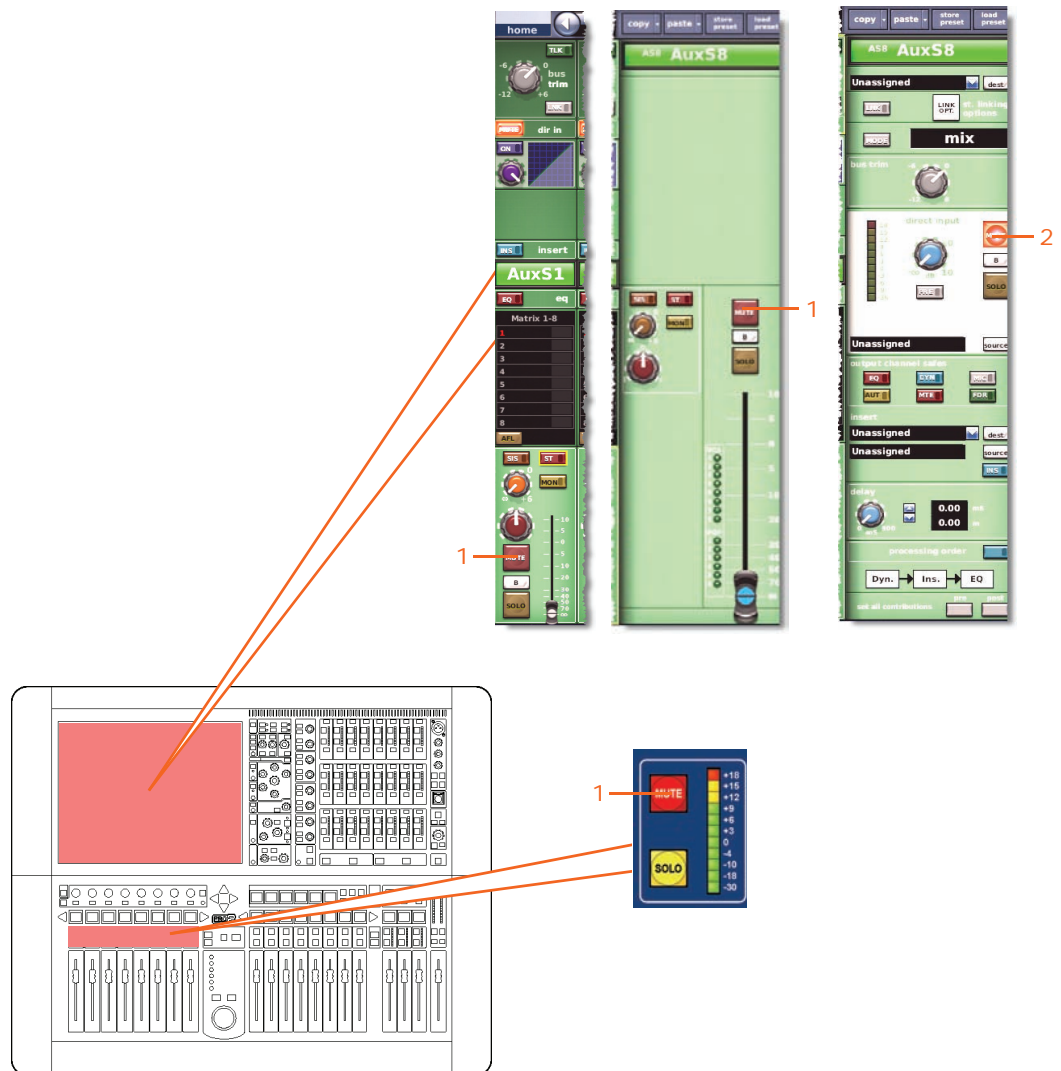

<i>Item</i>	<i>Control</i>	<i>Parameter</i>
1	<b>MUTE</b> switch	Mute on/off
2	<b>MUTE</b> switch	Direct input mute on/off

FADER safe

The following diagram details the parameters of the auxes protected by **FADER** safe, and shows the configuration detail area and master routing detail area???????? in the GUI channel strip.

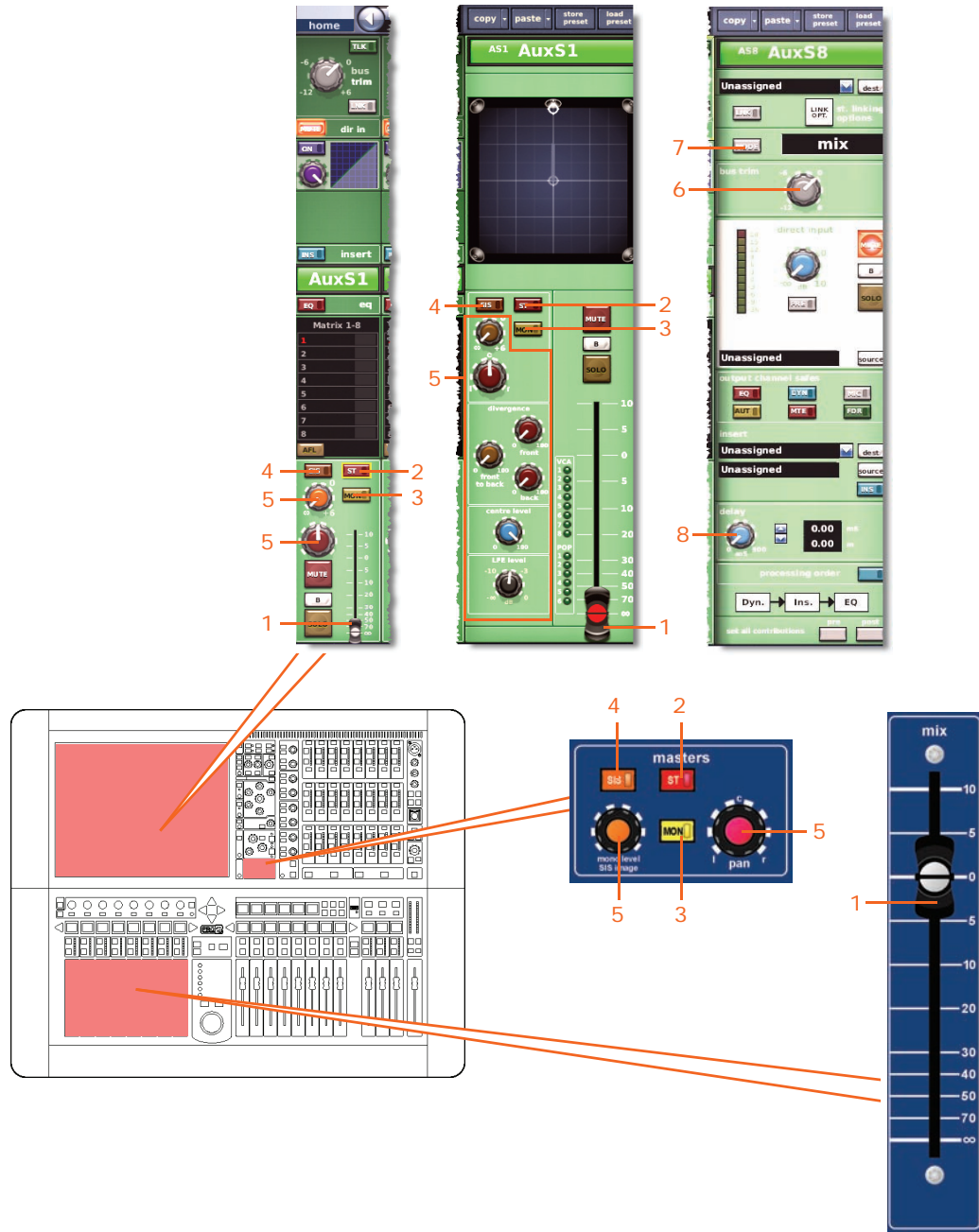

<i>Item</i>	<i>Control</i>	<i>Parameter</i>
1	Fader	Fader level
2	<b>ST</b> switch	Stereo routing
3	<b>MON</b> switch	Mono routing
4	<b>SIS</b> switch	Spatial imaging system in/out
5	Panning control knobs	Surround sound panning (includes all surround parameters)
6	<b>bus trim</b> control knob	Bus trim level
7	<b>MODE</b> switch	Bus mode
8	<b>delay</b> control knob	Delay time

## Returns (Aux Returns)

The return safes are selected via the **output channel safes** section of the output channel strip in the mix bay (control surface) and the configuration detail area of the GUI channel strip.

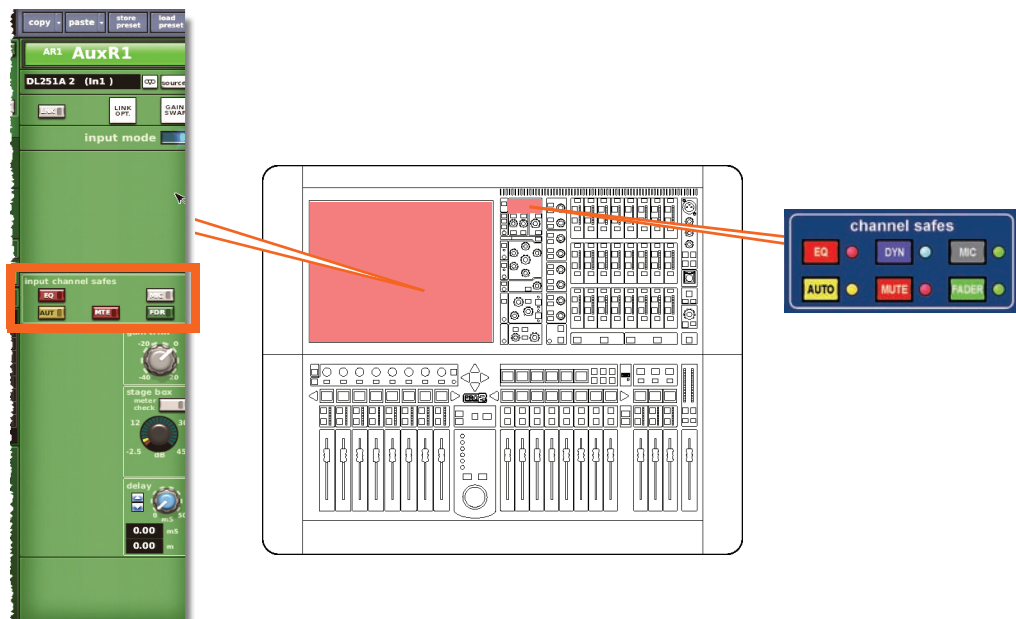



**Return parameters not affected by the safes**

The following shows you which parameters are *not* affected by each safe.

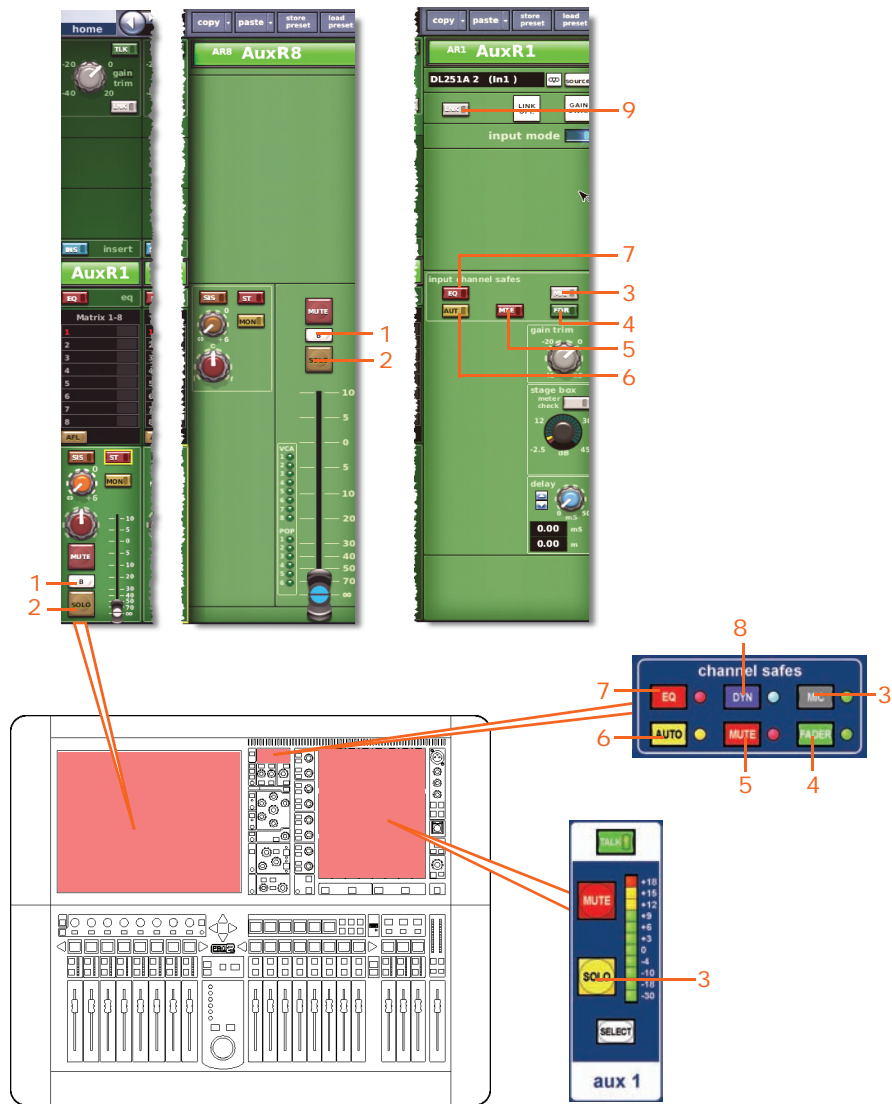

Item	Control	Parameter
1	SOLO B/[B] switch	Solo B on/off
2	SOLO switch	Solo on/off
3	MIC switch	Mic safe on/off
4	FADER/[FDR] switch	Fader safe on/off
5	MUTE/[MTE] switch	Mute safe on/off
6	AUTO/[AUT] switch	Automation safe on/off
7	EQ switch	EQ safe on/off
8	DYN switch	Dynamic safe on/off
9	LINK switch	Stereo linking on/off



**EQ safe**

Not applicable.

**DYN (dynamic) safe**

Not applicable.

**MIC safe**

The following diagram details the parameters in the returns protected by **MIC** safe, which are accessible via the DL431 Mic Splitter configuration (see “Configuring the devices” on page 60).

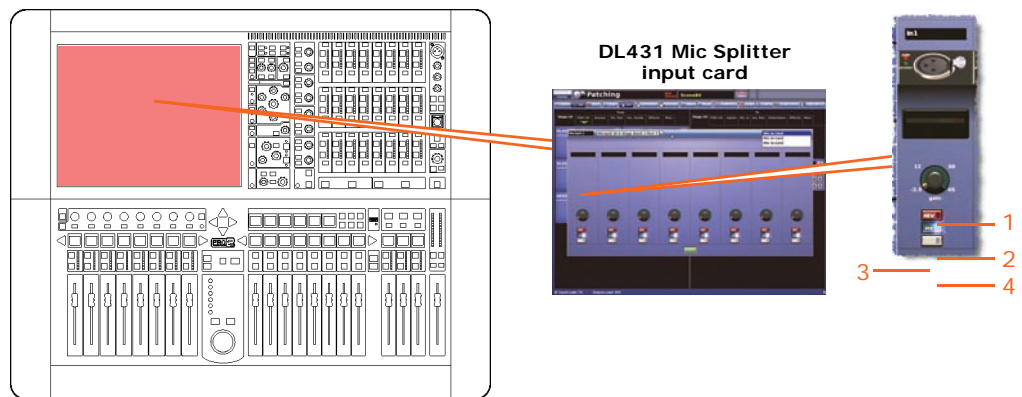

<i>Item</i>	<i>Control</i>	<i>Parameter</i>
1	Stage box control knob	Mic gain
2	<b>48V</b> switch	48V phantom gain in/out
3	<b>Flt</b> switch	30Hz filter <sup>1</sup> in/out
4	Input zone switch	Input zone in/out

1. Applies to tape and primary inputs.

**AUTO (automation) safe**

All of the return channel parameters are protected by **AUTO** (automation) safe — except, of course, for the ones unaffected by the safes (see “Return parameters not affected by the safes” on page 406).

**MUTE safe**

The following diagram details the parameters of the returns protected by **MUTE** safe, and shows the master routing detail area in the GUI channel strip.

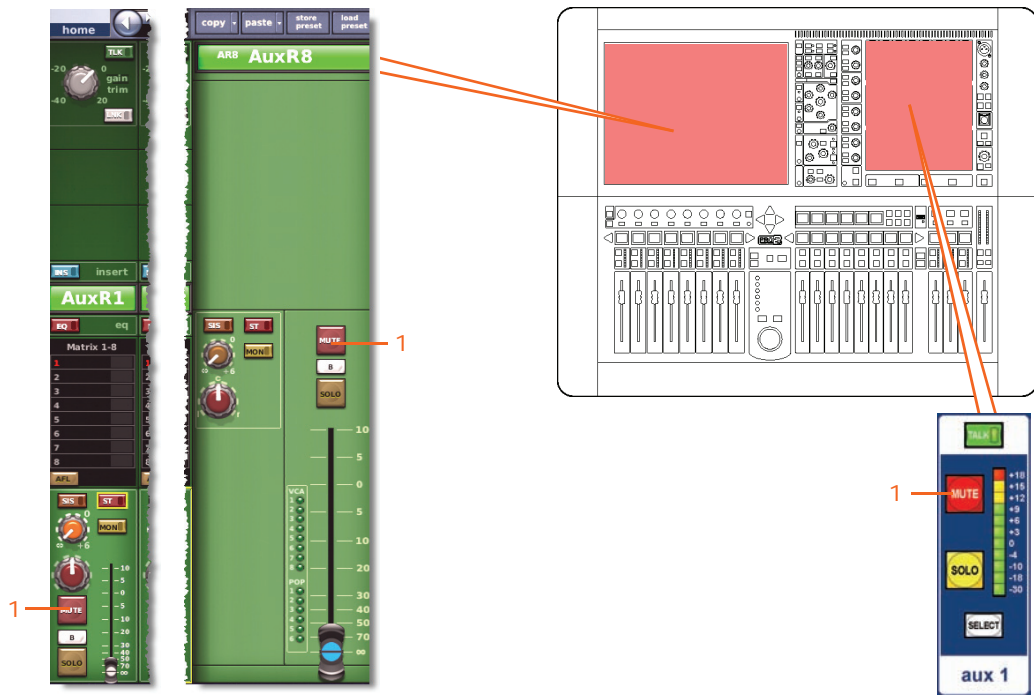

<i>Item</i>	<i>Control</i>	<i>Parameter</i>
1	MUTE switch	Mute on/off

## FADER safe

The following diagram details the parameters of the returns protected by **FADER** safe, and shows the master routing detail area in the GUI channel strip.

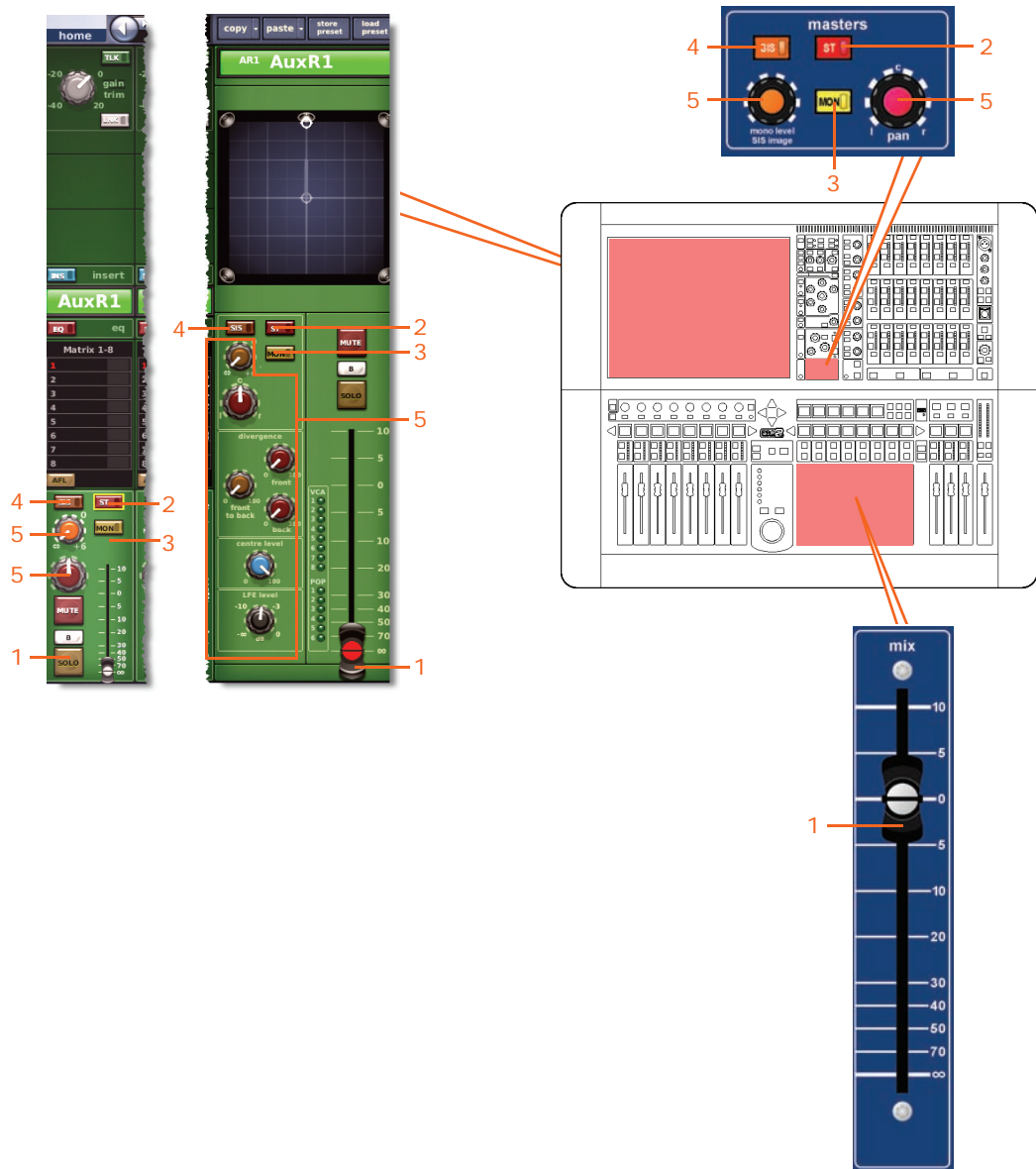

Item	Control	Parameter
1	Fader	Fader level
2	<b>ST</b> switch	Stereo routing
3	<b>MON</b> switch	Mono routing
4	<b>SIS</b> switch	Spatial imaging system in/out
5	Panning control knobs	Surround panning (includes all surround sound parameters)

### Matrices

The matrix safes are selected via the **output channel safes** section of the output channel strip in the mix bay (control surface) and the configuration detail area of the GUI channel strip.

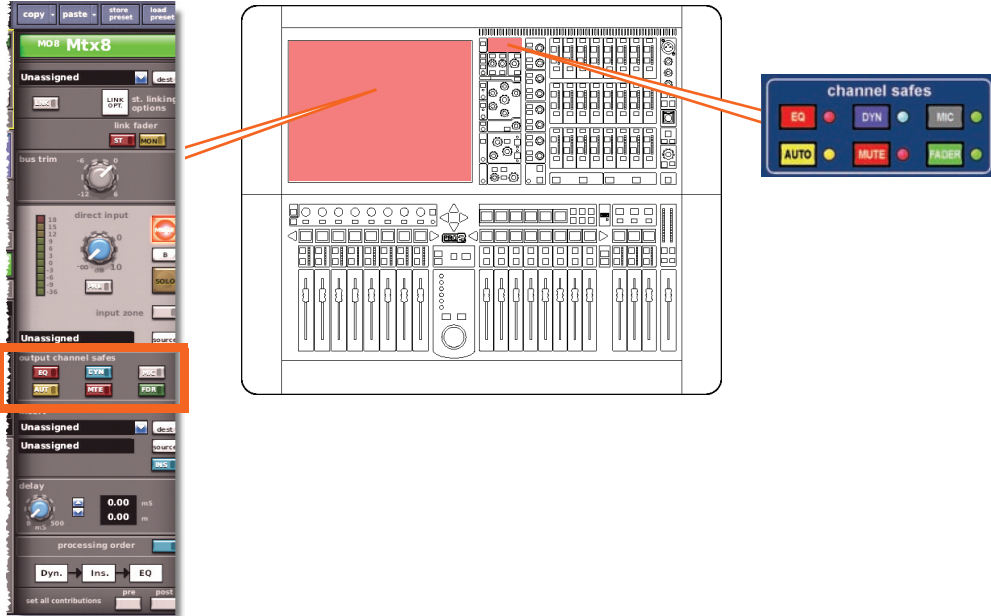

**Matrix parameters not affected by the safes**

The following shows you which parameters are *not* affected by each safe.

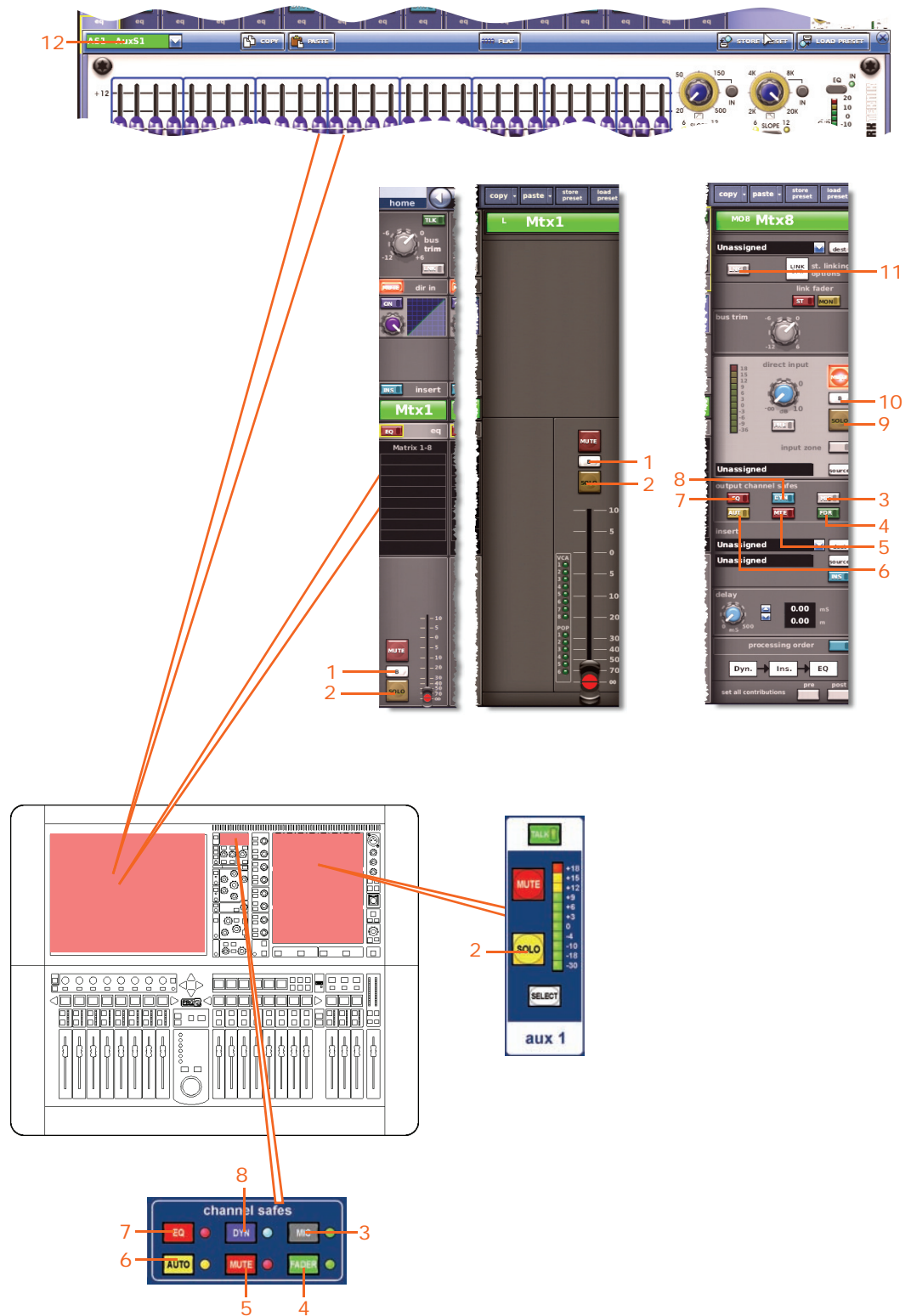

<i>Item</i>	<i>Control</i>	<i>Parameter</i>
1	<b>SOLO B/[B]</b> switch	Solo B on/off
2	<b>SOLO</b> switch	Solo on/off
3	<b>MIC</b> switch	Mic safe on/off
4	<b>FADER/[FDR]</b> switch	Fader safe on/off
5	<b>MUTE/[MTE]</b> switch	Mute safe on/off
6	<b>AUTO/[AUT]</b> switch	Automation safe on/off
7	<b>EQ</b> switch	EQ safe on/off
8	<b>DYN</b> switch	Dynamic safe on/off
9	<b>SOLO</b> switch	Direct input solo on/off
10	<b>SOLO B/[B]</b> switch	Direct input solo B on/off
11	<b>LINK</b> switch	Stereo linking on/off
12	Field	GEQ assignment

EQ safe

The following diagram details the parameters in the matrices protected by the **EQ** safe, and shows the EQ detail area in the GUI channel strip and the GEQ window on the GUI screen.

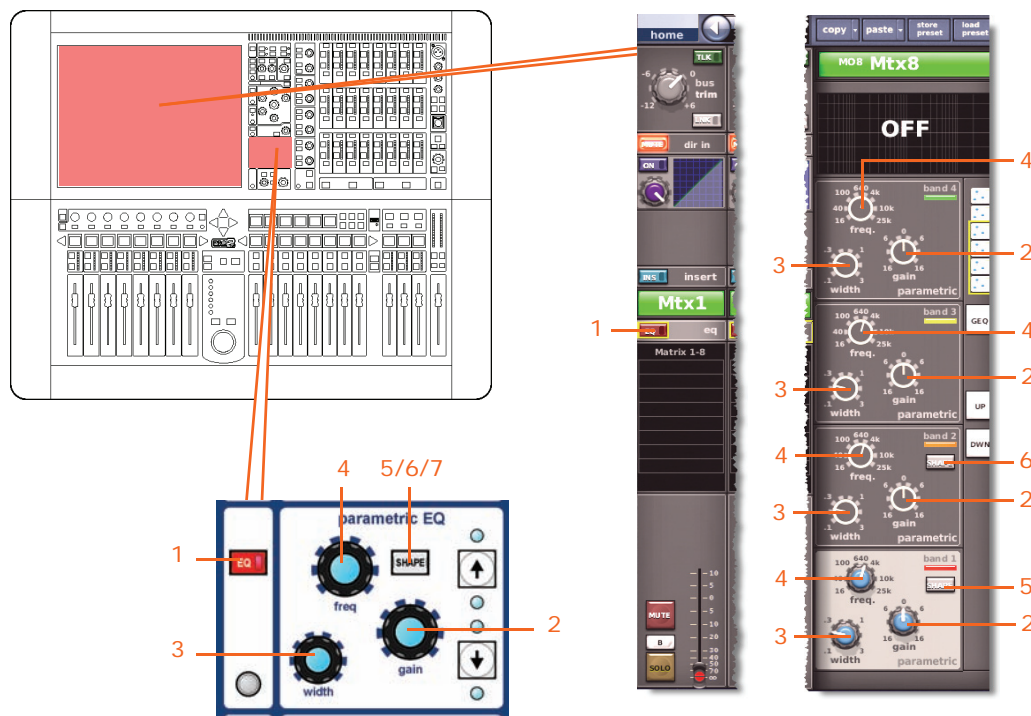

Item	Control	Parameter
1	EQ switch	EQ on/off
2	gain control knob	EQ gain level
3	width control knob	EQ width
4	freq control knob	EQ frequency
5*	SHAPE switch	Selects band 1 shelving modes: parametric, warm, high pass 6dB or high pass 12dB
6*	SHAPE switch	Selects band 2 shelving modes: parametric or high pass 24dB
7	SHAPE switch	Selects band 6 shelving modes: parametric, soft, low pass 6dB or low pass 12dB

\* Not shown in diagram.

**Note:** Although bands 1 and 2 are not shown above, the items in the table also apply. Both bands have items 2, 3 and 4. Additionally, band 1 also has item 7, and band 2 also has item 6.

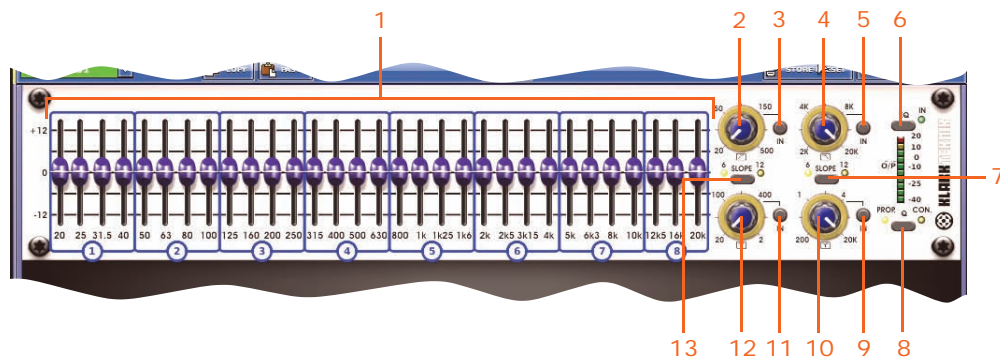

<i>Item</i>	<i>Control</i>	<i>Parameter</i>
1	31 faders	Fader positions
2	High pass filter control knob	High pass filter cut off frequency
3	<b>IN</b> switch	High pass filter in/out
4	Low pass filter control knob	Low pass filter cut off frequency
5	<b>IN</b> switch	Low pass filter in/out
6	<b>EQ</b> switch	EQ in/out
7	<b>SLOPE</b> switch	Selects low pass filter as 6dB or 12dB
8	<b>Q</b> switch	Selects Q mode as proportional ( <b>PROP.</b> ) or constant ( <b>CON.</b> )
9	<b>IN</b> switch	Switches 200Hz - 20kHz notch filter in/out
10	Notch filter control knob	200Hz - 20kHz notch filter frequency
11	<b>IN</b> switch	Switches 20Hz - 2kHz notch filter in/out
12	Notch filter control knob	20Hz - 2kHz notch filter frequency
13	<b>SLOPE</b> switch	Selects high pass filter as 6dB or 12dB



**DYN (dynamic) safe**

The following diagram details the parameters in the matrices protected by the **DYN** safe, and shows the compressor detail area in the GUI channel strip. Only the corrective compressor is shown, but this is typically the same for the other compressor modes (adaptive, creative, vintage and shimmer).

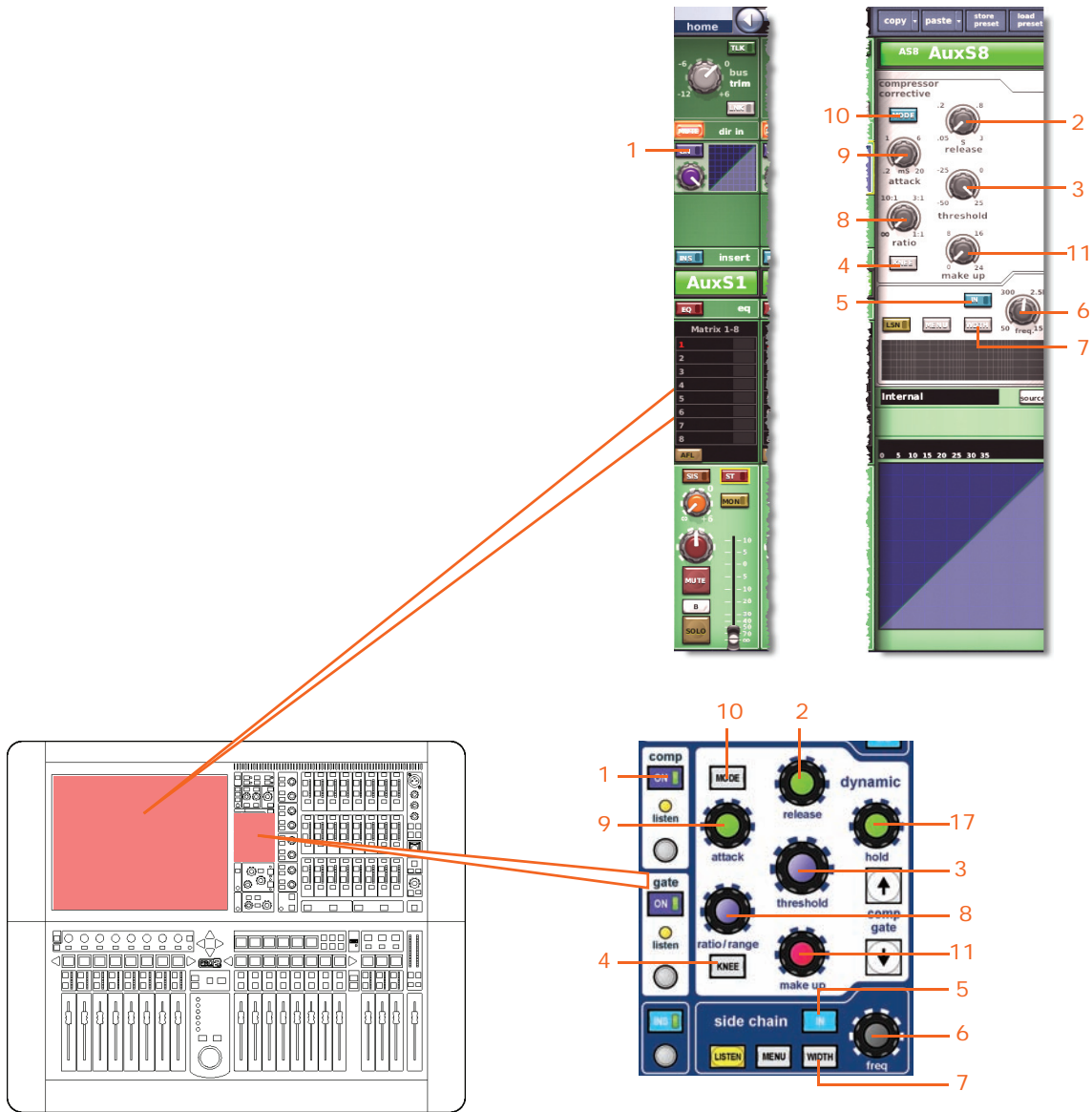

<i>Item</i>	<i>Control</i>	<i>Parameter</i>
1	<b>ON</b> switch	Compressor on/off
2	<b>release</b> control knob	Compressor release
3	<b>threshold</b> control knob	Compressor threshold
4	<b>KNEE</b> pushbutton	Compressor knee (unlabelled) selector: hard, medium and soft
5	<b>IN</b> switch	Compressor sidechain in/out

<i>Item</i>	<i>Control</i>	<i>Parameter</i>
6	<b>freq.</b> control knob	Compressor sidechain frequency
7	<b>WIDTH</b> pushbutton	Compressor sidechain width selector: 2 Oct, 1 Oct and 0.3 Oct
8	<b>ratio</b> control knob	Compressor ratio
9	<b>attack</b> control knob	Compressor attack
10	<b>MODE</b> pushbutton	Compressor mode selector — corrective, adaptive, creative, vintage or shimmer
11	<b>make up</b> control knob	Compressor gain

**MIC safe**

The following diagram details the parameters in the matrices protected by **MIC** safe, and shows the configuration detail area in the GUI channel strip.

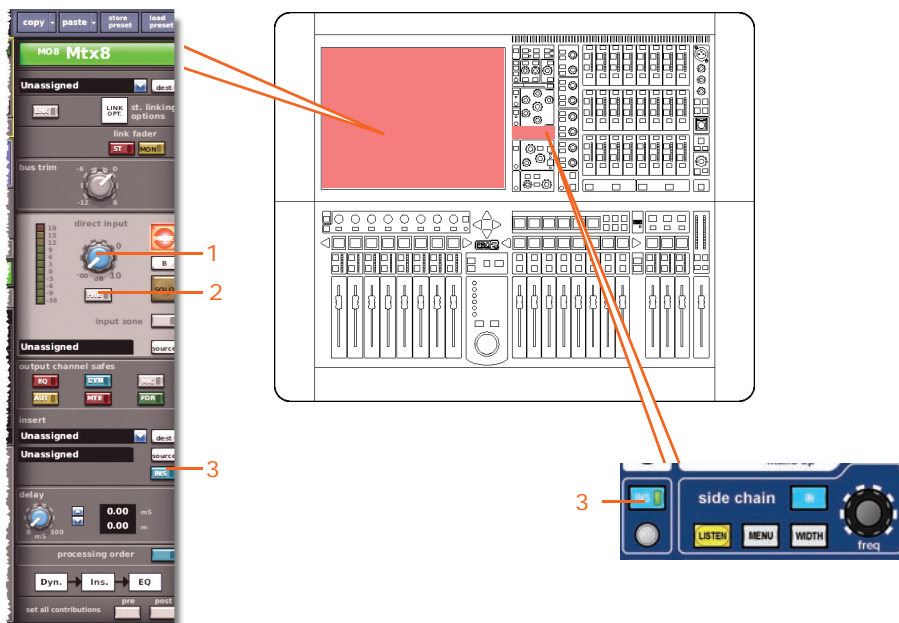

<i>Item</i>	<i>Control</i>	<i>Parameter</i>
1	<b>level</b> control knob	Direct input level
2	<b>MODE/[PRE]</b> switch	Direct input pre- in/out
3	<b>INS</b> switch	Insert in/out

**AUTO (automation) safe**

All of the matrix channel parameters are protected by **AUTO** (automation) safe — except, of course, for the ones unaffected by the safes (see “Matrix parameters not affected by the safes” on page 411).

**MUTE safe**

The following diagram details the parameters of the matrices protected by **MUTE** safe, and shows the master routing detail area in the GUI channel strip.

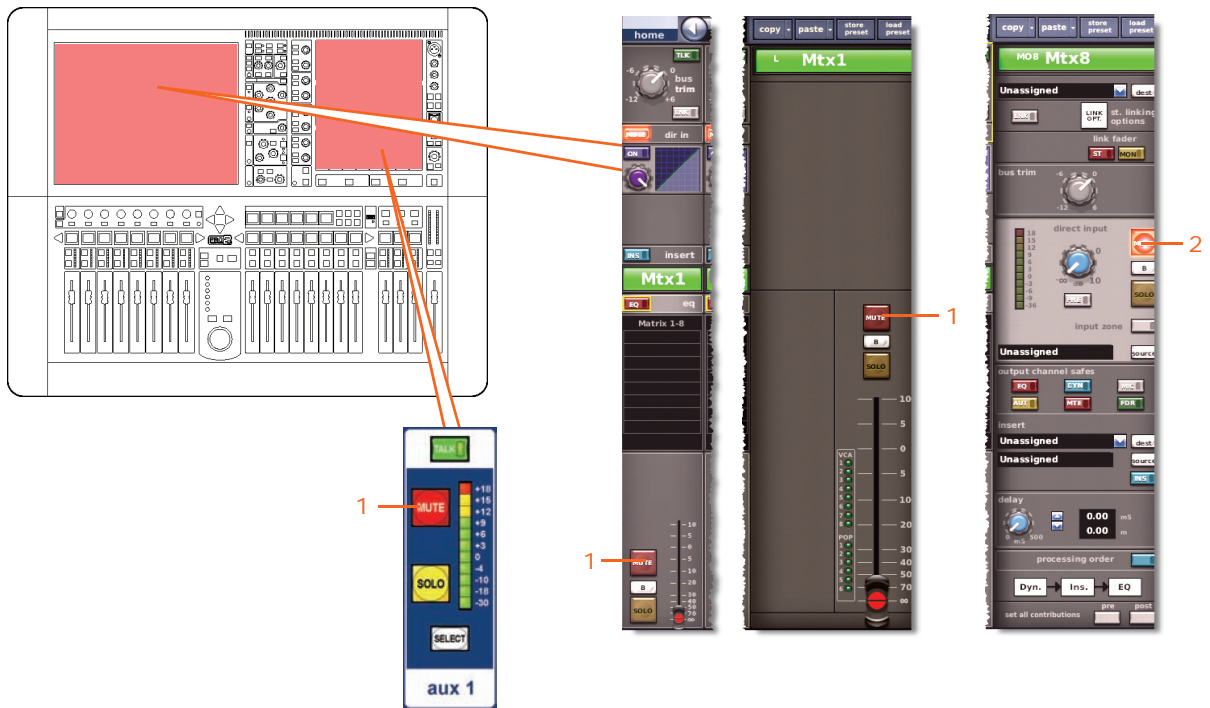

<i>Item</i>	<i>Control</i>	<i>Parameter</i>
1	MUTE switch	Mute on/off
2	MUTE switch	Direct input mute on/off

**FADER safe**

The following diagram details the parameters of the matrices protected by **FADER** safe, and shows the master routing detail area in the GUI channel strip.

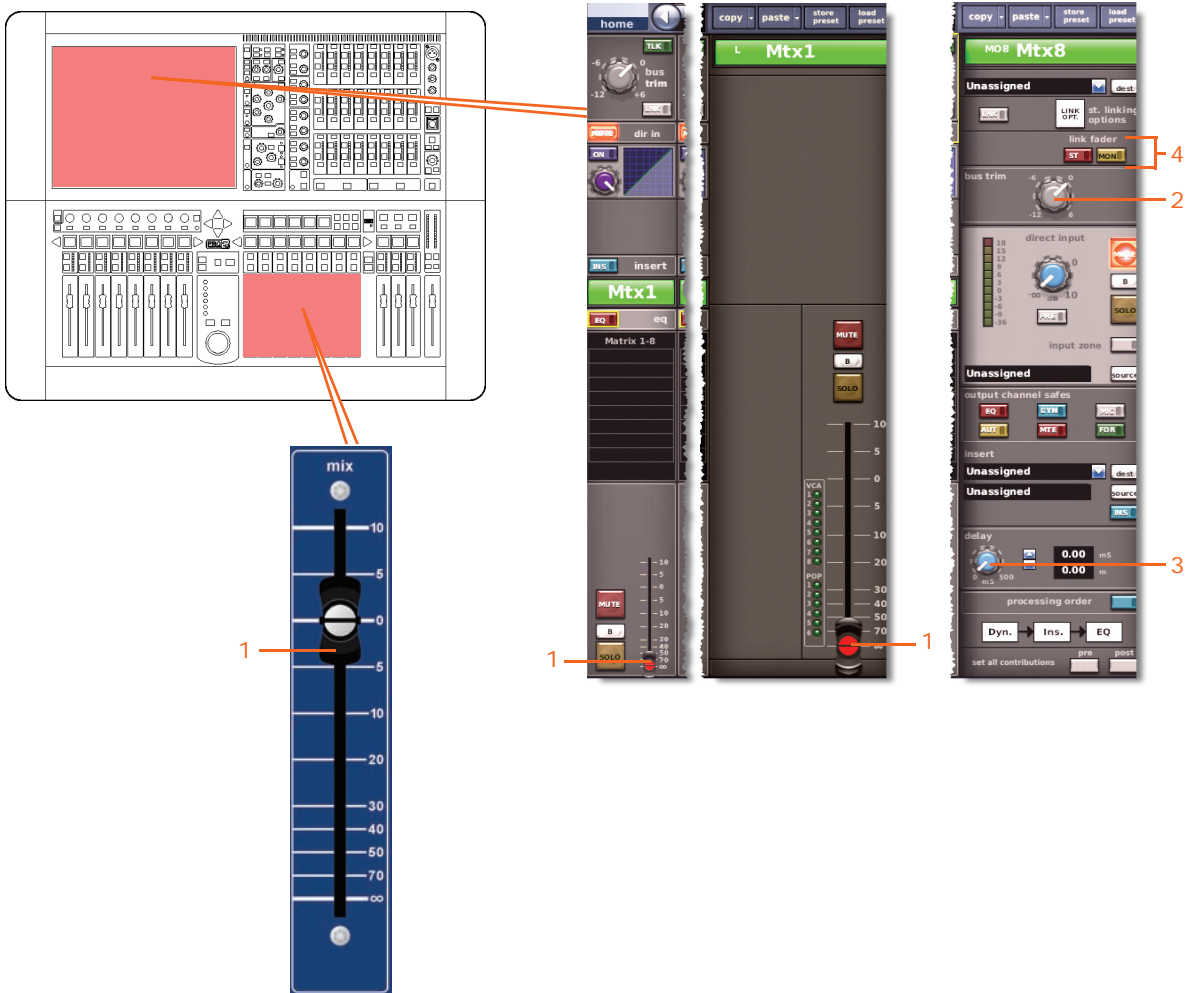

<i>Item</i>	<i>Control(s)</i>	<i>Parameter</i>
1	Fader	Fader level
2	<b>bus trim</b> control knob	Bus trim level
3	<b>delay</b> control knob	Delay time
4	<b>ST</b> switch, <b>MON</b> switch	Linking to stereo/mono master fader switch

## Masters

The master safes are selected via the **output channel safes** section of the output channel strip in the mix bay (control surface) and the configuration detail area of the GUI channel strip.

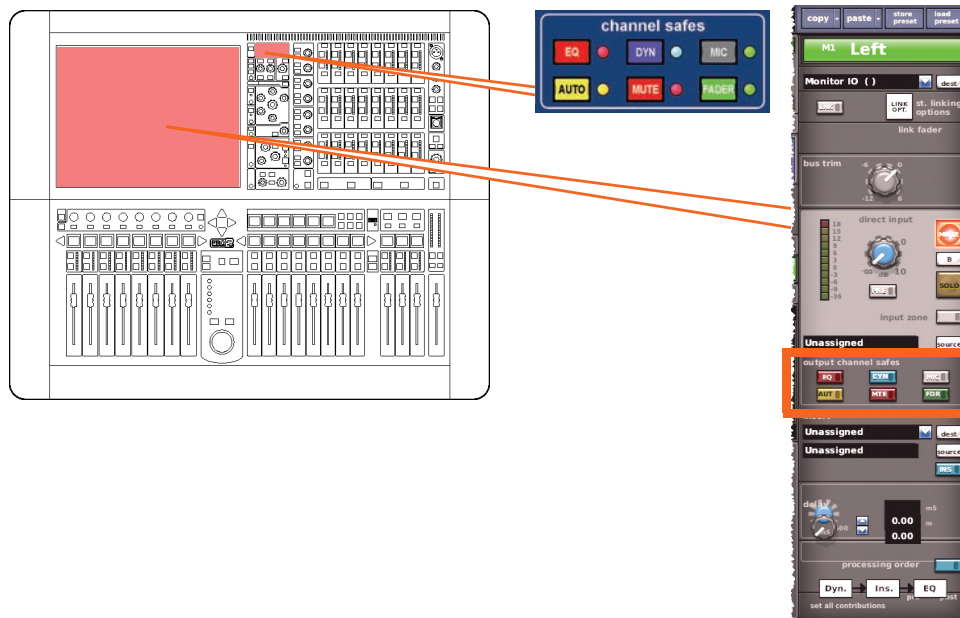

Master parameters not affected by the safes

The following shows you which parameters are *not* affected by each safe.

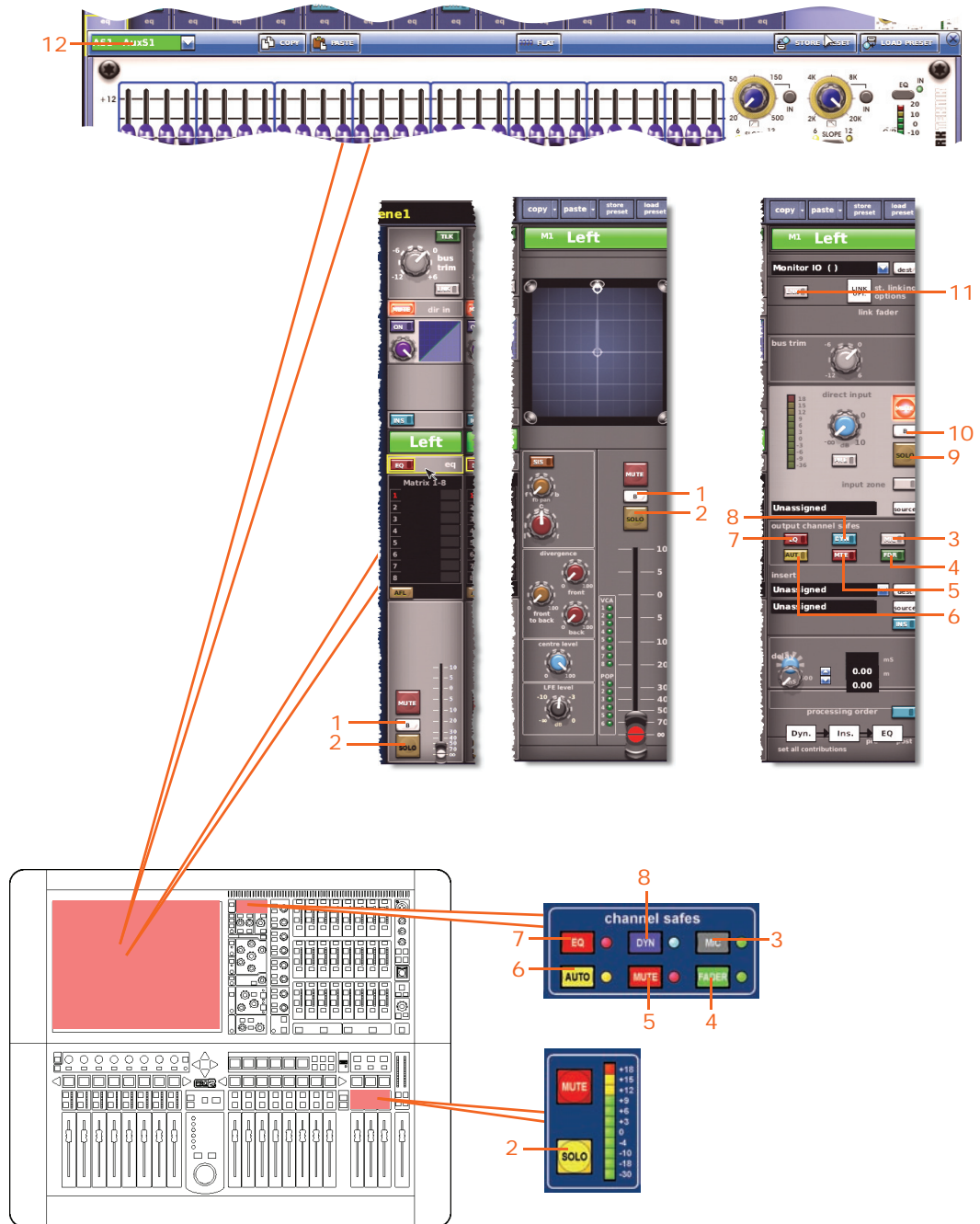

---

<i>Item</i>	<i>Control</i>	<i>Parameter</i>
1	<b>SOLO B/[B]</b> switch	Solo B on/off
2	<b>SOLO</b> switch	Solo on/off
3	<b>MIC</b> switch	Mic safe on/off
4	<b>FADER/[FDR]</b> switch	Fader safe on/off
5	<b>MUTE/[MTE]</b> switch	Mute safe on/off
6	<b>AUTO/[AUT]</b> switch	Automation safe on/off
7	<b>EQ</b> switch	EQ safe on/off
8	<b>DYN</b> switch	Dynamic safe on/off
9	<b>SOLO</b> switch	Direct input solo on/off
10	<b>SOLO B/[B]</b> switch	Direct input solo B on/off
11	<b>LINK</b> switch	Stereo linking
12	Field	GEQ assignment

---



EQ safe

The following diagram details the EQ parameters protected by the **EQ** safe, and shows the EQ detail area in the GUI channel strip and the GEQ window on the GUI screen.

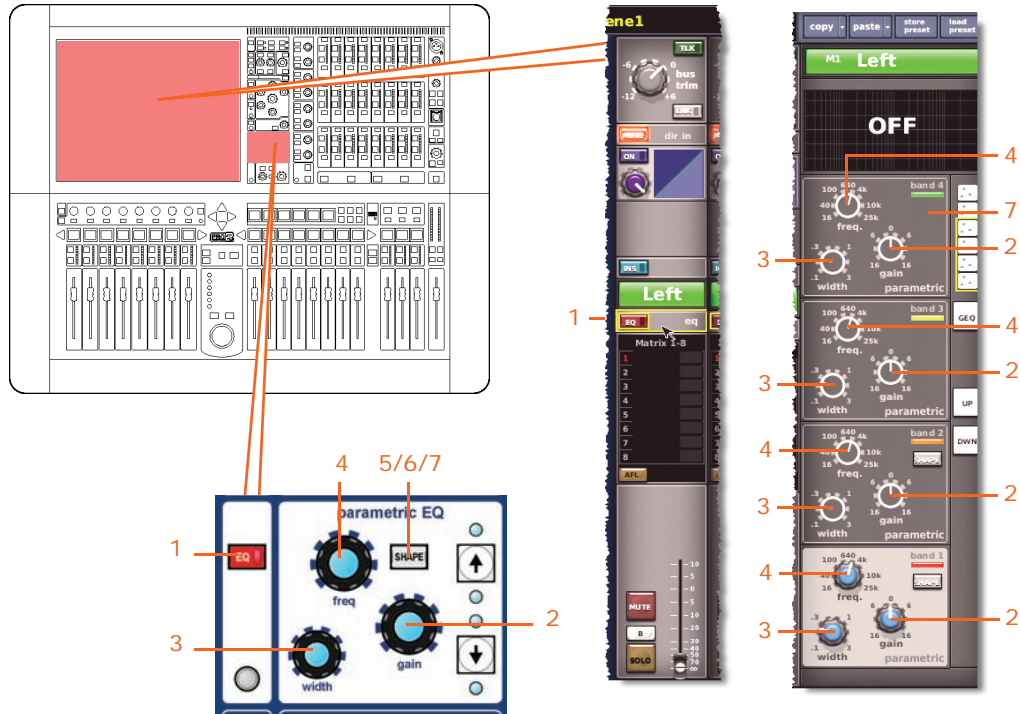

Item	Control	Parameter
1	EQ switch	EQ on/off
2	gain control knob	EQ gain level
3	width control knob	EQ width
4	freq control knob	EQ frequency
5	SHAPE switch	Selects band 6 shelving modes: parametric, soft, low pass 6dB or low pass 12dB
6*	SHAPE switch	Selects band 1 shelving modes: parametric, warm, high pass 6dB or high pass 12dB
7*	SHAPE switch	Selects band 2 shelving modes: parametric or high pass 24dB

\* Not shown in diagram.

**Note:** Although bands 1 and 2 are not shown above, the items in the table also apply. Both bands have items 2, 3 and 4. Additionally, band 1 has item 6, and band 2 has item 7.



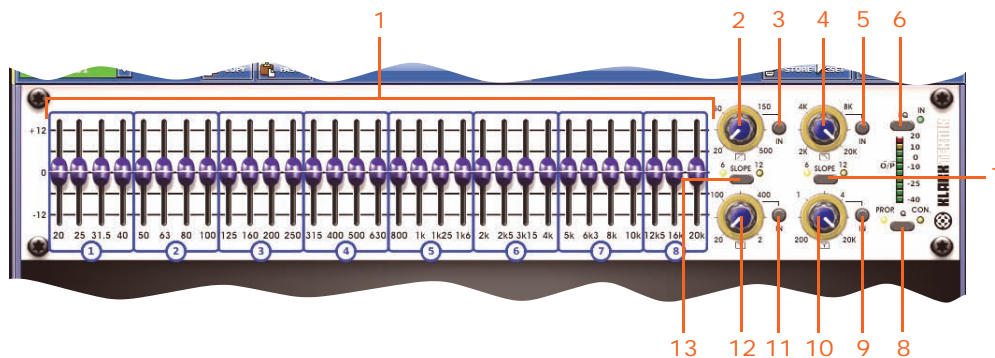

<i>Item</i>	<i>Control</i>	<i>Parameter</i>
1	31 faders	Fader positions
2	High pass filter control knob	High pass filter cut off frequency
3	<b>IN</b> switch	High pass filter in/out
4	Low pass filter control knob	Low pass filter cut off frequency
5	<b>IN</b> switch	Low pass filter in/out
6	<b>EQ</b> switch	EQ in/out
7	<b>SLOPE</b> switch	Selects low pass filter as 6dB or 12dB
8	<b>Q</b> switch	Selects Q mode as proportional ( <b>PROP.</b> ) or constant ( <b>CON.</b> )
9	<b>IN</b> switch	Switches 200Hz - 20kHz notch filter in/out
10	Notch filter control knob	200Hz - 20kHz notch filter frequency
11	<b>IN</b> switch	Switches 20Hz - 2kHz notch filter in/out
12	Notch filter control knob	20Hz - 2kHz notch filter frequency
13	<b>SLOPE</b> switch	Selects high pass filter as 6dB or 12dB

**DYN (dynamic) safe**

The following diagram details the parameters in the masters protected by the **DYN** safe, and shows the compressor detail area in the GUI channel strip. Only the corrective compressor is shown, but this is typically the same for the other compressor modes (adaptive, creative, vintage and shimmer).

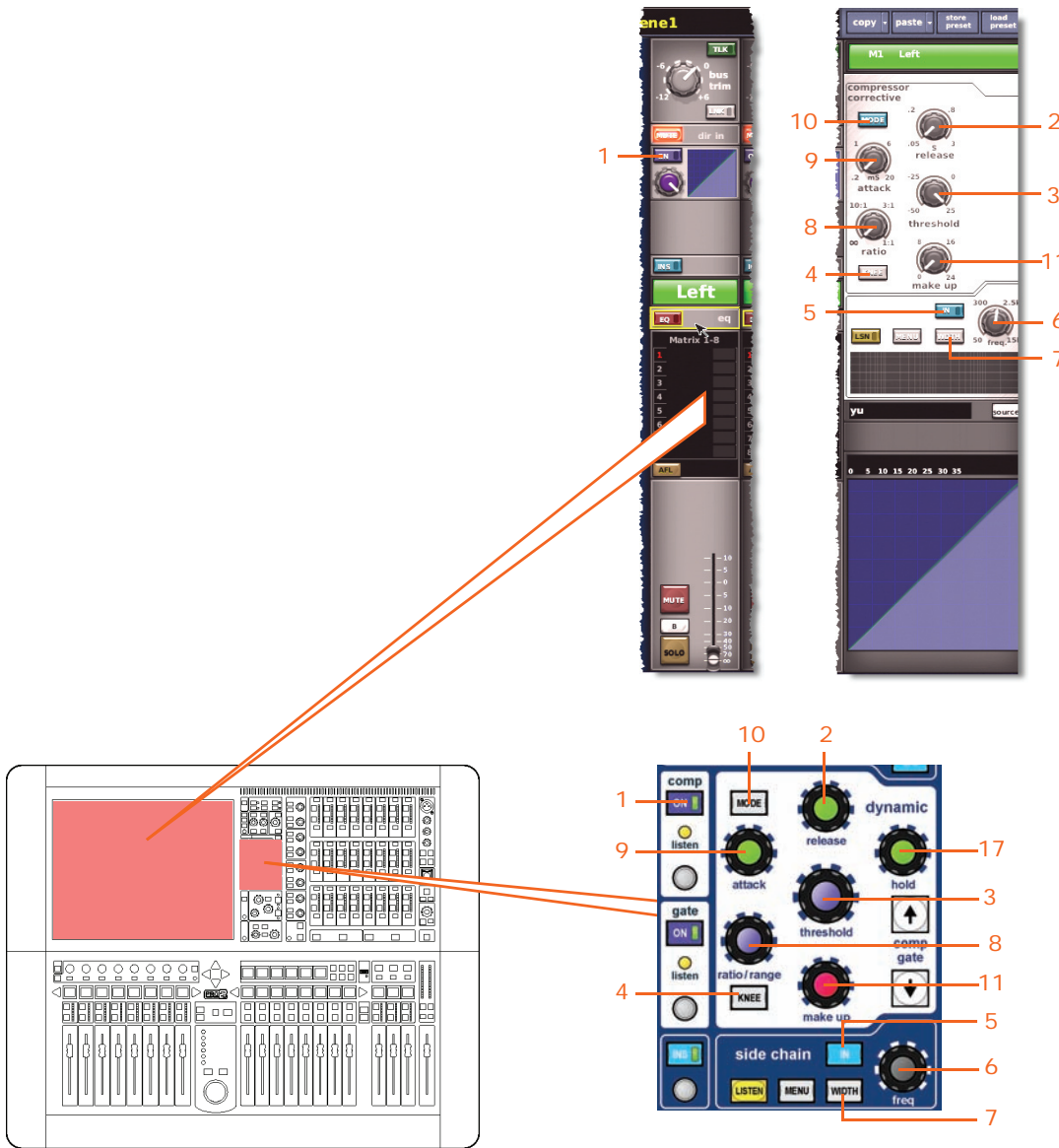

<i>Item</i>	<i>Control</i>	<i>Parameter</i>
1	<b>DYN</b> switch	Compressor on/off
2	<b>release</b> control knob	Compressor release
3	<b>comp threshold/ [threshold]</b> control knob	Compressor threshold
4	<b>KNEE</b> pushbutton	Compressor knee selector: hard, medium and soft
5	<b>IN</b> switch	Compressor sidechain in/out

<i>Item</i>	<i>Control</i>	<i>Parameter</i>
6	<b>freq</b> control knob	Compressor sidechain frequency
7	<b>WIDTH</b> pushbutton	Compressor sidechain width: 2 Oct, 1 Oct or 0.3 Oct
8	<b>ratio</b> control knob	Compressor ratio
9	<b>attack</b> control knob	Compressor attack
10	<b>MODE</b> pushbutton	Compressor mode — corrective, adaptive, creative, vintage or shimmer
11	<b>make up</b> control knob	Compressor gain

**MIC safe**

The following diagram details the parameters in the masters protected by **MIC** safe, and shows the configuration detail area in the GUI channel strip.

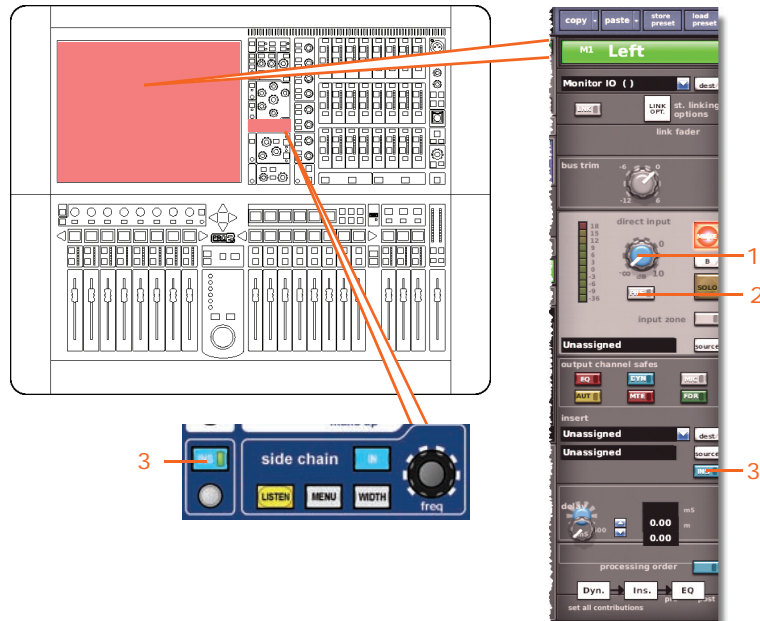

<i>Item</i>	<i>Control</i>	<i>Parameter</i>
1	<b>level</b> control knob	Direct input level
2	<b>MODE/[PRE]</b> switch	Direct input pre- in/out
3	<b>INS</b> switch	Insert in/out

**AUTO (automation) safe**

All of the master channel parameters are protected by **AUTO** (automation) safe — except, of course, for the ones unaffected by the safes (see “Aux parameters not affected by the safes” on page 397).

**MUTE safe**

The following diagram details the parameters of the masters protected by **MUTE** safe, and shows the master routing detail area in the GUI channel strip.

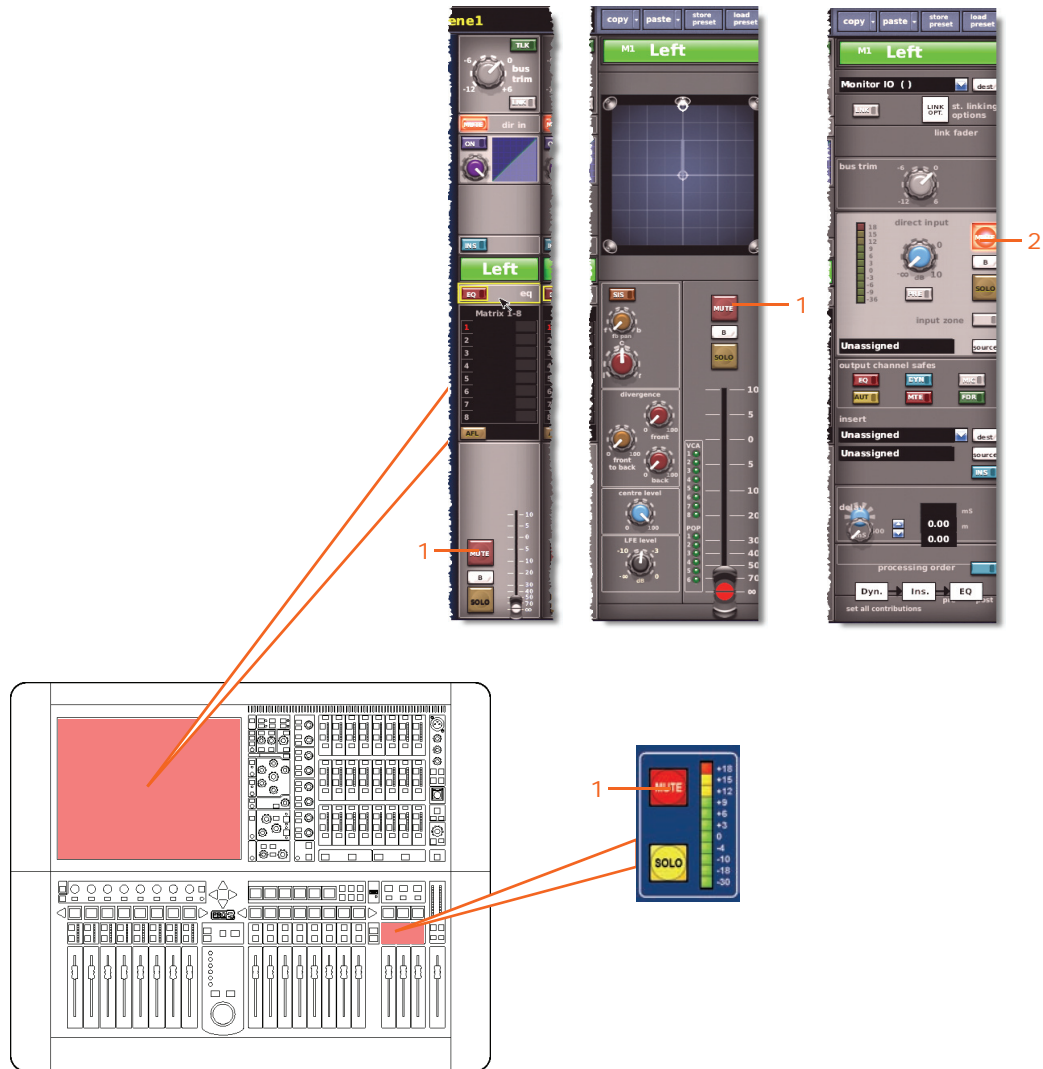

<i>Item</i>	<i>Control</i>	<i>Parameter</i>
<b>1</b>	<b>MUTE</b> switch	Mute on/off
<b>2</b>	<b>MUTE</b> switch	Direct input mute on/off

**FADER safe**

The following diagram details the parameters of the masters protected by **FADER** safe, and shows the master routing detail area in the GUI channel strip.

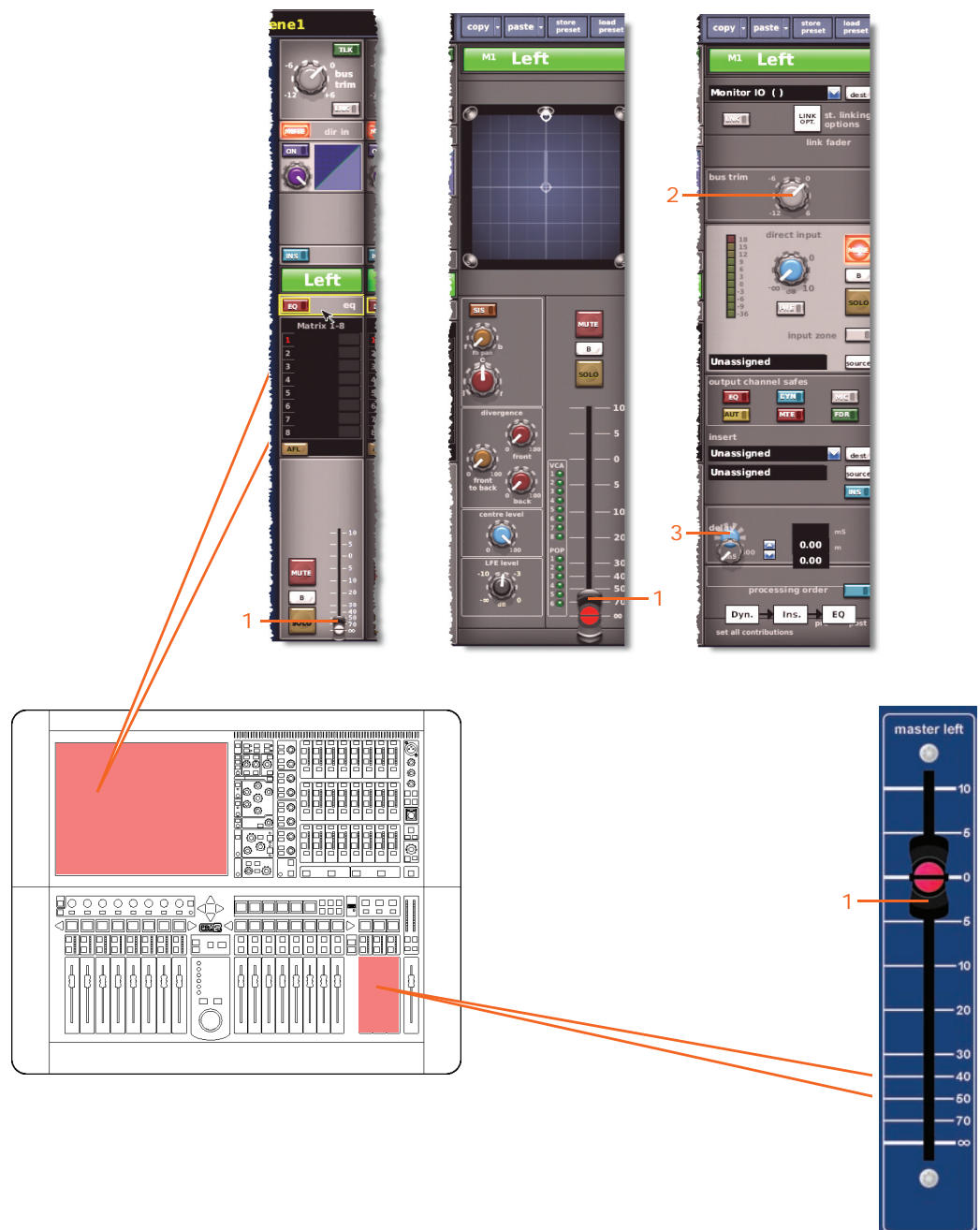

Item	Control	Parameter
1	Fader	Fader level
2	<b>bus trim</b> control knob	Bus trim level
3	<b>delay</b> control knob	Delay time

## Groups

The group safes — mute and fader — are selected via the **VCA Groups** screen of the GUI (shown below).

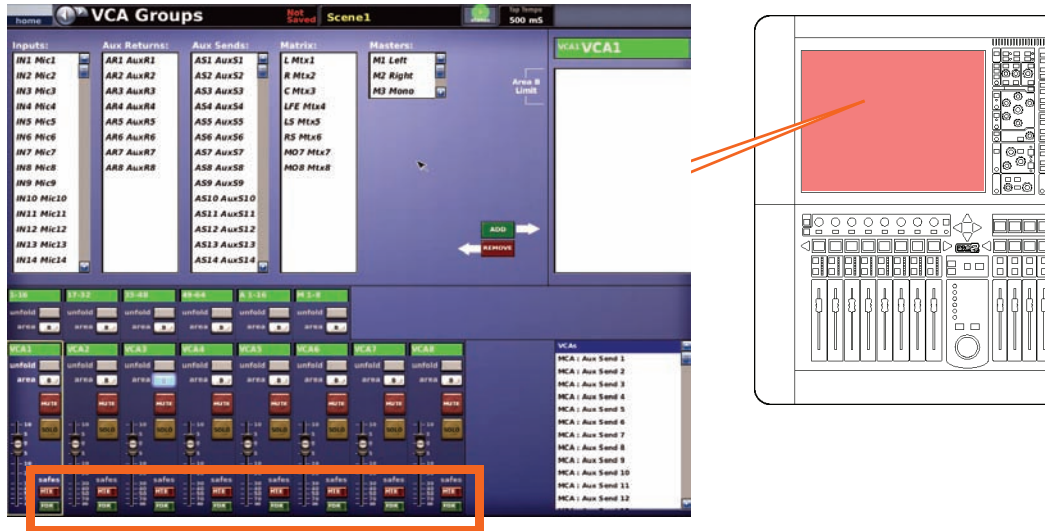

### EQ safe

Not applicable.

### Dynamic safe

Not applicable.

### Mic safe

Not applicable.

**Automation safe**

The following diagram shows the parameters of the VCA groups protected by the **AUT** (auto) safe.

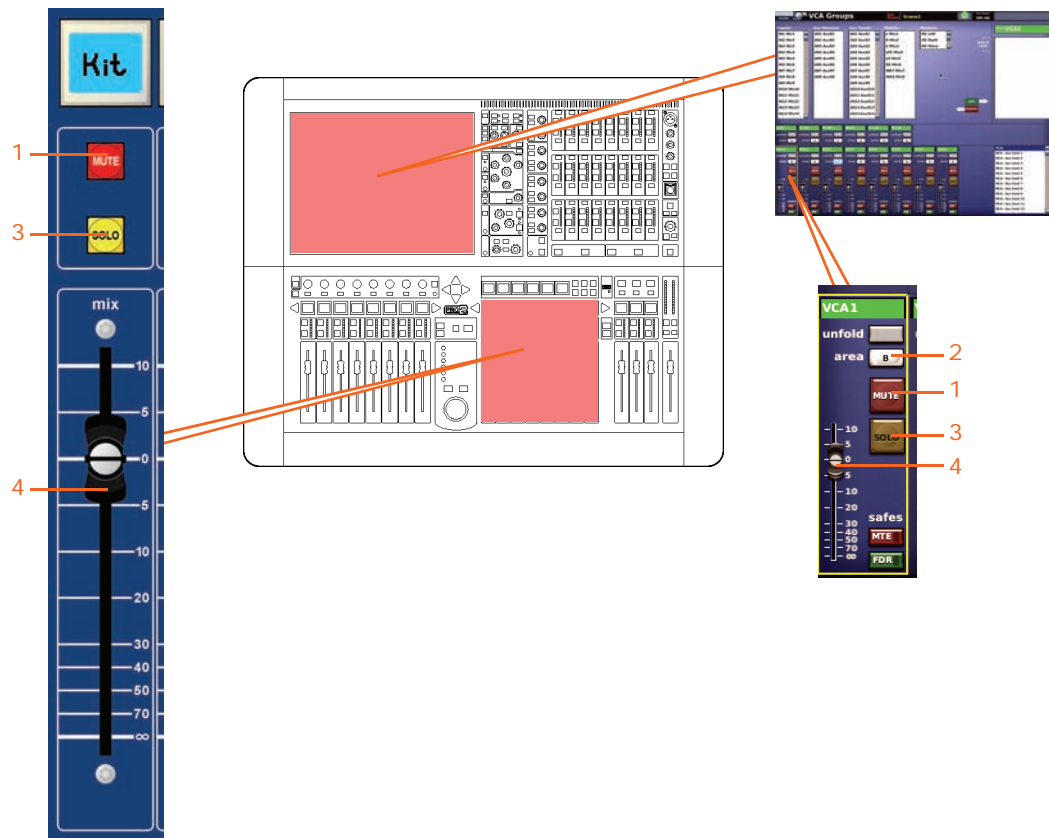

<i>Item</i>	<i>Control</i>	<i>Parameter</i>
1	MUTE switch	Mute on/off
2	SOLO B/[B] switch	Solo B on/off
3	SOLO switch	Solo on/off
4	Fader	Fader level



**Mute (MTE) safe**

The following diagram shows the parameters of the VCA groups protected by the **MTE** (mute) safe.

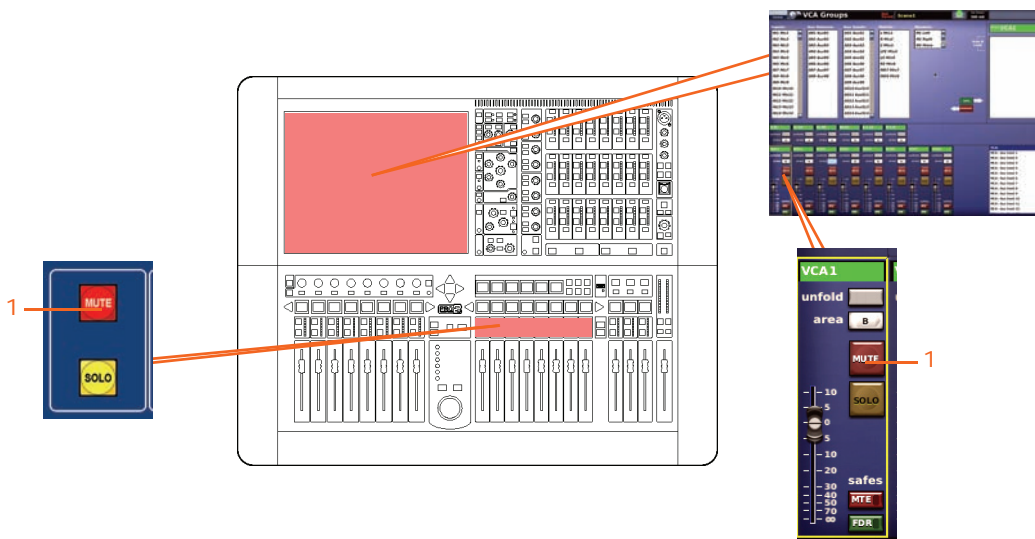

<i>Item</i>	<i>Control</i>	<i>Parameter</i>
1	MUTE switch	Mute on/off

**Fader (FDR) safe**

The following diagram shows the parameters of the VCA groups protected by **FDR** (fader) safe.

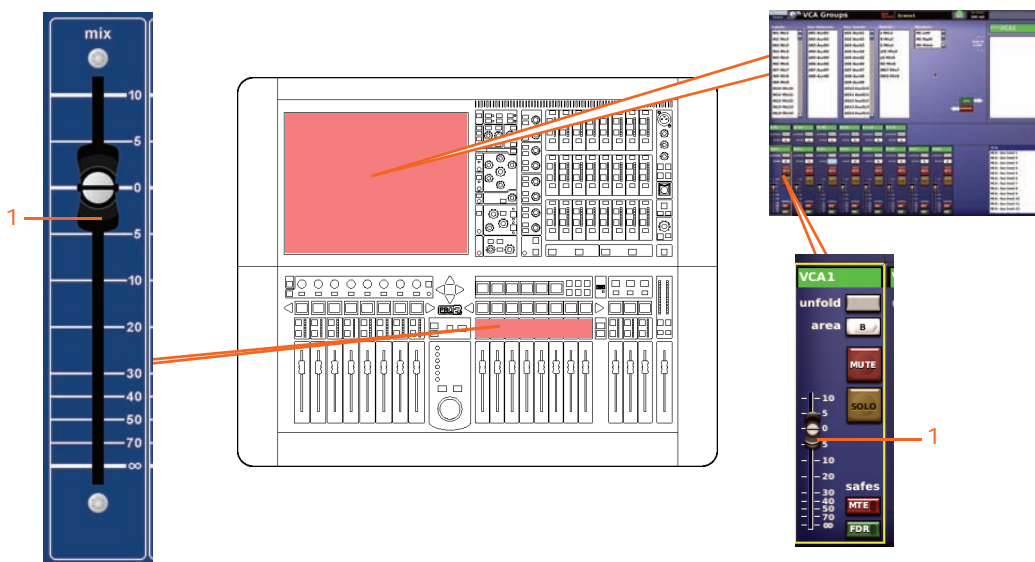

<i>Item</i>	<i>Control</i>	<i>Parameter</i>
1	Fader	Fader level



## Appendix I: Parameters Affected By Copy And Paste

This appendix shows the input and output channel parameters affected by copy and paste operations, which are selected via the copy and paste buttons on the GUI (see "Using copy and paste" on page 87).

The structure of this appendix is intended to follow the way that copy and paste operates, that is, by channel or detail area.

### Overview

The following table provides a quick reference for finding the copy and paste parameters per channel in this appendix.

<b>Control area</b>	<b>Inputs</b>	<b>Auxes</b>	<b>Returns</b>	<b>Matrices</b>	<b>Masters</b>
<b>Configuration</b>	"Configuration" on page 432	"Configuration" on page 440	"Configuration" on page 446	"Configuration" on page 449	"Configuration" on page 455
<b>Compressor</b>	"Compressor" on page 433	"Compressor" on page 441	N/A	"Compressor" on page 450	"Compressor" on page 456
<b>Gate</b>	"Gate" on page 434	N/A	N/A	N/A	N/A
<b>EQ (GEQ)</b>	"EQ" on page 436	"EQ (GEQ)" on page 442	N/A	"EQ (GEQ)" on page 452	"EQ (GEQ)" on page 458
<b>Bus sends</b>	"Bus sends" on page 438	"Bus sends" on page 444	"Bus sends" on page 447	N/A	N/A
<b>Master routing /fader section</b>	"Master routing" on page 439	"Master routing" on page 445	"Master routing" on page 448	"Fader section" on page 454	"Master routing" on page 460

## Inputs

This section shows you which input channel parameters are affected by copy and paste.

### Configuration

The following diagram shows the parameters of the configuration detail area affected by copy and paste.

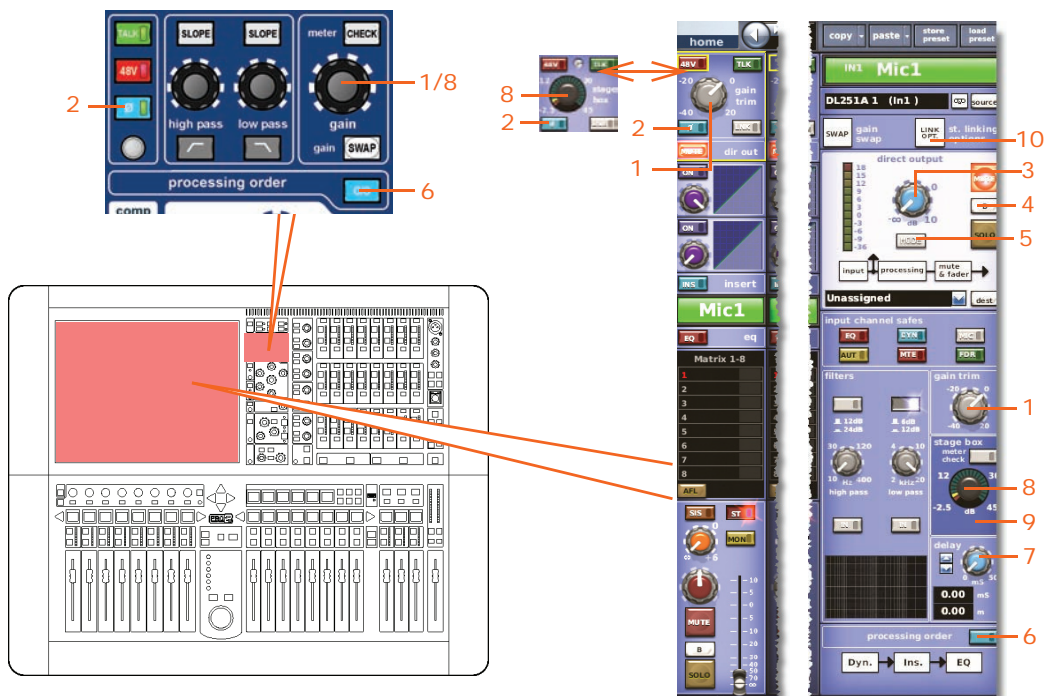

Item	Control	Parameter
1	gain trim control knob	Digital trim
2	Ø switch	Phase invert on/off switch
3	level control knob	Direct output level
4	SOLO B/[B] switch	Direct output solo B on/off
5	MODE switch	Direct output tap-off point: "Post-fade and mute", "Pre-mute, pre-processing" and "Pre-mute, post-processing"
6	C/O switch	Order of processing: <b>Dyn.</b> → <b>Ins.</b> → <b>EQ</b> or <b>EQ</b> → <b>Ins.</b> → <b>Dyn.</b>
7	delay control knob	Delay time
8	stage box control knob	Gain of remote amplifier
9	30Hz filter switch	30Hz filter in/out
10	st. link options pushbutton	Stereo linking options

Compressor

This section shows the compression parameters of the dynamics section affected by copy and paste.

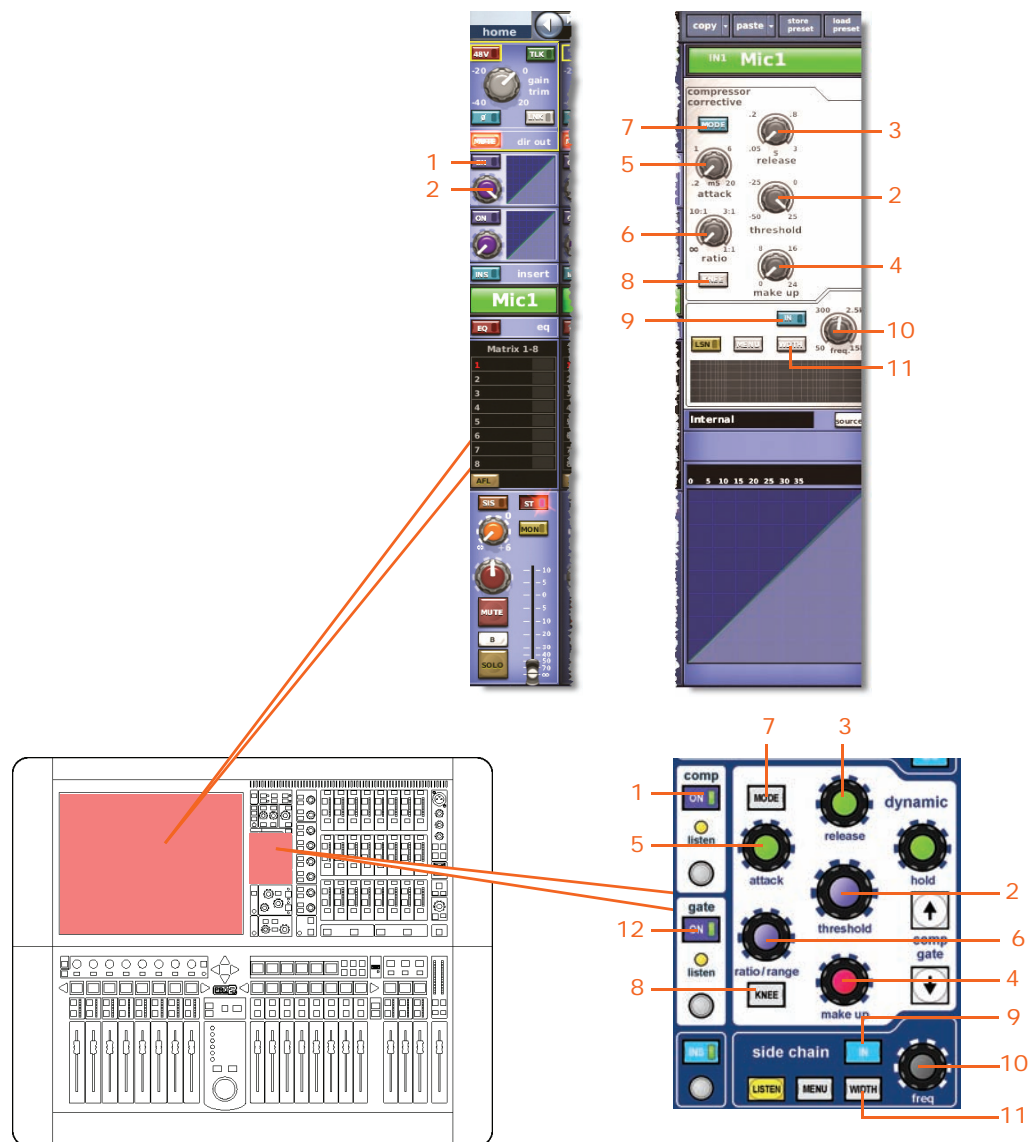

**Note:** Only the corrective compressor is shown above, but this is typically the same for the other compressor modes (adaptive, creative and vintage).

Item	Control	Parameter
1	ON switch	Compressor on/off
2	threshold control knob	Compressor threshold
3	release control knob	Compressor release
4	gain/[make up] control knob	Compressor make up gain
5	attack control knob	Compressor attack

Item	Control	Parameter
6	ratio/range/[ratio] control knob	Compressor ratio
7	MODE pushbutton	Compressor mode selector: corrective (shown above), adaptive, creative and vintage
8	KNEE pushbutton	Compressor knee: hard, medium or soft
9	IN switch	Compressor sidechain in/out
10	freq control knob	Compressor sidechain frequency
11	WIDTH pushbutton	Compressor sidechain width: 2 Oct, 1 Oct or 0.3 Oct

Gate

This section shows the gate parameters of the dynamics section affected by copy and paste.

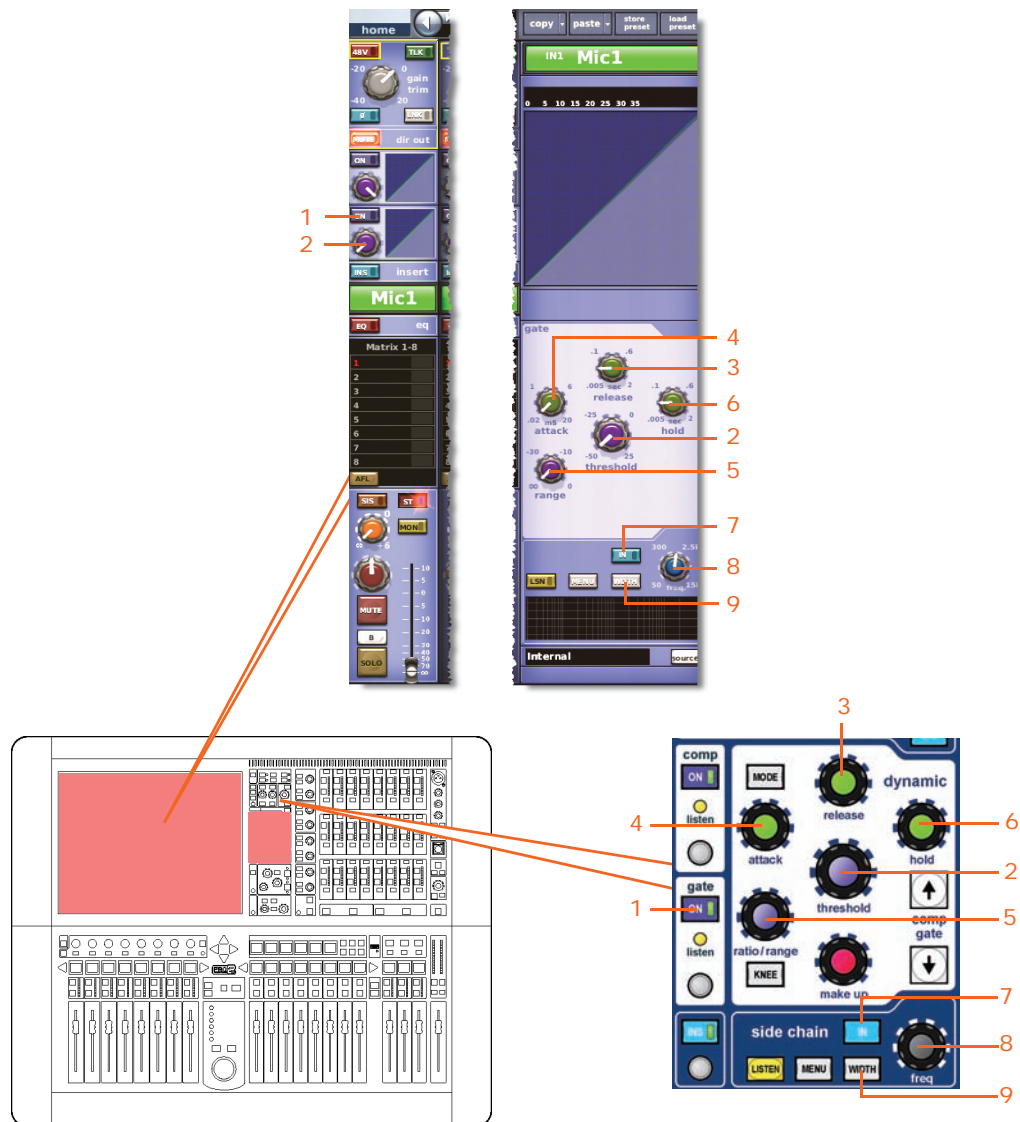

---

<i>Item</i>	<i>Control</i>	<i>Parameter</i>
1	<b>ON</b> switch	Gate on/off
2	<b>threshold</b> control knob	Gate threshold
3	<b>release</b> control knob	Gate release
4	<b>attack</b> control knob	Gate attack
5	<b>range</b> control knob	Gate range
6	<b>hold</b> control knob	Gate hold
7	<b>IN</b> switch	Gate sidechain in/out
8	<b>freq</b> control knob	Gate sidechain frequency
9	<b>WIDTH</b> pushbutton	Gate sidechain width: 2 Oct, 1 Oct or 0.3 Oct

---

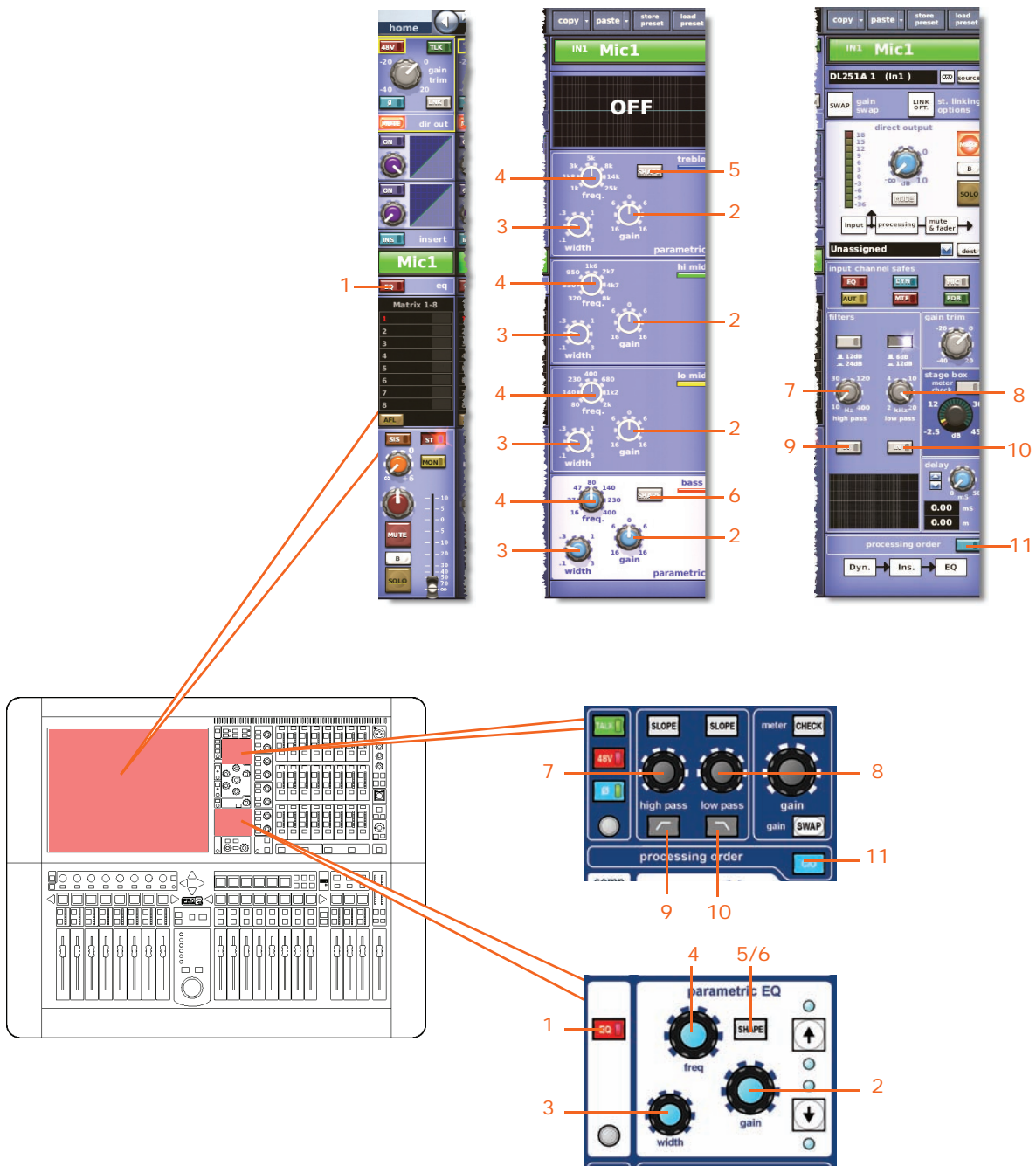

EQ

This section shows all the parameters of the EQ section affected by copy and paste.



Item	Control	Parameter
1	EQ switch	EQ on/off
2	gain control knob	EQ gain level
3	width control knob	EQ width
4	freq control knob	EQ frequency

---

<i>Item</i>	<i>Control</i>	<i>Parameter</i>
5	<b>SHAPE</b> switch	Treble shelving mode: parametric, bright, classic or soft
6	<b>SHAPE</b> switch	Bass shelving mode: parametric, deep, classic or warm
7	<b>high pass</b> control knob	High pass filter frequency
8	<b>low pass</b> control knob	Low pass filter frequency
9	 /[IN] switch	High pass filter in/out
10	 /[IN] switch	Low pass filter in/out
11	<b>C/O</b> switch	To swap the order of processing

---



**Bus sends**

This section shows the parameters of the mix sections affected by copy and paste.

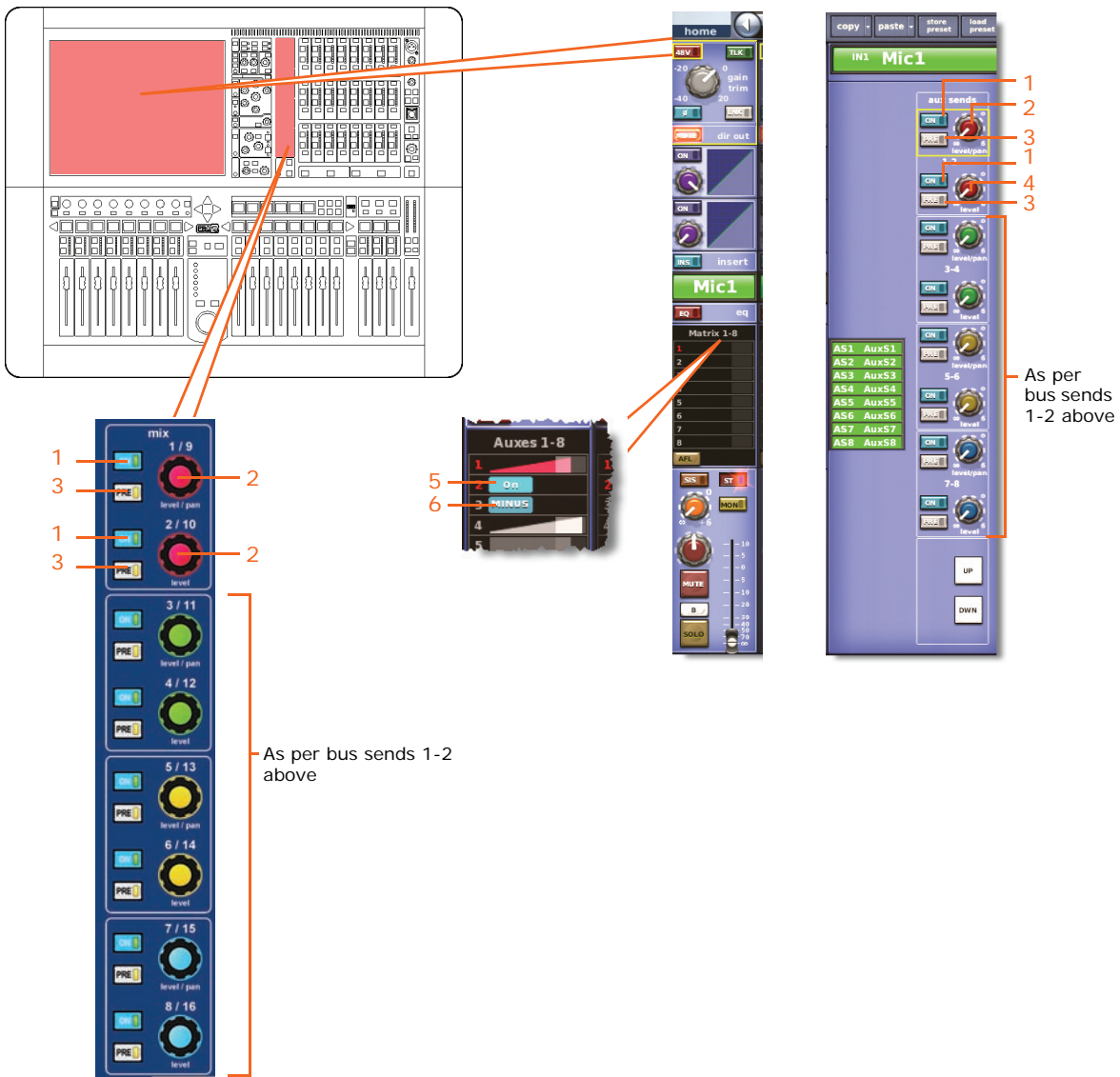

**Note:** Only matrix sends 1 to 8 are shown above, but a copy/paste operation affects all aux and matrix sends.

Item	Control	Parameter
1	ON switch	Bus send on/off
2	level/pan control knob	Bus level, or pan when bus is linked
3	PRE switch	Pre-fader on/off
4	level control knob	Bus level
5	On switch	Aux bus send on/off — only available when aux bus is in group mode
6	MINUS switch	Aux bus send mute on/off — only available when aux bus is in mix minus mode



### Master routing

This section shows all the parameters of the master routing affected by copy and paste.

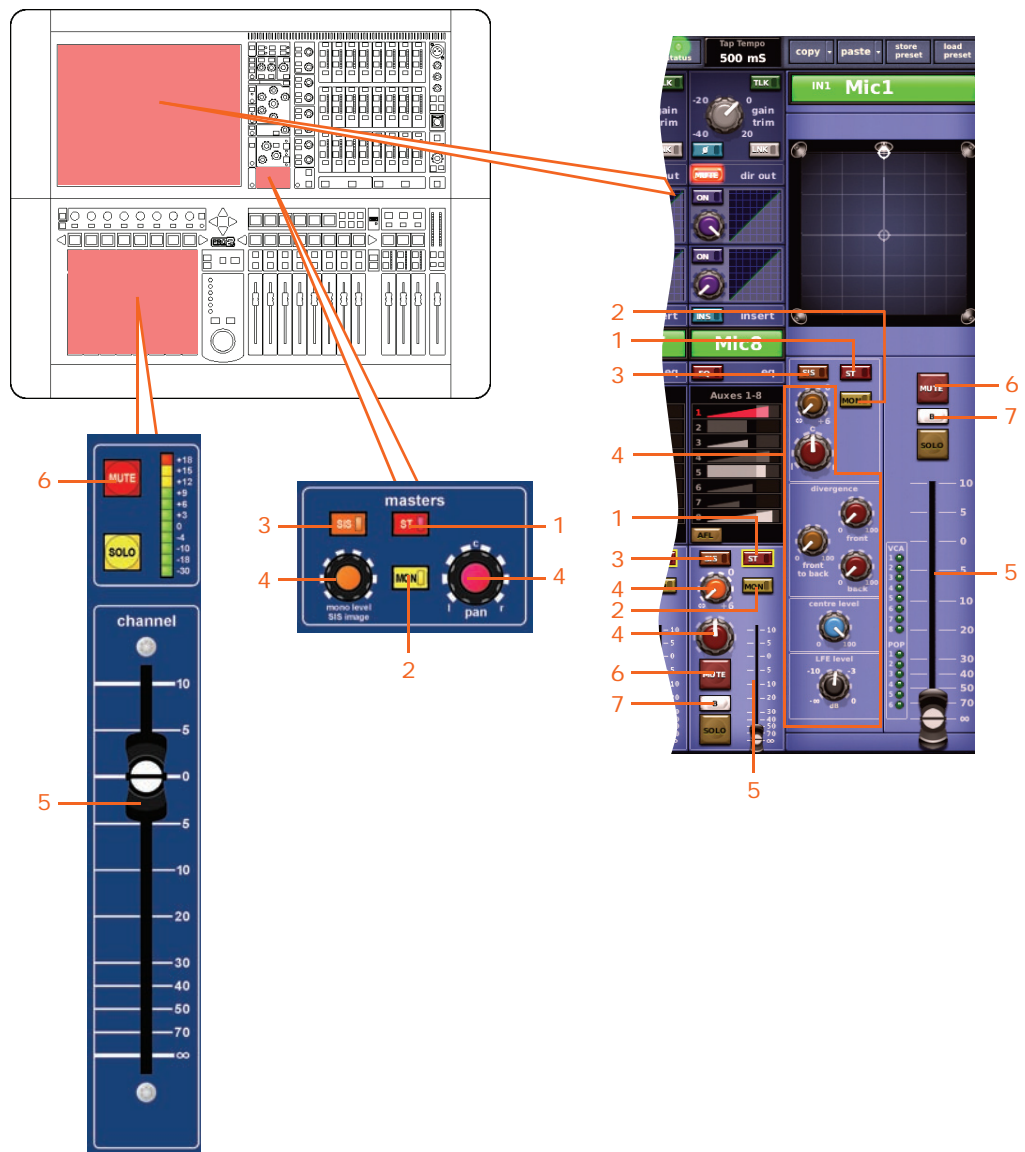

Item	Control	Parameter
1	ST switch	Stereo on/off
2	MON switch	Mono on/off
3	SIS switch	Spatial imaging system on/off
4	Panning control knobs	Surround panning (includes all surround sound parameters)
5	Fader	Level
6	MUTE switch	Mute on/off
7	SOLO B/[B] switch	Solo B on/off

# Aux

This section shows you which aux channel parameters are affected by copy and paste.

## Configuration

The following diagrams show the configuration parameters affected by copy and paste.

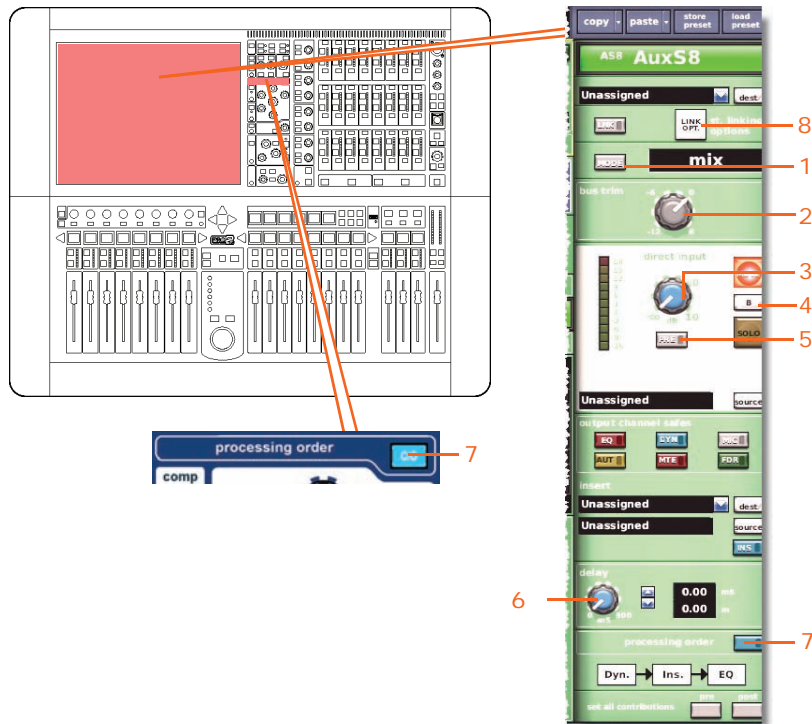

Item	Control	Parameter
1	<b>MODE</b> pushbutton	Bus mode: mix, group or mix minus
2	<b>bus trim</b> control knob	Bus trim level
3	<b>level</b> control knob	Direct input level
4	<b>SOLO B/[B]</b> switch	Direct input solo B on/off
5	<b>MODE/[PRE]</b> switch	Direct input pre- in/out
6	<b>delay</b> control knob	Delay time
7	<b>C/O</b> switch	Order of processing: <b>Dyn.→Ins.→EQ</b> or <b>EQ→Ins.→Dyn.</b>
8	<b>st. linking options</b> button	Stereo linking options

### Compressor

This section shows all the compression parameters of the dynamics section affected by copy and paste. Only corrective compressor shown below, but this is typically the same for the other compressor modes.

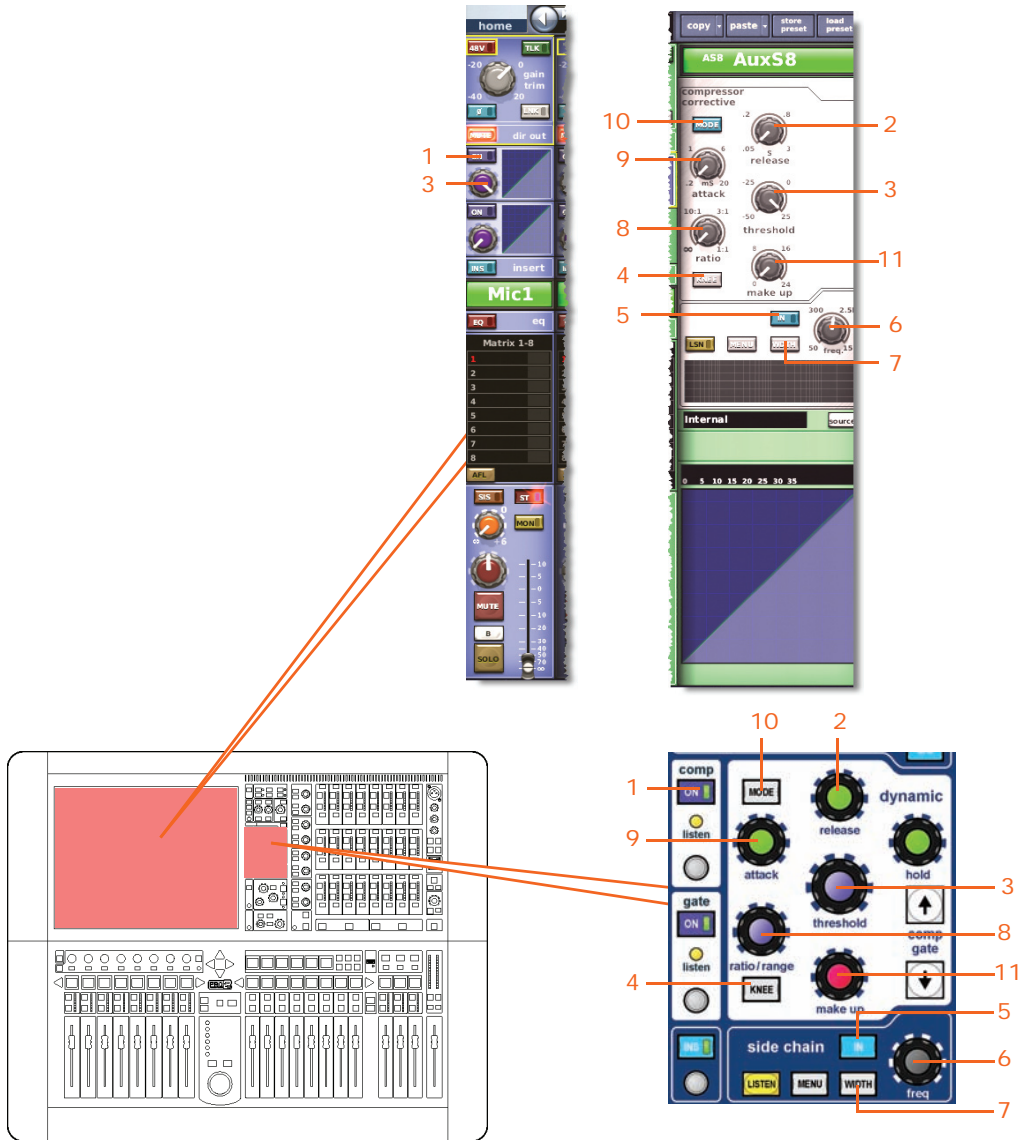

Item	Control	Parameter
1	<b>DYN</b> switch	Compressor on/off
2	<b>release</b> control knob	Compressor release
3	<b>threshold</b> control knob	Compressor threshold
4	<b>KNEE</b> pushbutton	Compressor knee: hard, medium or soft
5	<b>IN</b> switch	Compressor sidechain in/out
6	<b>freq</b> control knob	Compressor sidechain frequency
7	<b>WIDTH</b> pushbutton	Compressor sidechain: 2 Oct, 1 Oct or 0.3 Oct

Item	Control	Parameter
8	ratio/range control knob	Compressor ratio
9	attack control knob	Compressor attack
10	MODE pushbutton	Compressor mode: corrective, adaptive, creative, vintage or shimmer
11	make up control knob	Compressor gain

**Gate**

Not applicable.

**EQ (GEQ)**

This section shows all the parameters of the EQ section, including the GEQ, affected by copy and paste.

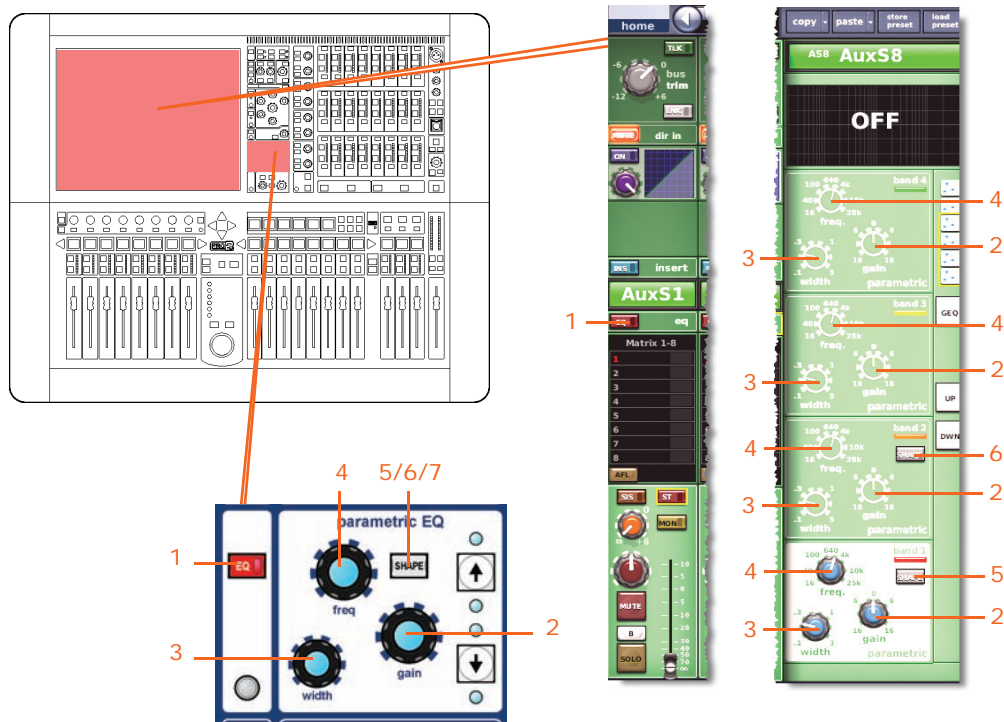

Item	Control	Parameter
1	EQ switch	EQ on/off
2	gain control knob	EQ gain level
3	width control knob	EQ width
4	freq control knob	EQ frequency
5	SHAPING switch	Band 1 shelving mode: bell, warm, high pass 6dB or high pass 12dB

Item	Control	Parameter
6	<b>SHAPE</b> switch	Band 2 shelving mode: bell or high pass 24dB
7*	<b>SHAPE</b> switch	Band 6 shelving mode: bell, soft, low pass 6dB or low pass 12dB

\* Not shown in diagram.

**Note:** Although bands 5 and 6 are not shown above, the items in the table also apply. Both bands have items 2, 3 and 4, and band 6 also has item 7.

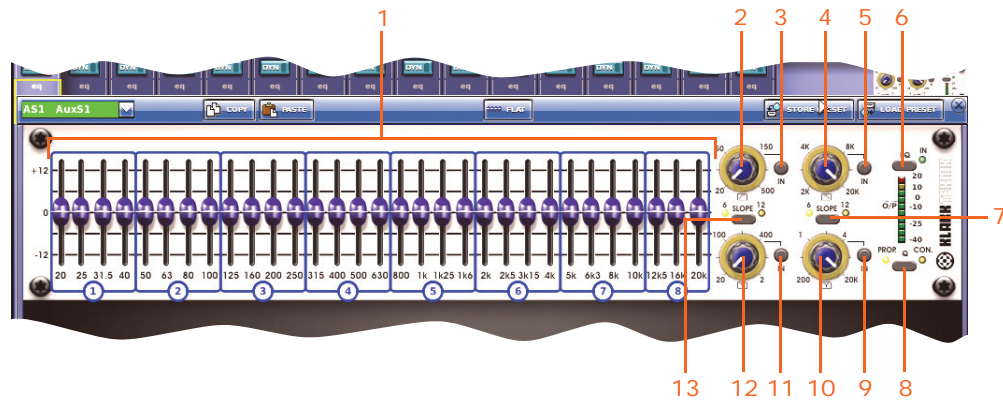

Item	Control	Parameter
1	31 faders	Fader positions
2	High pass filter control knob	High pass filter cut off frequency
3	<b>IN</b> switch	High pass filter in/out
4	Low pass filter control knob	Low pass filter cut off frequency
5	<b>IN</b> switch	Low pass filter in/out
6	<b>EQ</b> switch	EQ in/out
7	<b>SLOPE</b> switch	Low pass filter: 6dB or 12dB
8	<b>Q</b> switch	Q mode as proportional ( <b>PROP.</b> ) or constant ( <b>CON.</b> )
9	<b>IN</b> switch	200Hz - 20kHz notch filter in/out
10	Notch filter control knob	200Hz - 20kHz notch filter frequency
11	<b>IN</b> switch	20Hz - 2kHz notch filter in/out
12	Notch filter control knob	20Hz - 2kHz notch filter frequency
13	<b>SLOPE</b> switch	High pass filter: 6dB or 12dB

**Bus sends**

This section shows the parameters of the mix buses affected by copy and paste.

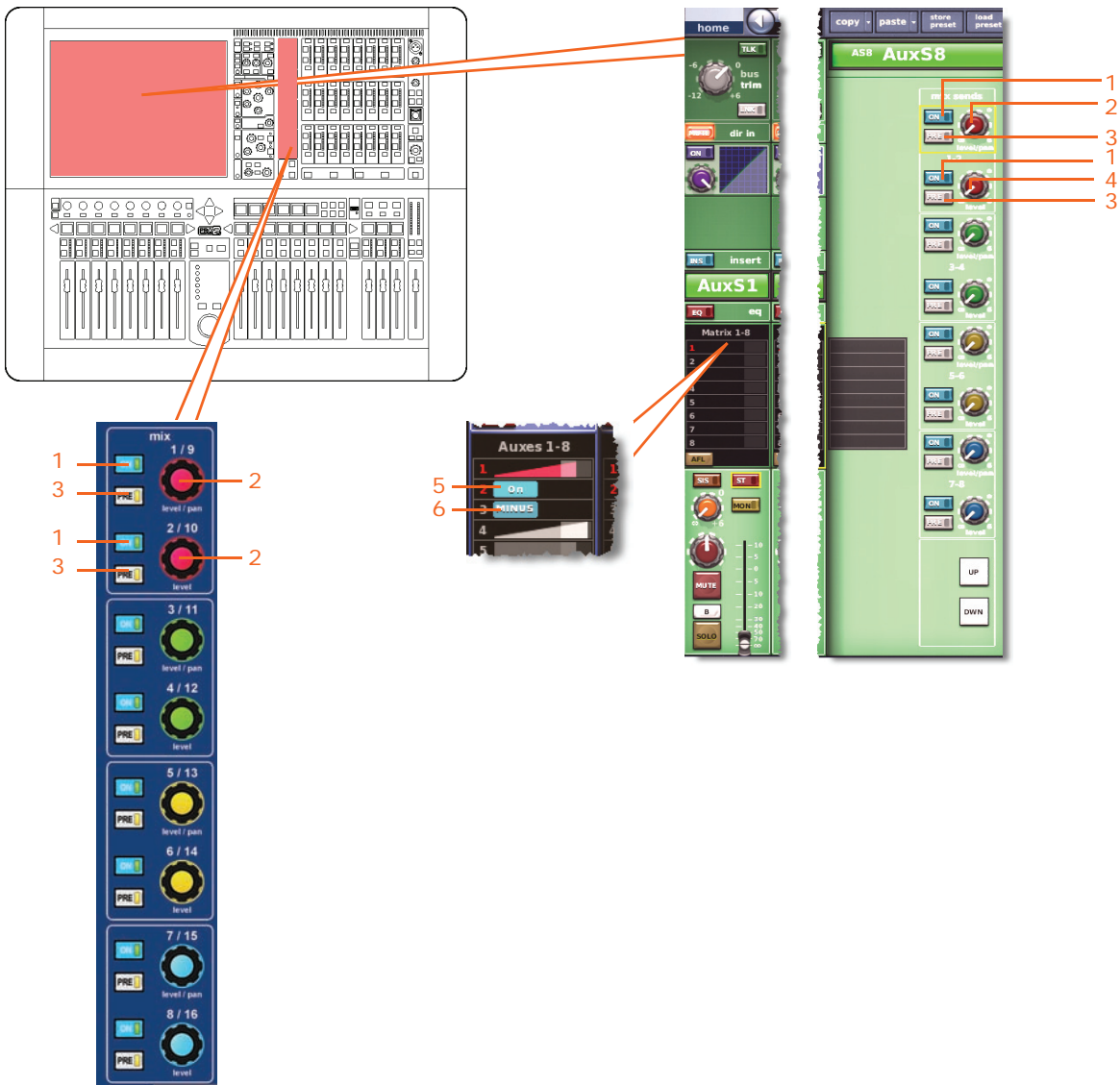

**Note:** Although only matrix sends 1-2 are referenced above, this also applies to all 16 matrix sends.

Item	Control	Parameter
1	ON switch	Matrix bus send on/off
2	level/pan control knob	Bus level, or pan when bus is linked
3	PRE switch	Pre-fader on/off
4	level control knob	Bus level
5	On switch	Aux bus send on/off — only available when aux bus is in group mode
6	MINUS switch	Aux bus send mute on/off — only available when aux bus is in mix minus mode



### Master routing

This section shows all the parameters of the master routing section affected by copy and paste.

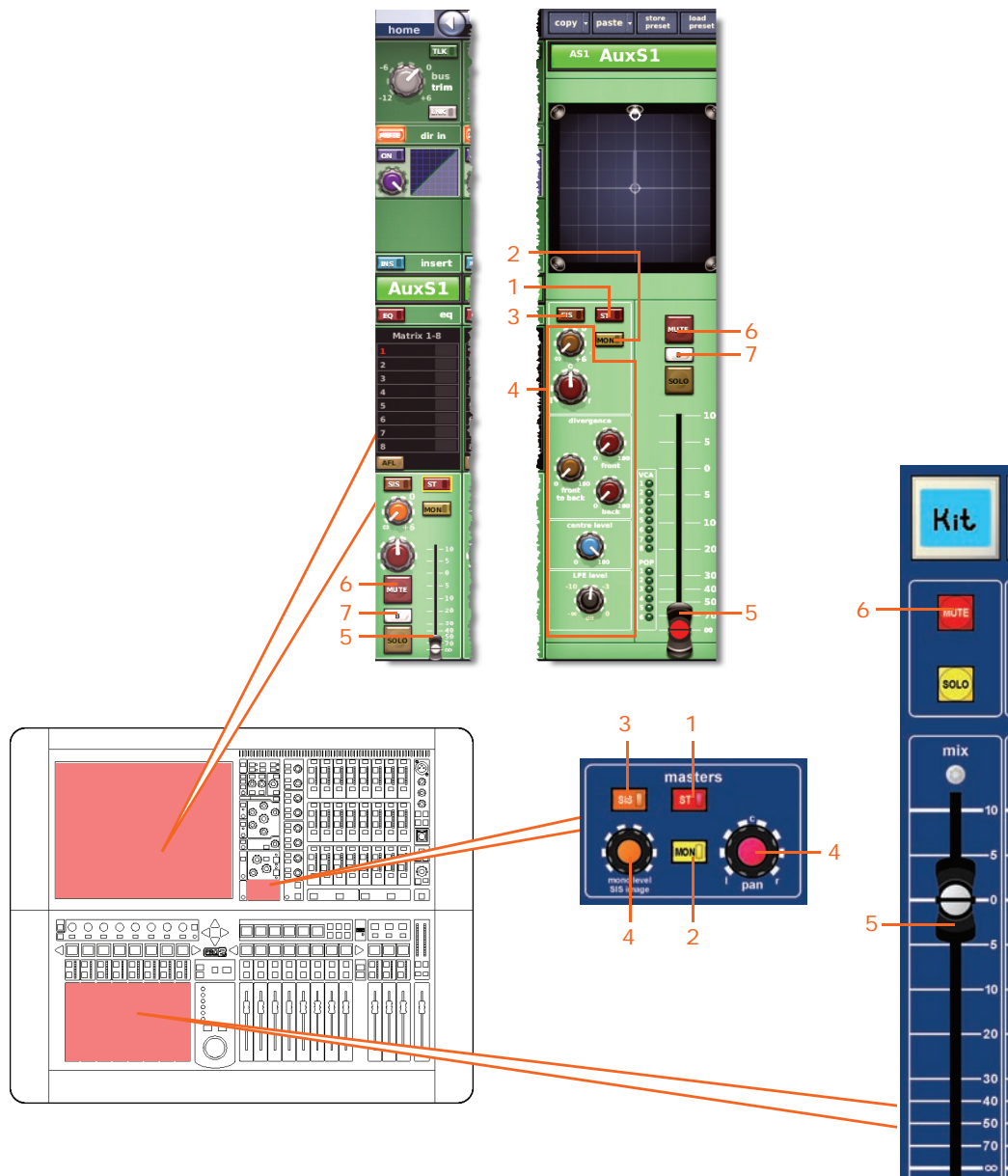

Item	Control	Parameter
1	ST switch	Stereo on/off
2	MON switch	Mono on/off
3	SIS switch	Spatial imaging system on/off
4	Panning control knobs	Surround panning (includes all surround sound parameters)
5	Fader	Level
6	MUTE switch	Mute on/off
7	SOLO B/[B] switch	Solo B on/off

## Return

This section shows you which return channel parameters are affected by copy and paste.

## Configuration

The following diagrams show the configuration parameters affected by copy and paste.

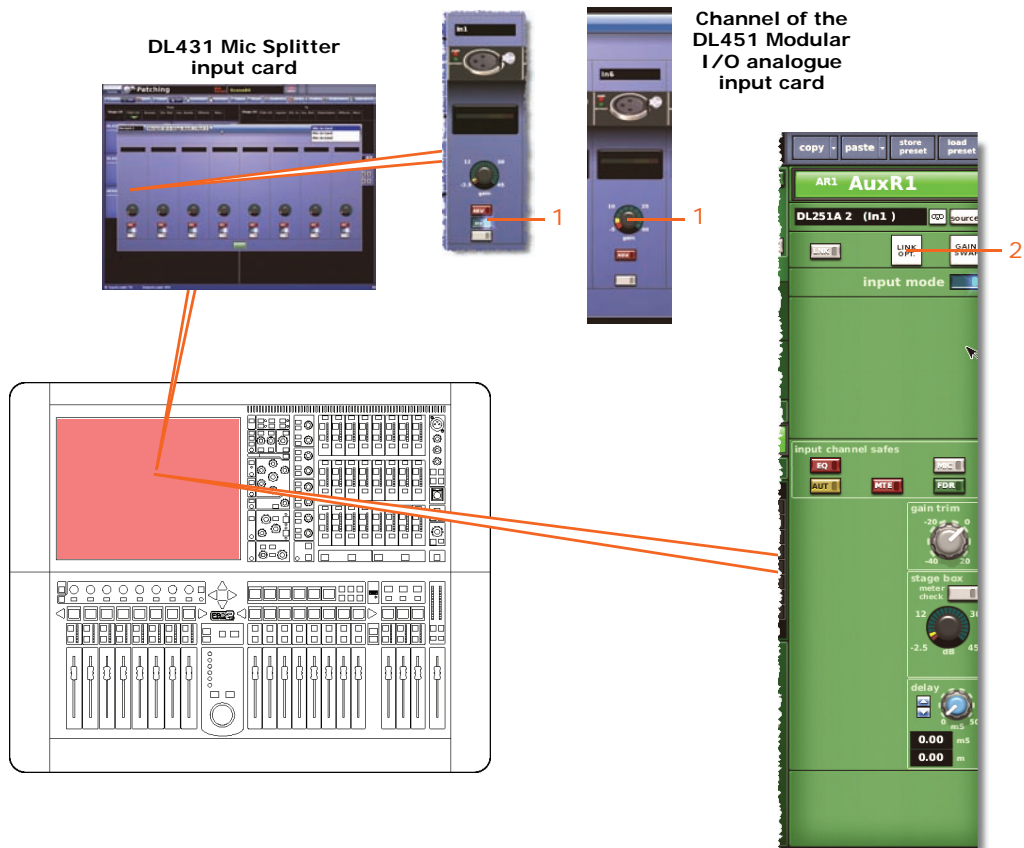

Item	Control	Parameter
1	Stage box control knob	Gain of remote amplifier
2	st. linking options button	Stereo linking options

## Compressor

Not applicable.

## Gate

Not applicable.

## EQ

Not applicable.



## Bus sends

This section shows the return parameters of the mix sections affected by copy and paste.

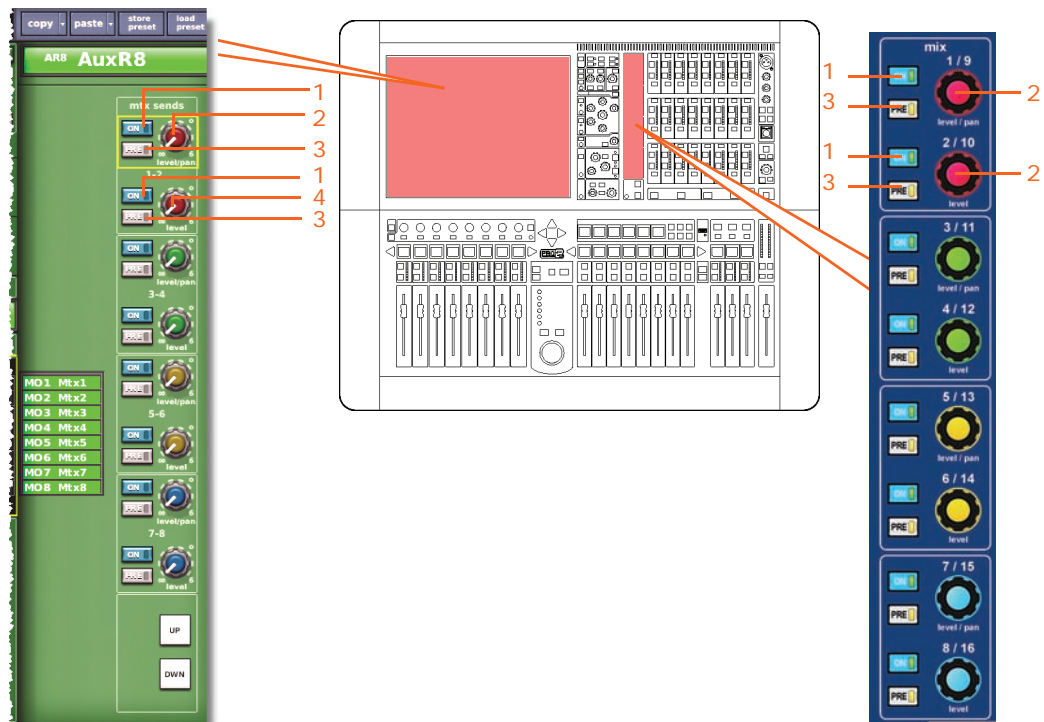

**Note:** Although only matrix sends 1-2 are referenced above, this applies to all 16 matrix sends.

Item	Control	Parameter
1	ON switch	Matrix bus send on/off
2	level/pan control knob	Bus level, or pan when bus is linked
3	PRE switch	Pre-fader on/off
4	level control knob	Bus level

Master routing

This section shows all the parameters of the master routing affected by copy and paste.

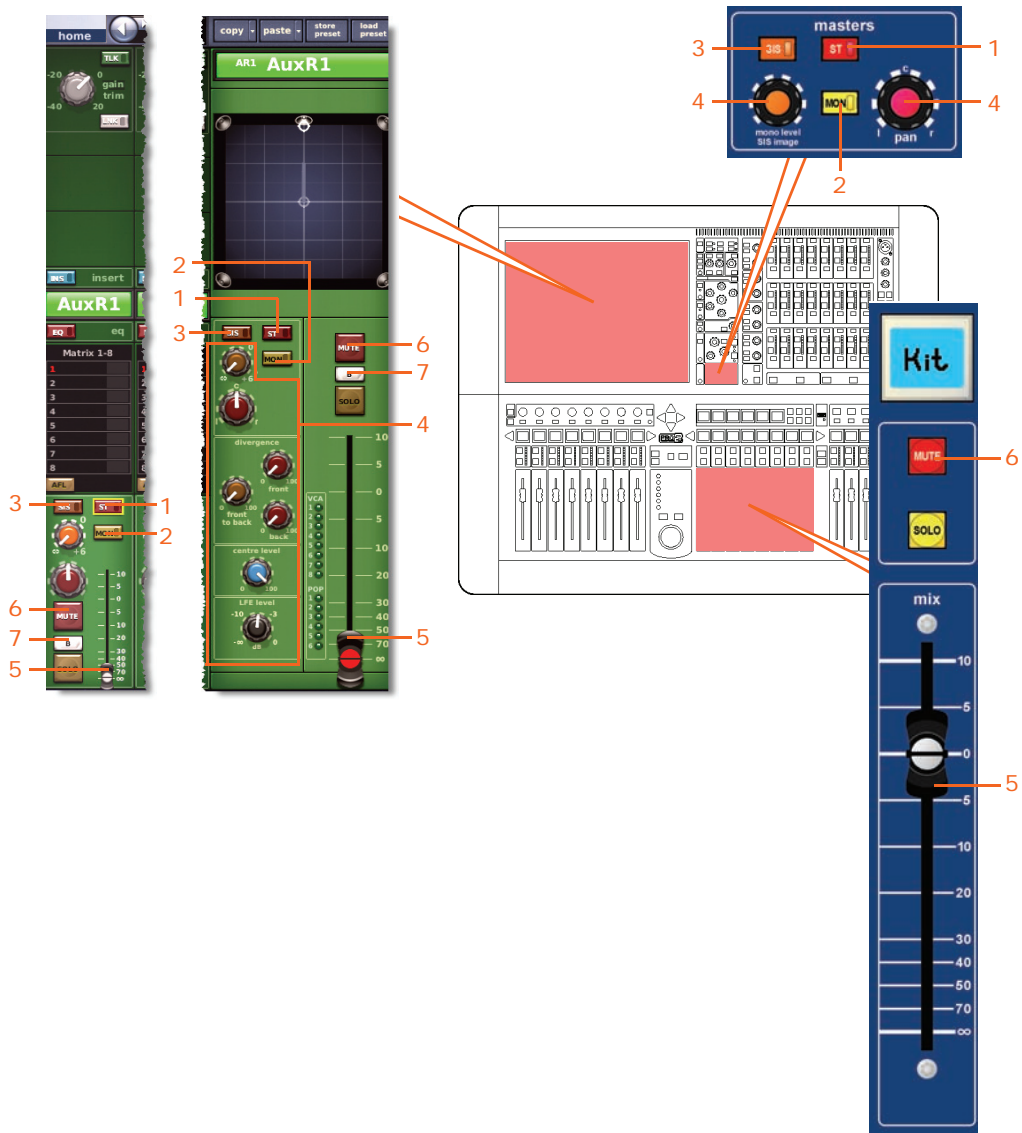

Item	Control	Parameter
1	ST switch	Stereo on/off
2	MON switch	Mono on/off
3	SIS switch	Spatial imaging system on/off
4	Panning control knobs	Surround panning (includes all surround sound parameters)
5	Fader	Level
6	MUTE switch	Mute on/off
7	SOLO B/[B] switch	Solo B on/off

# Matrix

This section shows you which matrix channel parameters are affected by copy and paste.

## Configuration

The following diagram shows the configuration parameters affected by copy and paste.

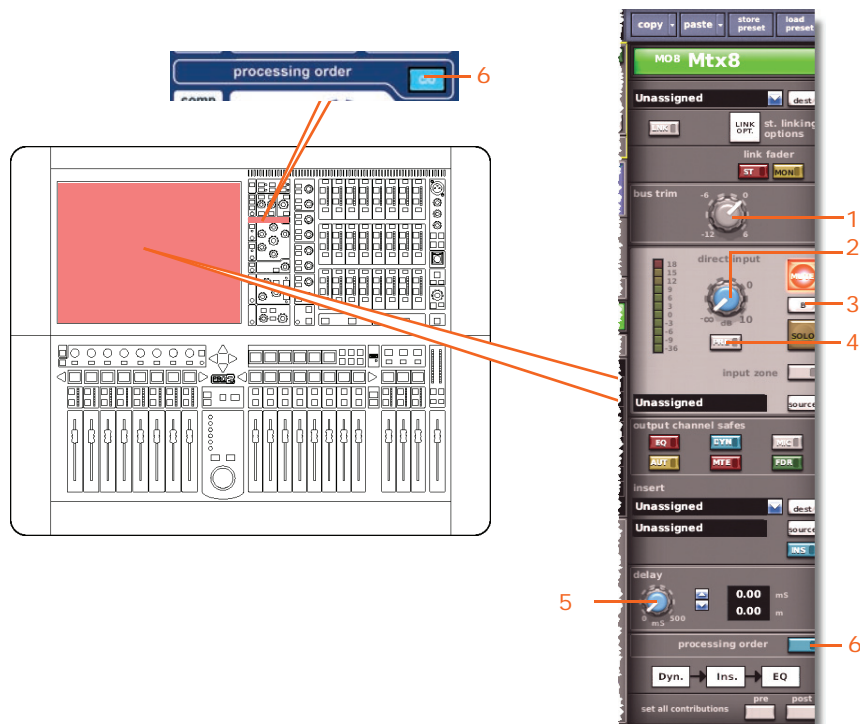

Item	Control	Parameter
1	bus trim control knob	Bus trim level
2	level control knob	Direct input level
3	SOLO B/[B] switch	Direct input solo B on/off
4	MODE/[PRE] switch	Direct input pre- in/out
5	delay control knob	Delay time
6	C/O switch	Order of processing: <b>Dyn.</b> → <b>Ins.</b> → <b>EQ</b> or <b>EQ</b> → <b>Ins.</b> → <b>Dyn.</b>

Compressor

This section shows all the compression parameters of the dynamics section affected by copy and paste. Only corrective compressor shown below, but this is typically the same for the other compressor modes.

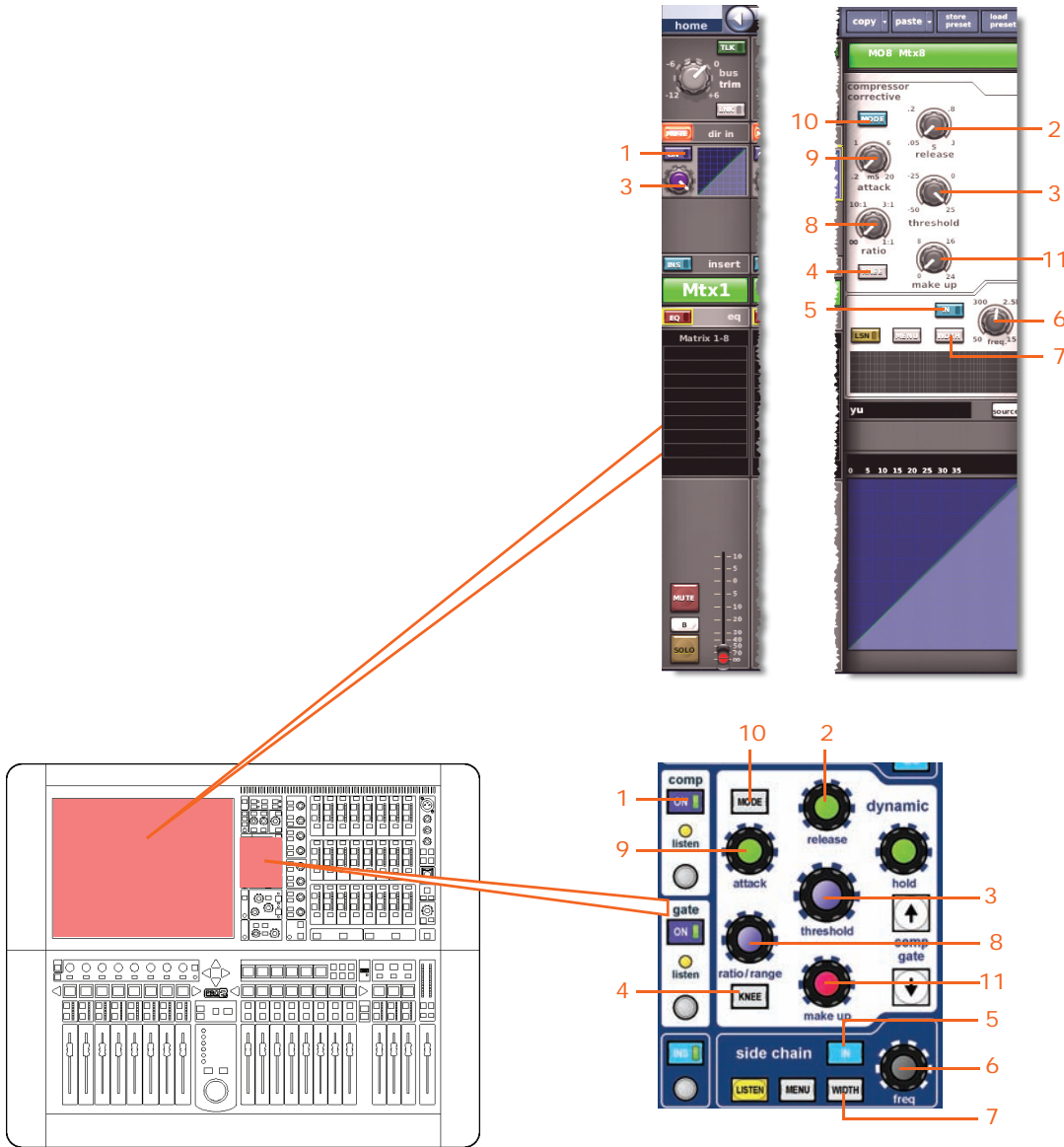

Item	Control	Parameter
1	ON switch	Compressor on/off
2	release control knob	Compressor release
3	threshold control knob	Compressor threshold
4	KNEE pushbutton	Compressor knee: hard, medium or soft
5	IN switch	Compressor sidechain in/out
6	freq control knob	Compressor sidechain frequency

---

<i>Item</i>	<i>Control</i>	<i>Parameter</i>
7	<b>WIDTH</b> pushbutton	Compressor sidechain width: 2 Oct, 1 Oct or 0.3 Oct
8	<b>ratio</b> control knob	Compressor ratio
9	<b>attack</b> control knob	Compressor attack
10	<b>MODE</b> pushbutton	Compressor mode: corrective, adaptive, creative, vintage or shimmer
11	<b>make up</b> control knob	Compressor gain

---

**Gate**

Not applicable.

EQ (GEO)

This section shows all the parameters of the EQ section (including the GEO where appropriate) affected by copy and paste.

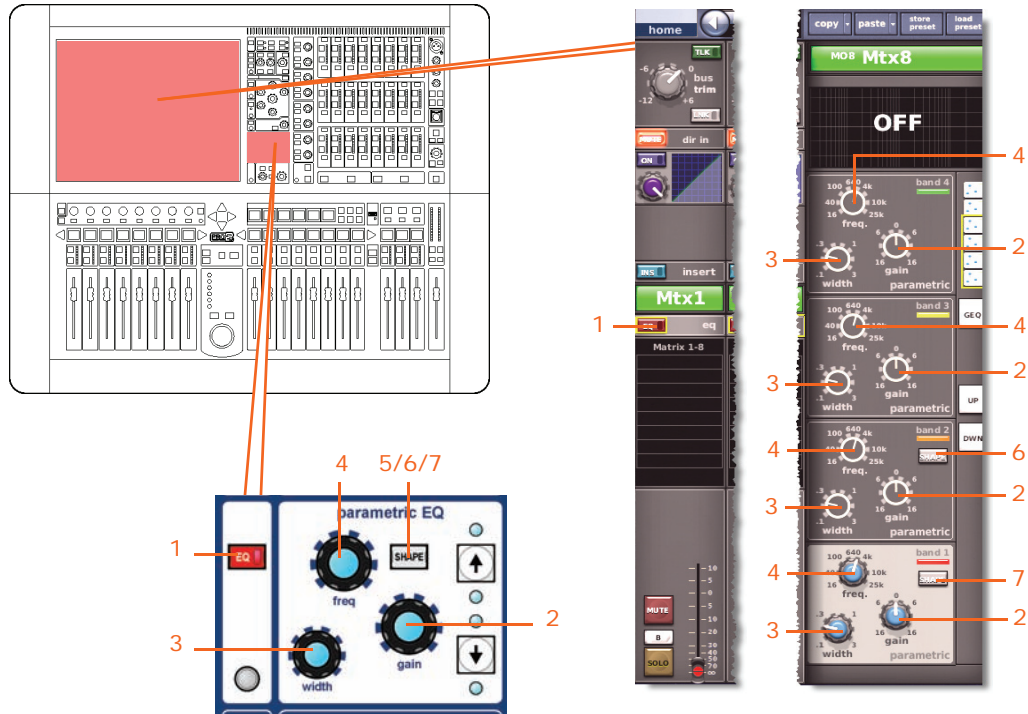

Item	Control	Parameter
1	EQ switch	EQ on/off
2	gain control knob	EQ gain level
3	width control knob	EQ width
4	freq control knob	EQ frequency
5	SHAPE switch	Band 6 shelving mode: bell, soft, low pass 6dB or low pass 12dB
6*	SHAPE switch	Band 2 shelving mode: bell or high pass 24dB
7*	SHAPE switch	Band 1 shelving mode: bell, warm, high pass 6dB or high pass 12dB

\* Not shown in diagram.

**Note:** Although bands 1 and 2 are not shown above, the items in the table also apply. Both bands have items 2, 3 and 4. Band 1 also has item 7, and band 2 also has item 6.

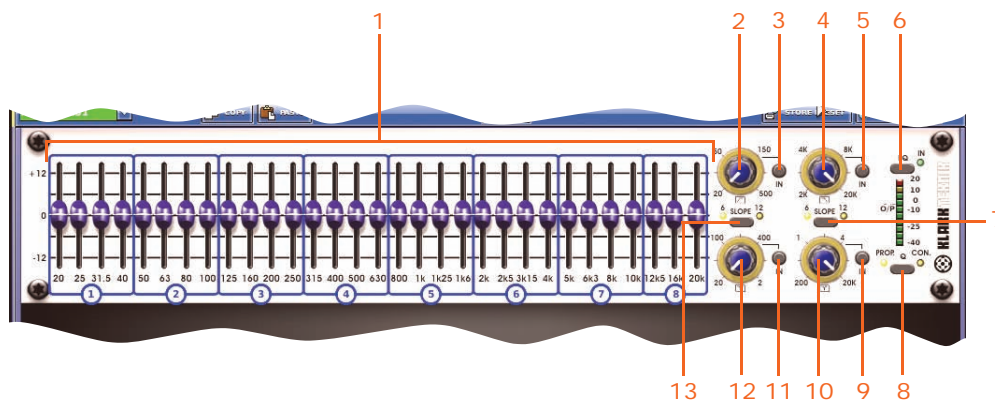

<i>Item</i>	<i>Control</i>	<i>Parameter</i>
1	31 faders	Fader positions
2	High pass filter control knob	High pass filter cut off frequency
3	<b>IN</b> switch	High pass filter in/out
4	Low pass filter control knob	Low pass filter cut off frequency
5	<b>IN</b> switch	Low pass filter in/out
6	<b>EQ</b> switch	EQ in/out
7	<b>SLOPE</b> switch	Low pass filter: 6dB or 12dB
8	<b>Q</b> switch	Q mode as proportional ( <b>PROP.</b> ) or constant ( <b>CON.</b> )
9	<b>IN</b> switch	200Hz - 20kHz notch filter in/out
10	Notch filter control knob	200Hz - 20kHz notch filter frequency
11	<b>IN</b> switch	20Hz - 2kHz notch filter in/out
12	Notch filter control knob	20Hz - 2kHz notch filter frequency
13	<b>SLOPE</b> switch	High pass filter: 6dB or 12dB

**Bus sends**

Not applicable.

Fader section

This section shows all the parameters of the master routing affected by copy and paste.

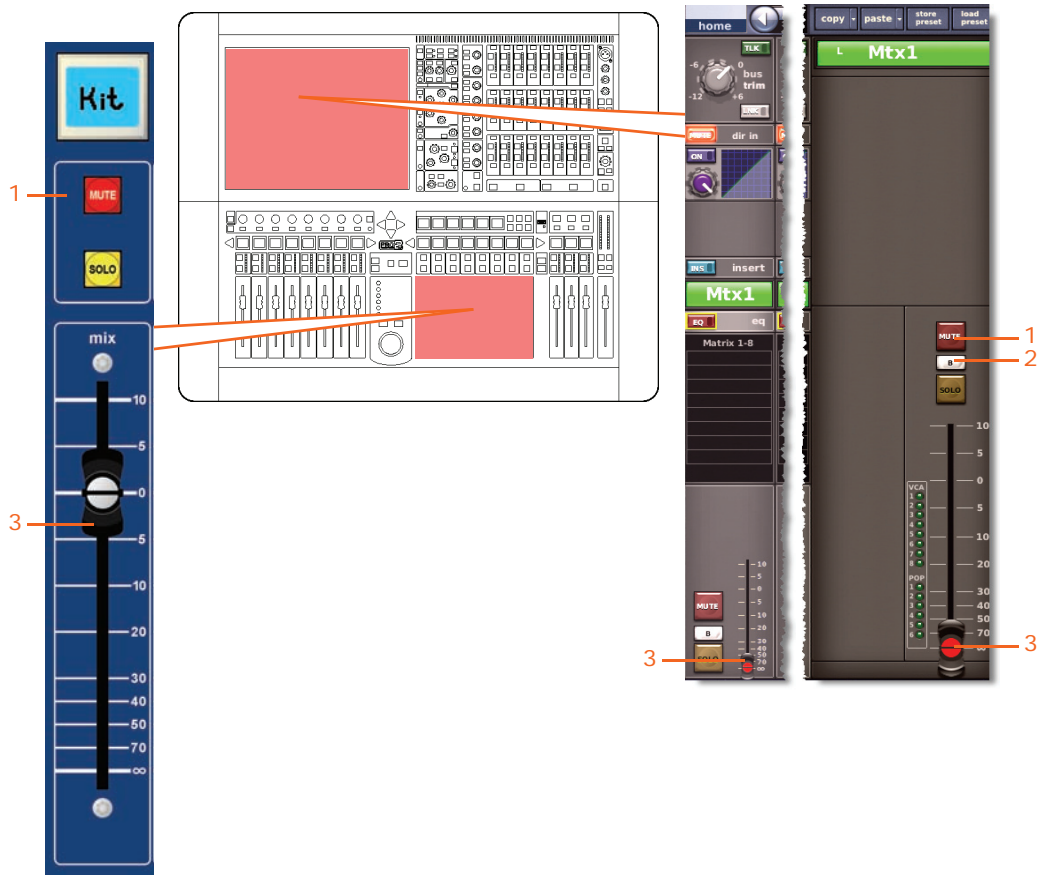

<i>Item</i>	<i>Control</i>	<i>Parameter</i>
1	MUTE switch	Mute on/off
2	SOLO B/[B] switch	Solo B on/off
3	Fader	Level



## Master

This section shows you which master channel parameters are affected by copy and paste.

### Configuration

The following diagrams show the configuration parameters affected by copy and paste.

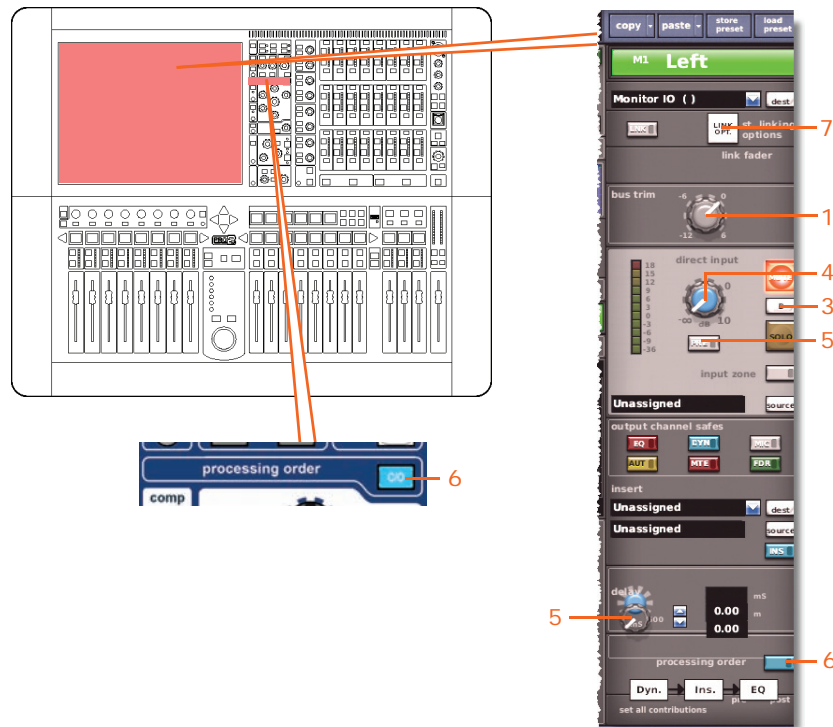

Item	Control	Parameter
1	bus trim control knob	Bus trim level
2	level control knob	Direct input level
3	SOLO B/[B] switch	Direct input solo B on/off
4	MODE/[PRE] switch	Direct input pre- in/out
5	delay control knob	Delay level
6	C/O switch	Order of processing: <b>Dyn.</b> → <b>Ins.</b> → <b>EQ</b> or <b>EQ</b> → <b>Ins.</b> → <b>Dyn.</b>
7	st. linking options button	Stereo linking options

Compressor

This section shows the compression parameters of the dynamics section affected by copy and paste. Only corrective compressor shown below, but typically the same for the other compressor modes.

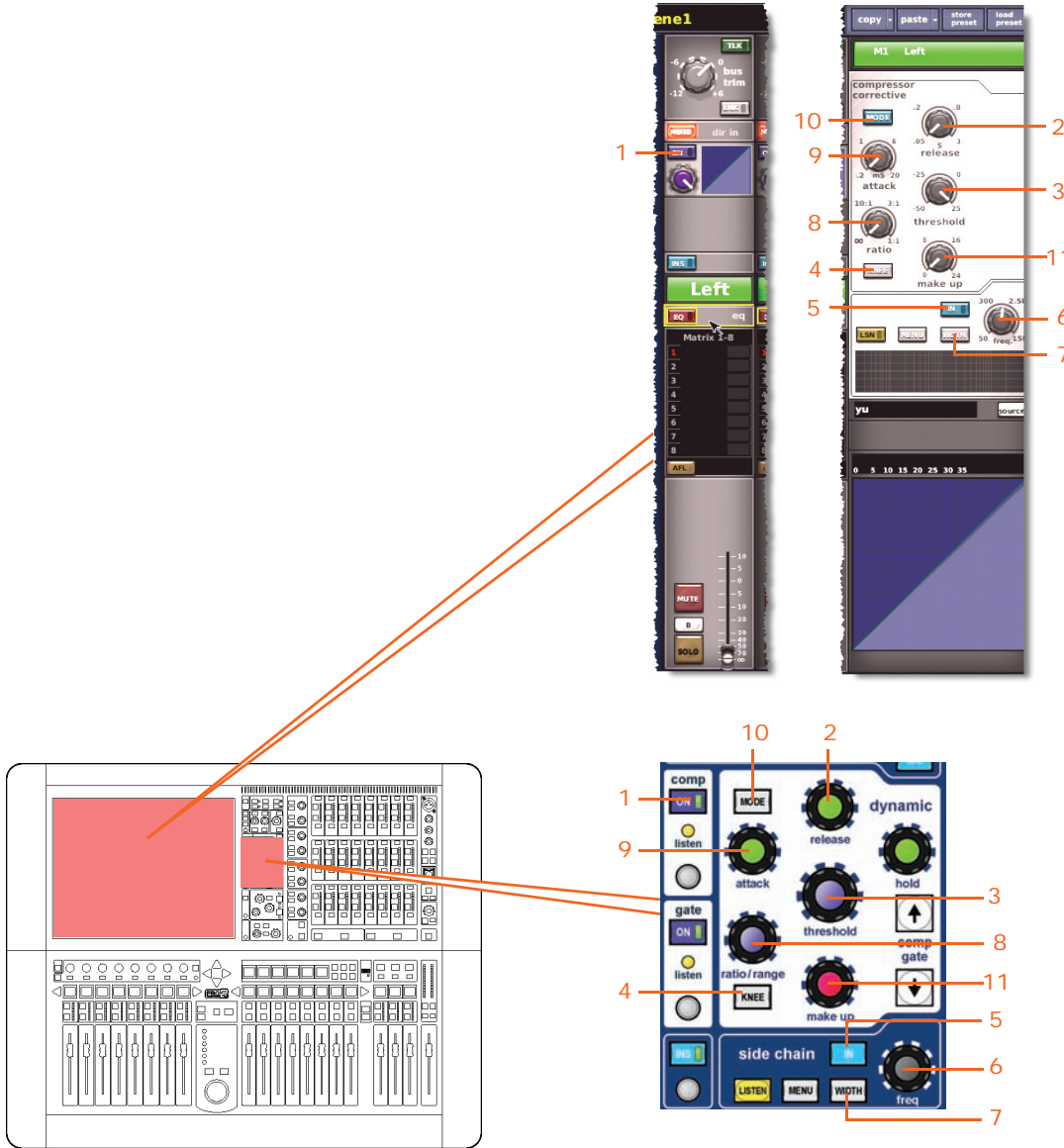

Item	Control	Parameter
1	ON switch	Compressor on/off
2	release control knob	Compressor release
3	threshold control knob	Compressor threshold
4	KNEE pushbutton	Compressor knee: hard, medium or soft
5	IN switch	Compressor sidechain in/out
6	freq control knob	Compressor sidechain frequency
7	WIDTH pushbutton	Compressor sidechain width: 2 Oct, 1 Oct or 0.3 Oct

---

<i>Item</i>	<i>Control</i>	<i>Parameter</i>
8	<b>ratio</b> control knob	Compressor ratio
9	<b>attack</b> control knob	Compressor attack
10	<b>MODE</b> pushbutton	Compressor mode: corrective, adaptive, creative, vintage or shimmer
11	<b>make up</b> control knob	Compressor gain

---

**Gate**

Not applicable.

EQ (GEO)

This section shows all the parameters of the EQ section (including the GEO where appropriate) affected by copy and paste.

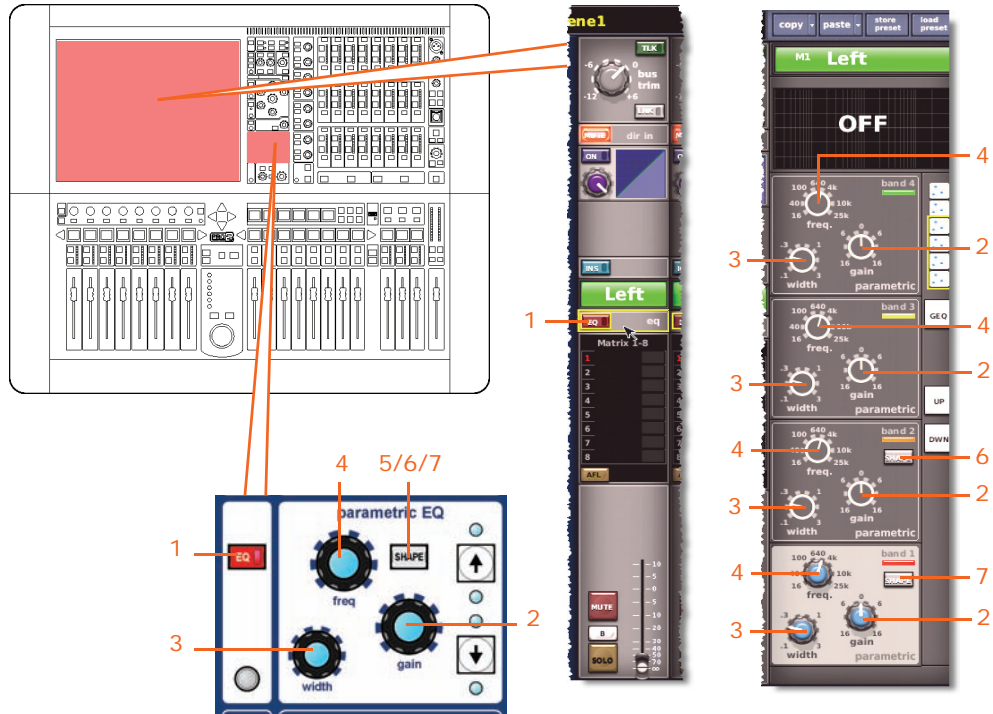

Item	Control	Parameter
1	EQ switch	EQ on/off
2	gain control knob	EQ gain level
3	width control knob	EQ width
4	freq control knob	EQ frequency
5	SHAPE switch	Band 6 shelving mode: bell, soft, low pass 6dB or low pass 12dB
6*	SHAPE switch	Band 2 shelving mode: bell or high pass 24dB
7*	SHAPE switch	Band 1 shelving mode: bell, warm, high pass 6dB or high pass 12dB

\* Not shown in diagram.

**Note:** Although bands 1 and 2 are not shown above, the items in the table also apply. Both bands have items 2, 3 and 4. Band 1 also has item 7, and band 2 also has item 6.

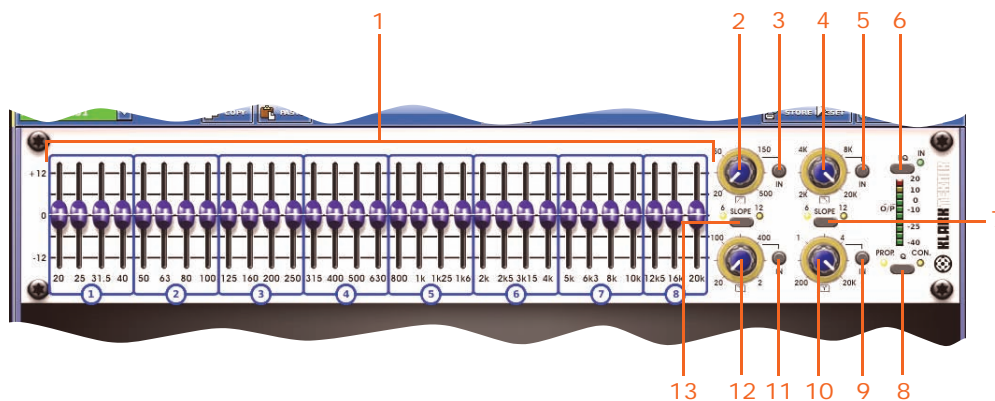

<i>Item</i>	<i>Control</i>	<i>Parameter</i>
1	31 faders	Fader positions
2	High pass filter control knob	High pass filter cut off frequency
3	<b>IN</b> switch	High pass filter in/out
4	Low pass filter control knob	Low pass filter cut off frequency
5	<b>IN</b> switch	Low pass filter in/out
6	<b>EQ</b> switch	EQ in/out
7	<b>SLOPE</b> switch	Low pass filter: 6dB or 12dB
8	<b>Q</b> switch	Q mode as proportional ( <b>PROP.</b> ) or constant ( <b>CON.</b> )
9	<b>IN</b> switch	200Hz - 20kHz notch filter in/out
10	Notch filter control knob	200Hz - 20kHz notch filter frequency
11	<b>IN</b> switch	20Hz - 2kHz notch filter in/out
12	Notch filter control knob	20Hz - 2kHz notch filter frequency
13	<b>SLOPE</b> switch	High pass filter: 6dB or 12dB

**Bus sends**

Not applicable.

Master routing

This section shows all the parameters of the master routing affected by copy and paste.

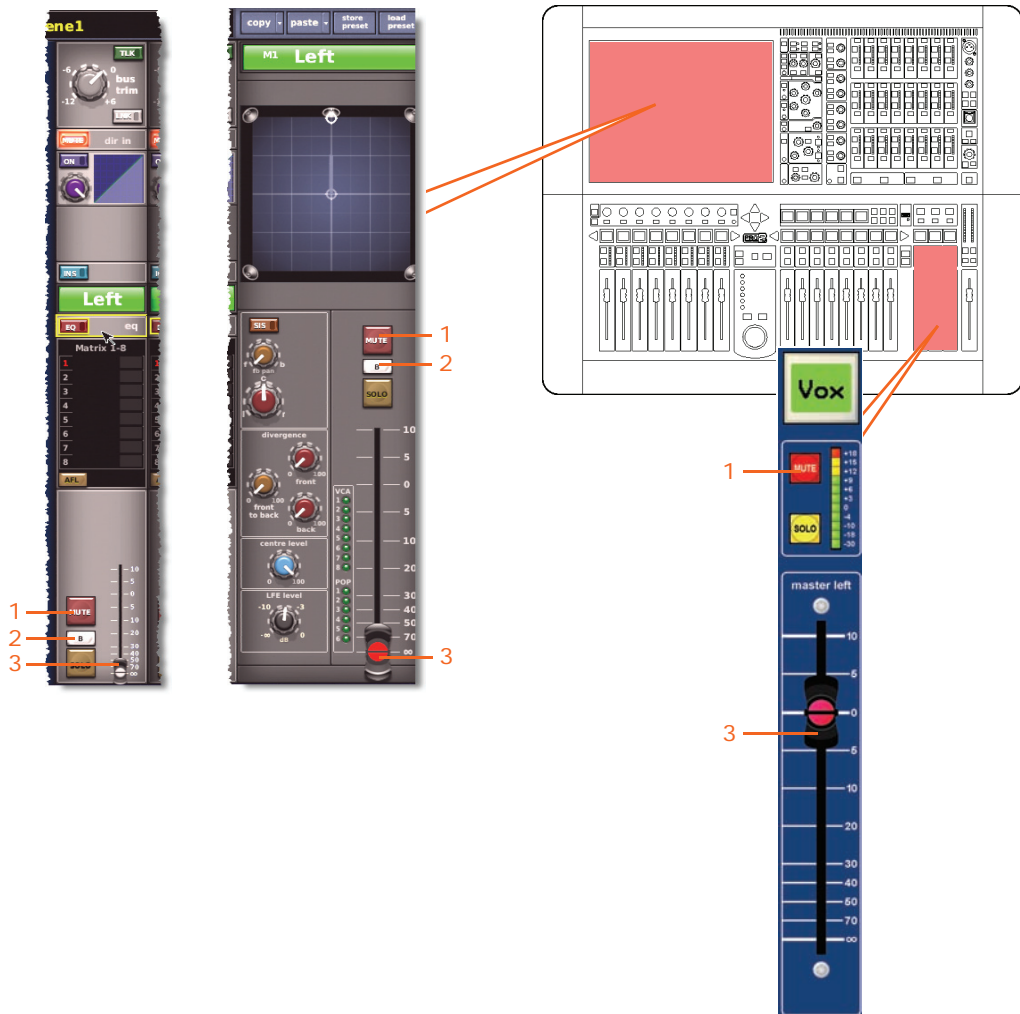

<i>Item</i>	<i>Control</i>	<i>Parameter</i>
1	MUTE switch	Mute on/off
2	SOLO B/[B] switch	Solo B on/off
3	Fader	Level

## Appendix J: Parameters Affected By Stereo Linking

This appendix shows the parameters that are linked per option (selectable globally and per pair).

### Overview

The following table shows which parameters are copied across the channels per control area.

**Table 17: Reference to stereo linking sections**

<i>Control area</i>	<i>Input Channels</i>	<i>Aux Returns (Returns)</i>	<i>Aux Sends (Auxes)</i>	<i>Matrix (Matrices)</i>	<i>Masters</i>
<b>Input Controls</b>	See page 462	See page 474	See page 482	See page 492	See page 500
<b>Direct Output</b>	See page 463	N/A	N/A	N/A	N/A
<b>Direct Input</b>	N/A	N/A	See page 483	See page 493	See page 501
<b>Filters</b>	See page 464	N/A	N/A	N/A	N/A
<b>Dynamics</b>	See page 465	N/A	See page 484	See page 494	See page 502
<b>Insert</b>	See page 467	See page 475	See page 485	See page 495	See page 503
<b>EQ</b>	See page 468	See page 476	See page 486	See page 496	See page 504
<b>Bus Sends</b>	See page 469	See page 477	See page 487	N/A	See page 505
<b>Master Routing</b>	See page 470	See page 478	See page 488	N/A	See page 506
<b>Fader</b>	See page 471	See page 479	See page 489	See page 497	See page 507
<b>Delay</b>	See page 472	See page 480	See page 490	See page 498	See page 508
<b>Mute</b>	See page 473	See page 481	See page 491	See page 499	See page 509

## Input Channels

This section shows the linked parameters of the input channels.

### Input controls

The following diagram shows the input control parameters that are linked across the channel pair.

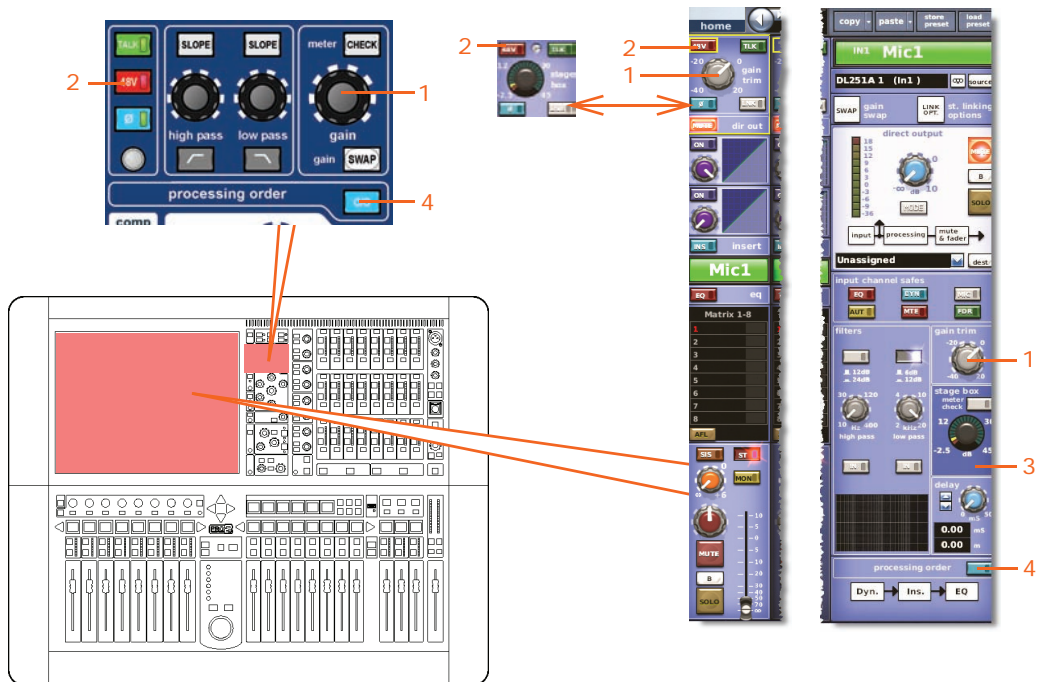

Item	Control	Parameter
1	gain trim control knob	Digital trim level
2	48V switch*	48V phantom voltage on/off
3	30Hz switch	30Hz filter in/out
4	C/O switch*	Order of processing: <b>Dyn.</b> → <b>Ins.</b> → <b>EQ</b> or <b>EQ</b> → <b>Ins.</b> → <b>Dyn.</b>

\* Apply to tape and primary inputs.



**Direct output**

The following diagram shows the direct output control parameters that are linked across the channel pair.

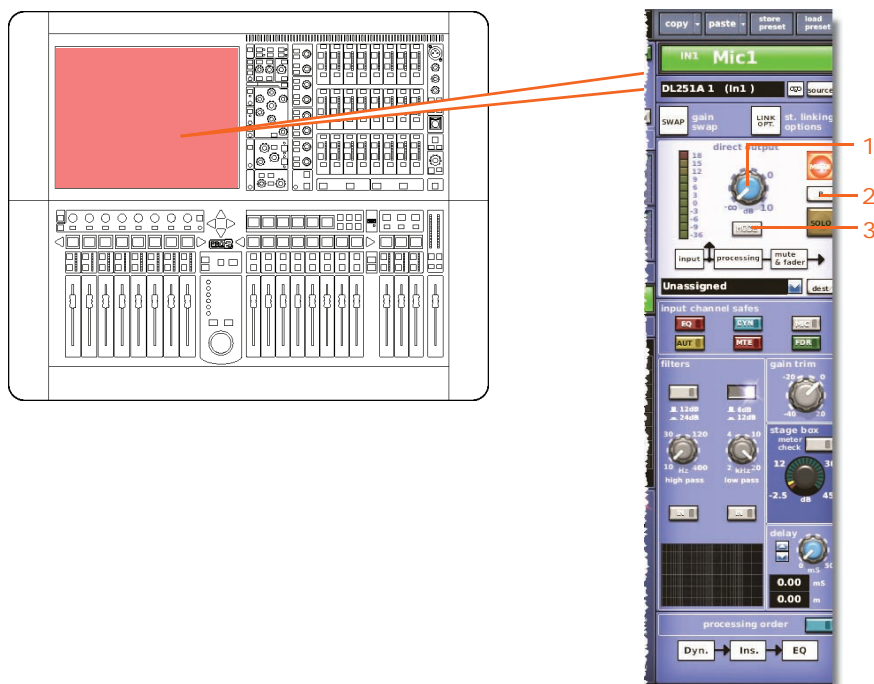

<i>Item</i>	<i>Control</i>	<i>Parameter</i>
1	level control knob	Direct output level
2	SOLO B/[B] control knob	Direct output solo B in/out
3	MODE pushbutton	Direct output tap-off point: "Post-fade and mute", "Pre-mute, pre-processing" or "Pre-mute, post-processing"

**Direct input**

Not applicable.

Filters

This section shows the parameters of the filters section affected by stereo linking.

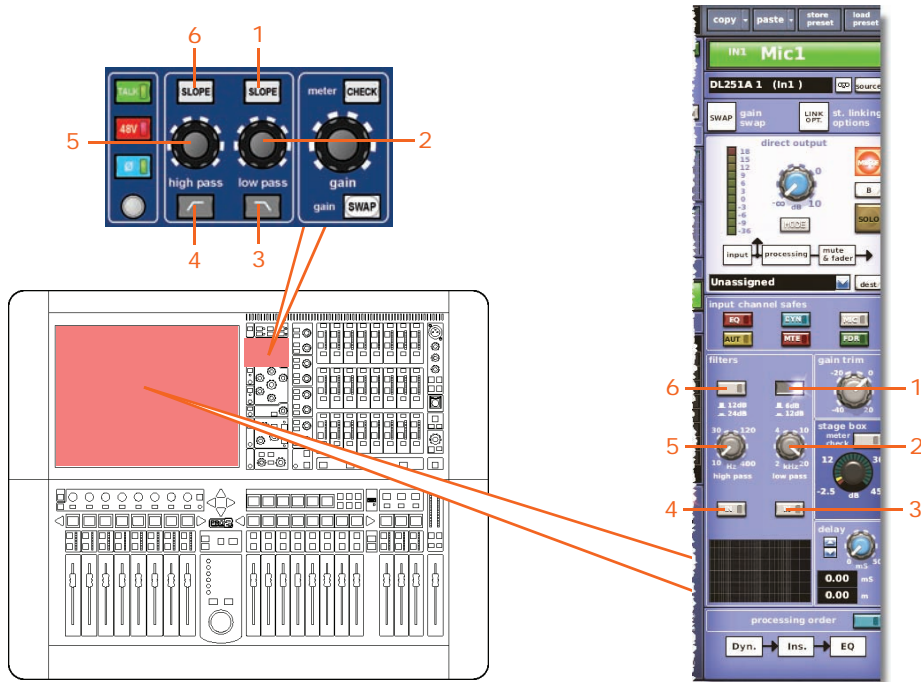

Item	Control	Parameter
1	<b>SLOPE</b> pushbutton	Low pass filter slope 6dB or 12dB
2	<b>low pass</b> control knob	Low pass filter frequency
3	<input type="checkbox"/> /[IN] switch	Low pass filter in/out
4	<input type="checkbox"/> /[IN] switch	High pass filter in/out
5	<b>high pass</b> control knob	High pass filter frequency
6	<b>SLOPE</b> pushbutton	High pass filter slope 12dB or 24dB

Dynamics

This section shows the compressor and gate parameters of the dynamics area affected by stereo linking.

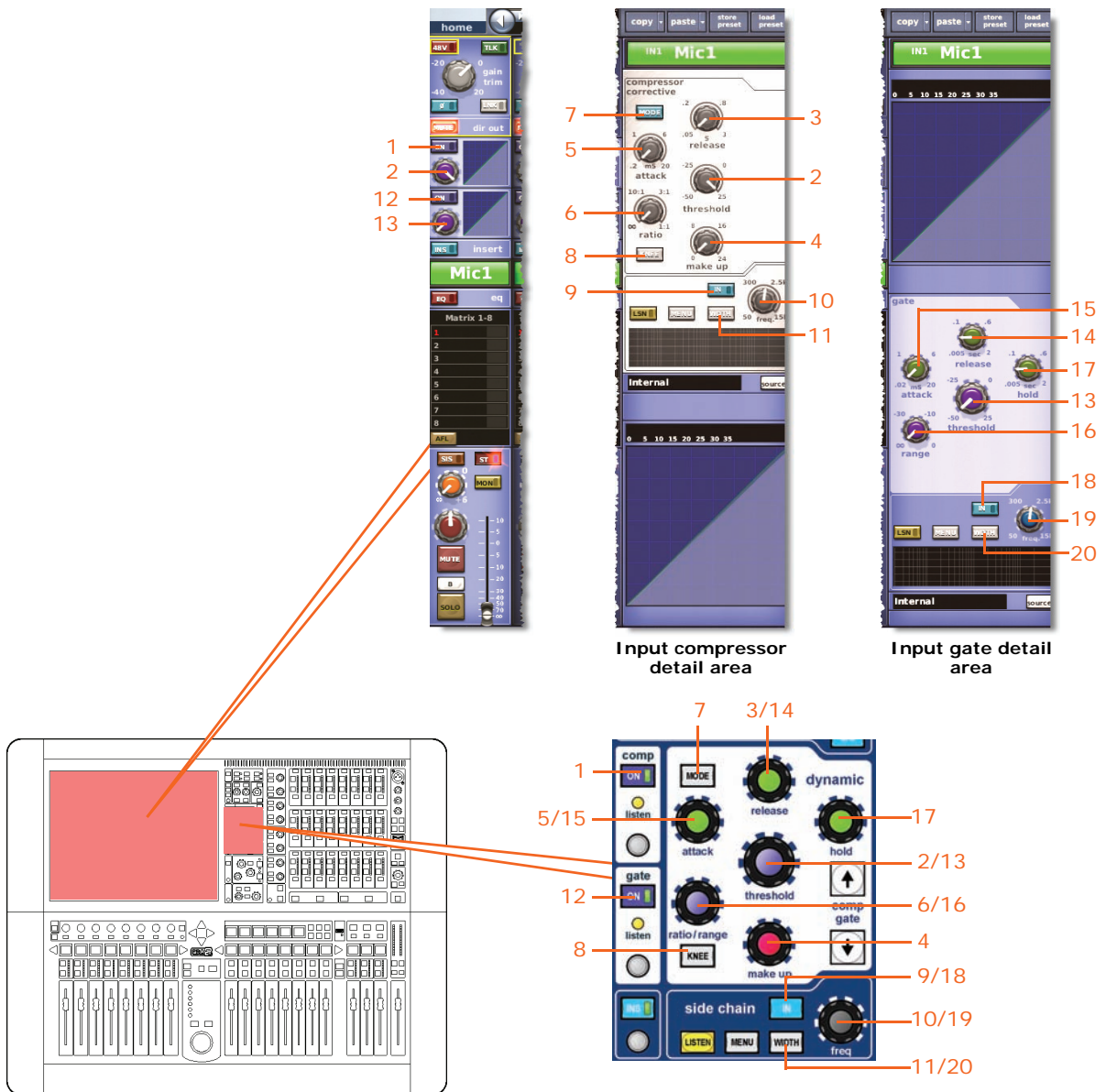

**Note:** Only the corrective compressor is shown above, but this is typically the same for the other compressor modes (adaptive, creative and vintage).

Item	Control	Parameter
1	ON switch	Compressor on/off
2	threshold control knob	Compressor threshold
3	release control knob	Compressor release
4	gain/[make up] control knob	Compressor make up gain

<i>Item</i>	<i>Control</i>	<i>Parameter</i>
5	<b>attack</b> control knob	Compressor attack
6	<b>ratio/range/[ratio]</b> control knob	Compressor ratio
7	<b>MODE</b> pushbutton	Compressor mode: corrective, adaptive, creative or vintage
8	<b>KNEE</b> pushbutton	Compressor knee: hard, medium or soft
9	<b>IN</b> switch	Compressor sidechain in/out
10	<b>freq</b> control knob	Compressor sidechain frequency
11	<b>WIDTH</b> pushbutton	Compressor sidechain width: 2 Oct, 1 Oct or 0.3 Oct
12	<b>ON</b> switch	Gate on/off
13	<b>threshold</b> control knob	Gate threshold
14	<b>release</b> control knob	Gate release
15	<b>attack</b> control knob	Gate attack
16	<b>ratio/range/[range]</b> control knob	Gate range
17	<b>hold</b> control knob	Gate hold
18	<b>IN</b> switch	Gate sidechain in/out
19	<b>freq</b> control knob	Gate sidechain frequency
20	<b>WIDTH</b> pushbutton	Gate sidechain width (unlabelled) selector: 2 Oct, 1 Oct and 0.3 Oct

**Note:** *The compressor and gate sidechains of stereo paired channels are always linked such that they ensure the same amount of gain reduction is applied to both channels.*

Insert

This section shows the parameters of the insert section affected by stereo linking.

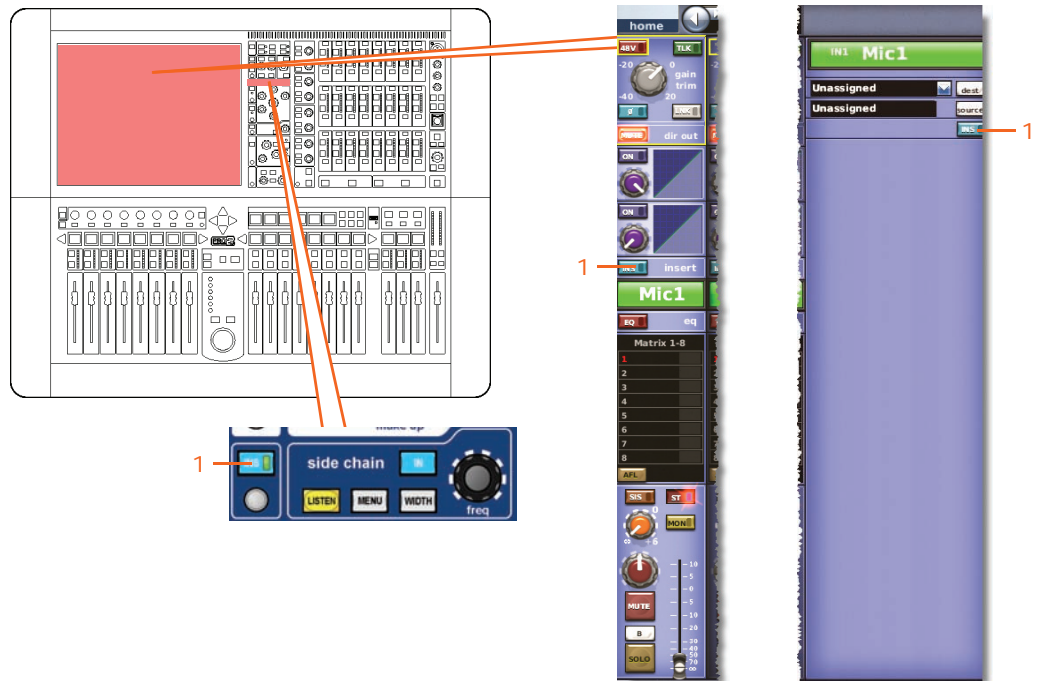

<i>Item</i>	<i>Control</i>	<i>Parameter</i>
1	INS switch	Insert in/out

EQ

The following diagram shows the EQ parameters affected by stereo linking.

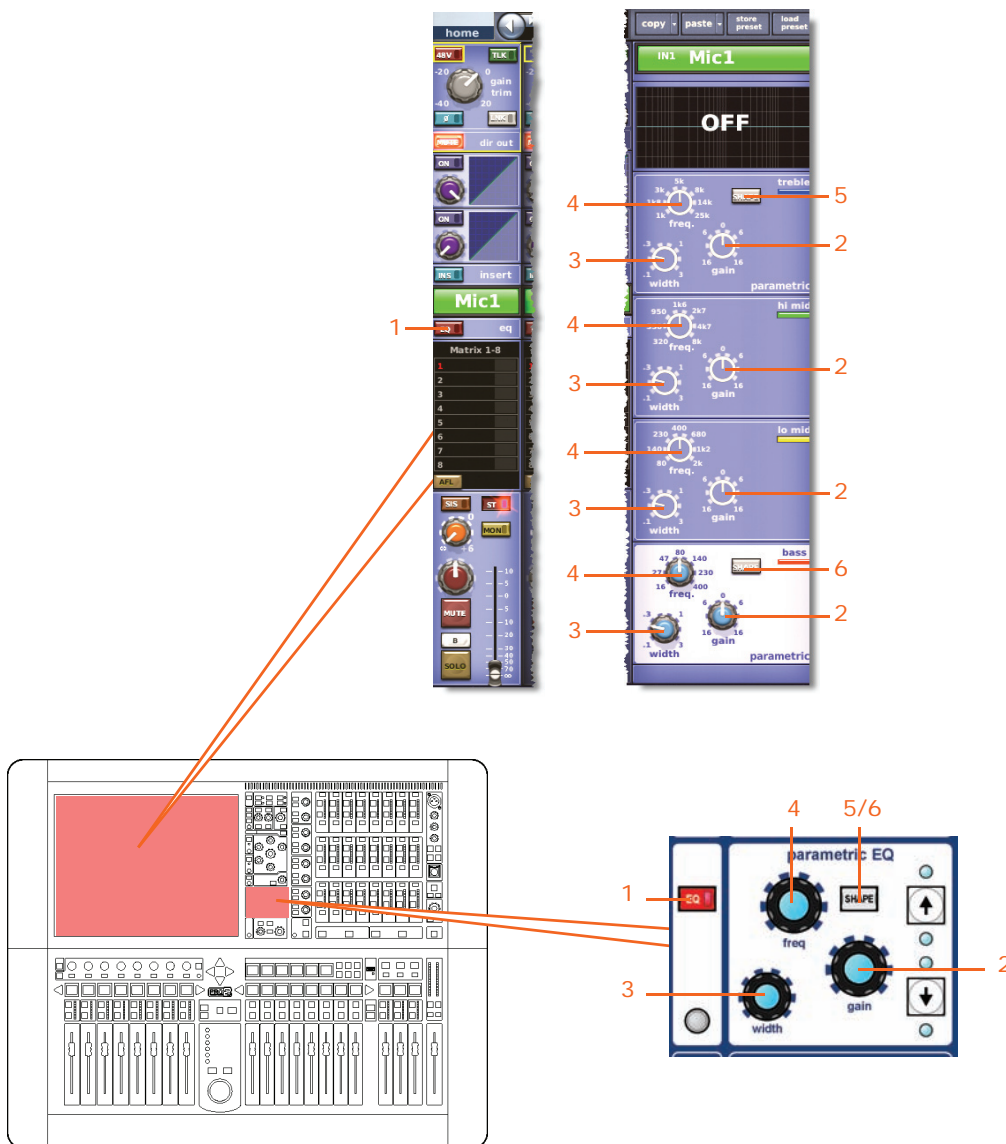

Item	Control	Parameter
1	EQ switch	EQ on/off
2	gain control knob	EQ gain level
3	width control knob	EQ width
4	freq control knob	EQ frequency
5	SHAPE switch	Treble shelving mode: parametric, bright, classic or soft
6	SHAPE switch	Bass shelving mode: parametric, deep, classic or warm

**Bus sends**

The following diagram shows the input bus sends affected by stereo linking, and applies to the 16 auxes and eight matrices.

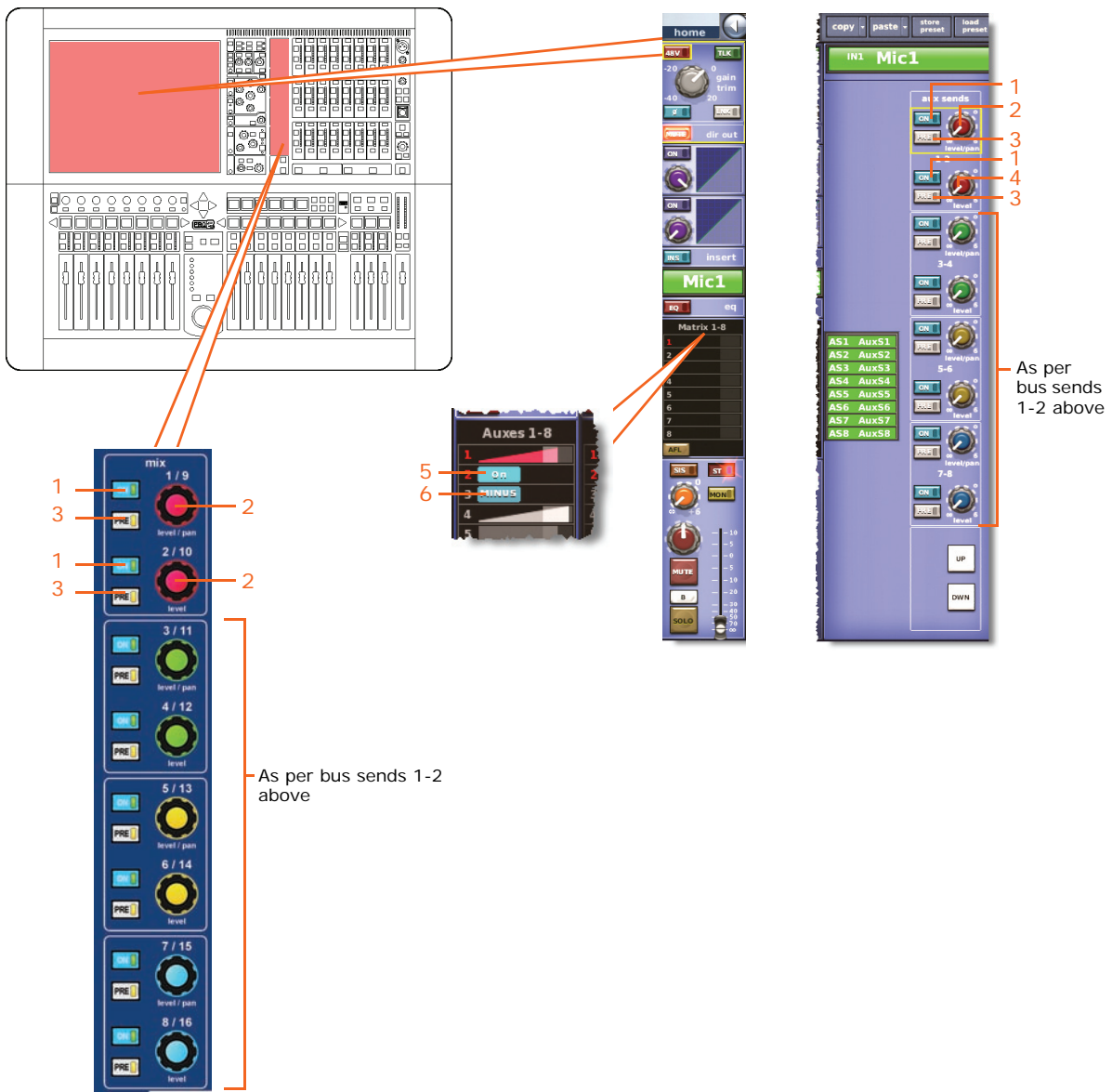

**Note:** Only matrix sends 1 to 8 are shown above, but this is typically the same for all of the bus sends (eight matrices and 16 auxes).

Item	Control	Parameter
1	ON switch	Bus send on/off
2	level/pan control knob	Bus level, or pan when bus is linked. (When sending onto a stereo bus the send pan controls are not linked.)
3	PRE switch	Pre-fader on/off
4	level control knob	Bus level



<i>Item</i>	<i>Control</i>	<i>Parameter</i>
5	On switch	Aux bus send on/off — only available when aux bus is in group mode
6	MINUS switch	Aux bus send mute on/off — only available when aux bus is in mix minus mode

**Master routing**

This section shows the parameters of the master routing affected by stereo linking.

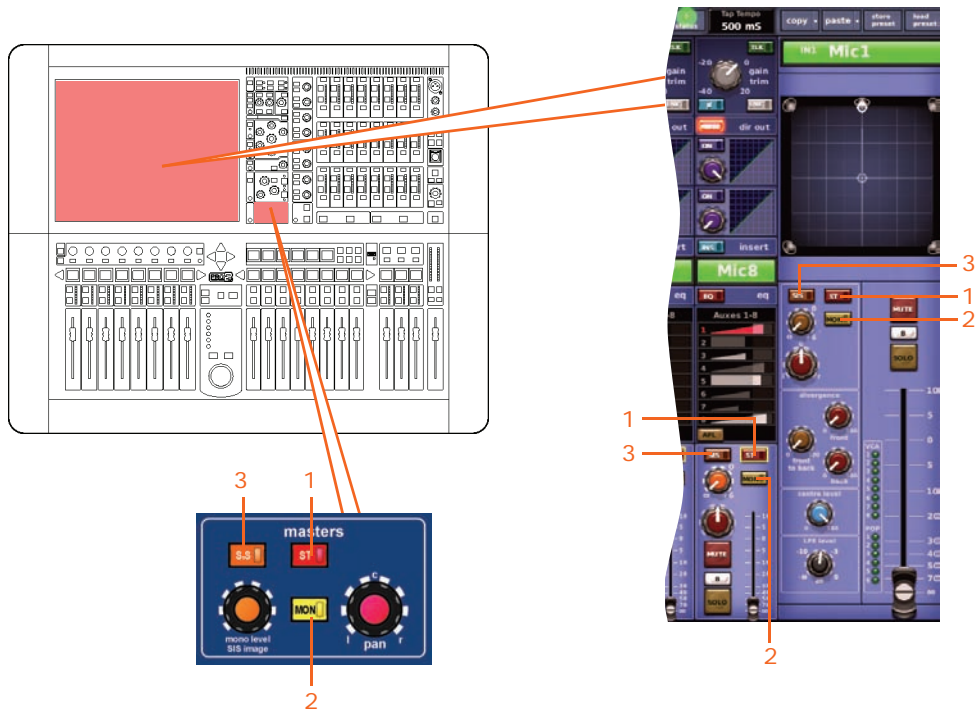

<i>Item</i>	<i>Control</i>	<i>Parameter</i>
1	ST switch	Stereo on/off
2	MON switch	Mono on/off
3	SIS switch	Spatial imaging system on/off



Fader

This section shows the fader parameters affected by stereo linking.

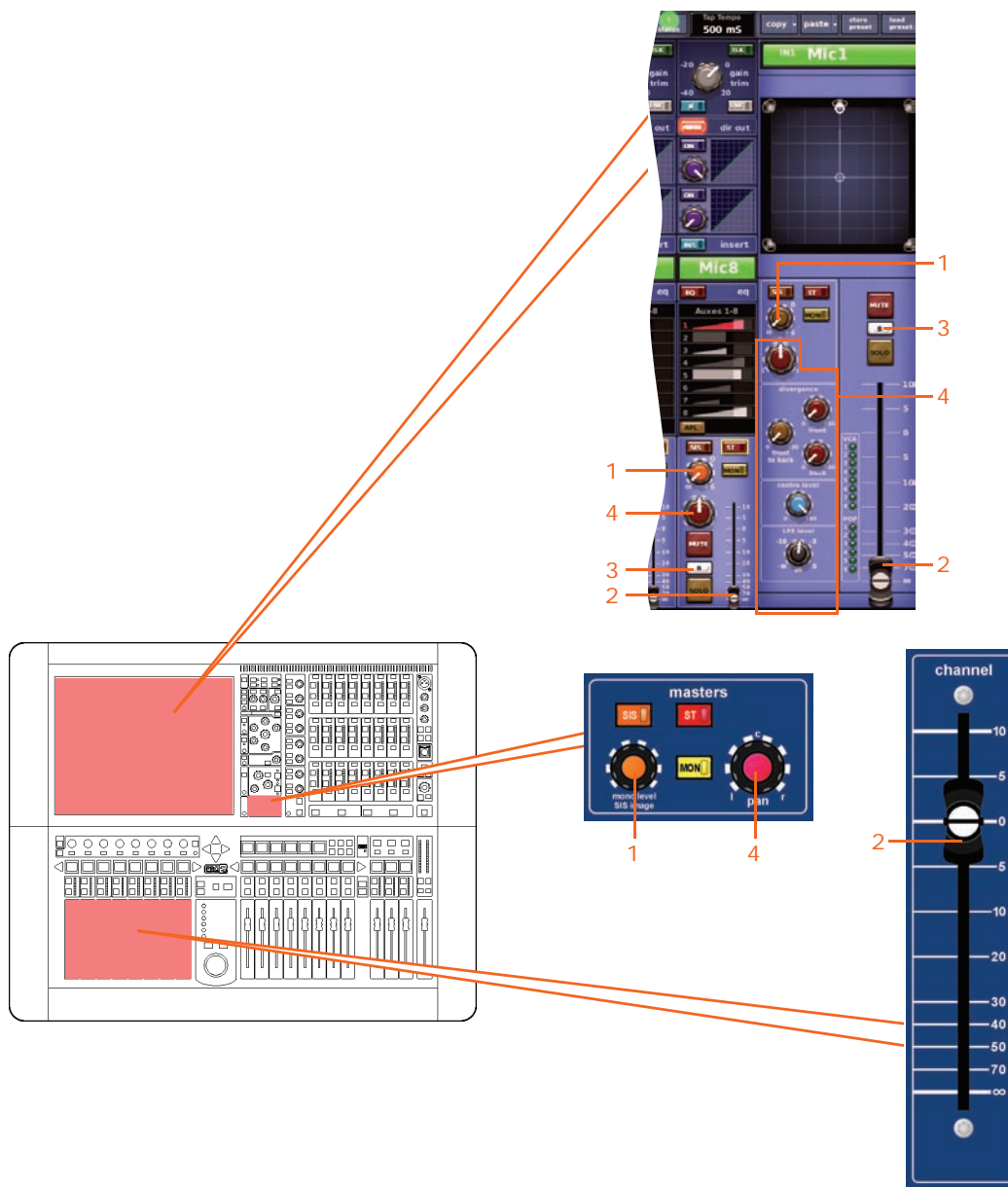

Item	Control	Parameter
1	mono level/SIS image control knob	Mono send level. (Only linked when SIS is out on both channels and surround mode is not selected.)
2	Fader	Fader level
3	SOLO B/[B] control knob	Solo B in/out
4	Panning control knobs	Surround panning, which includes all surround sound parameters, provided <b>Surround Mode</b> is not configured as <b>None</b> (see "Selecting the surround mode" on page 209)

Delay

The following diagram shows the delay parameters affected by stereo linking.

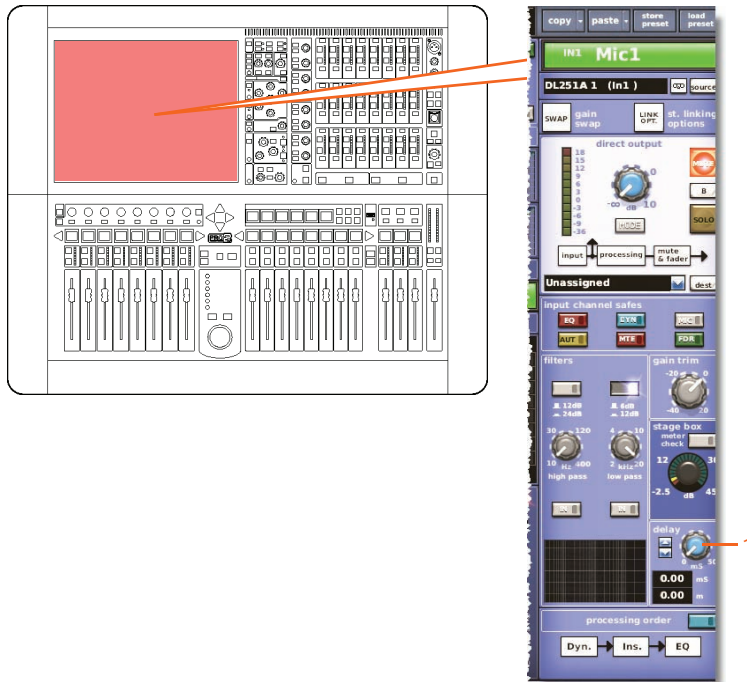

<i>Item</i>	<i>Control</i>	<i>Parameter</i>
1	delay control knob	Delay time

Mute

The following diagram shows the mute parameters affected by stereo linking.

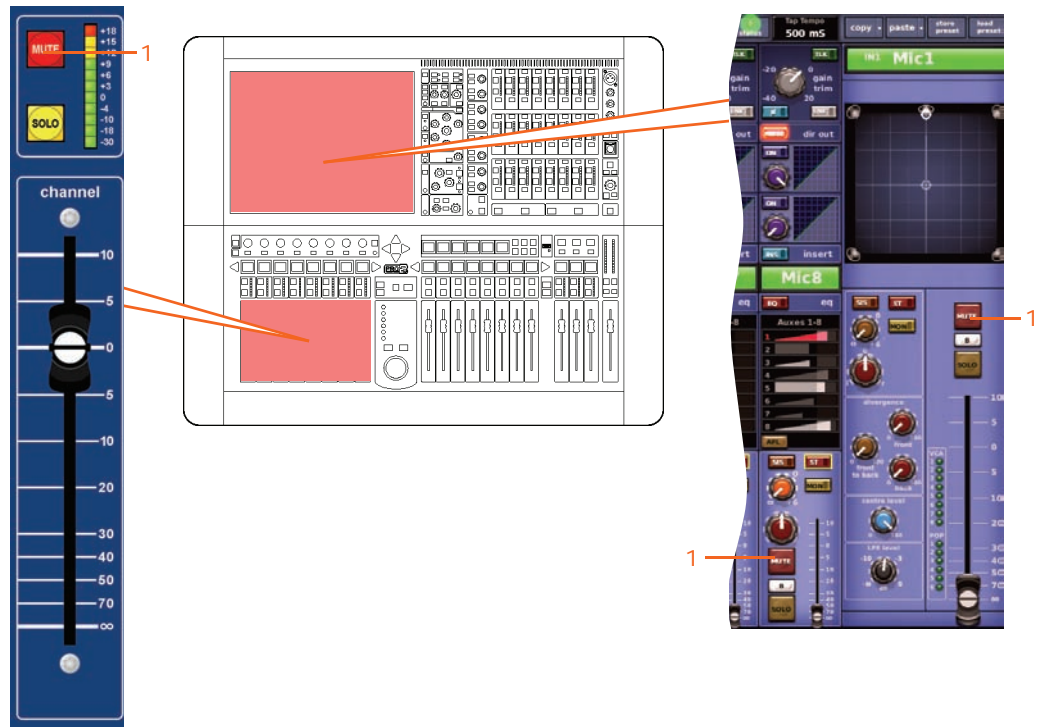

<i>Item</i>	<i>Control</i>	<i>Parameter</i>
1	MUTE button	Mutes the input channel signal

## Aux Returns

This section shows the linked parameters of the return channels.

### Input controls

This section shows the parameters of the input controls affected by stereo linking.

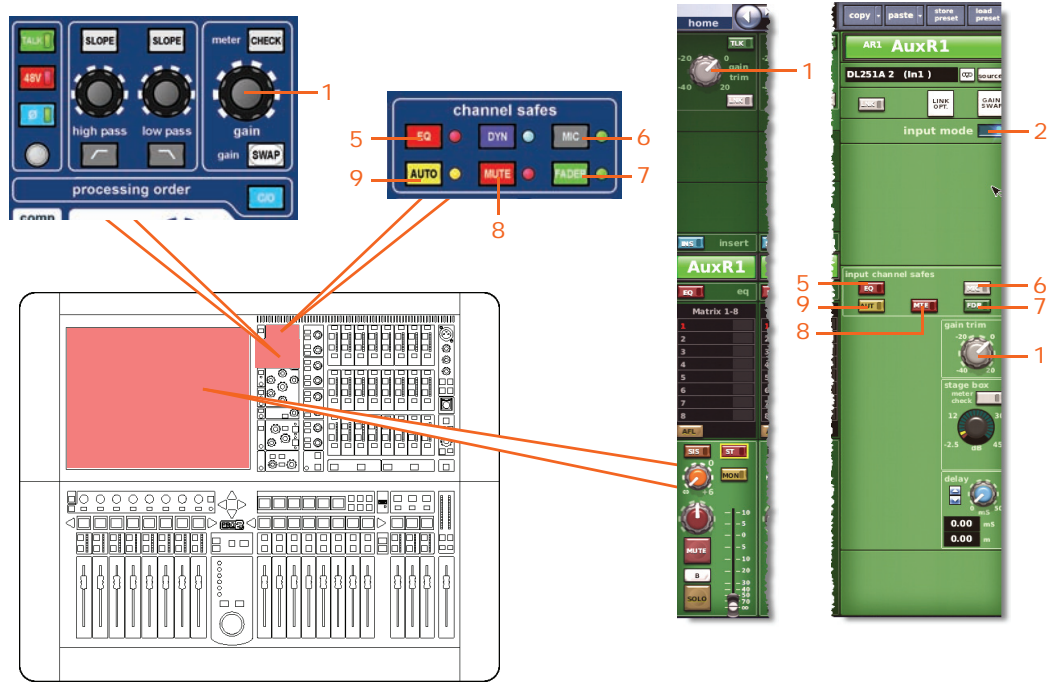

Item	Control	Parameter
1	Gain trim control knob	Digital trim level
2	input mode button	For time aligning the return channel with the input channels
5	EQ pushbutton	EQ safe on/off
6	MIC pushbutton	Mic safe on/off
7	FADER/[FDR] switch	Fader safe on/off
8	MUTE/[MTE] switch	Mute safe on/off
9	AUTO/[AUT] switch	Auto safe on/off

### Direct output

Not applicable.

### Direct input

Not applicable.

### Filters

Not applicable.

**Dynamics**

Not applicable.

**Insert**

This section shows the parameters of the insert section affected by stereo linking.

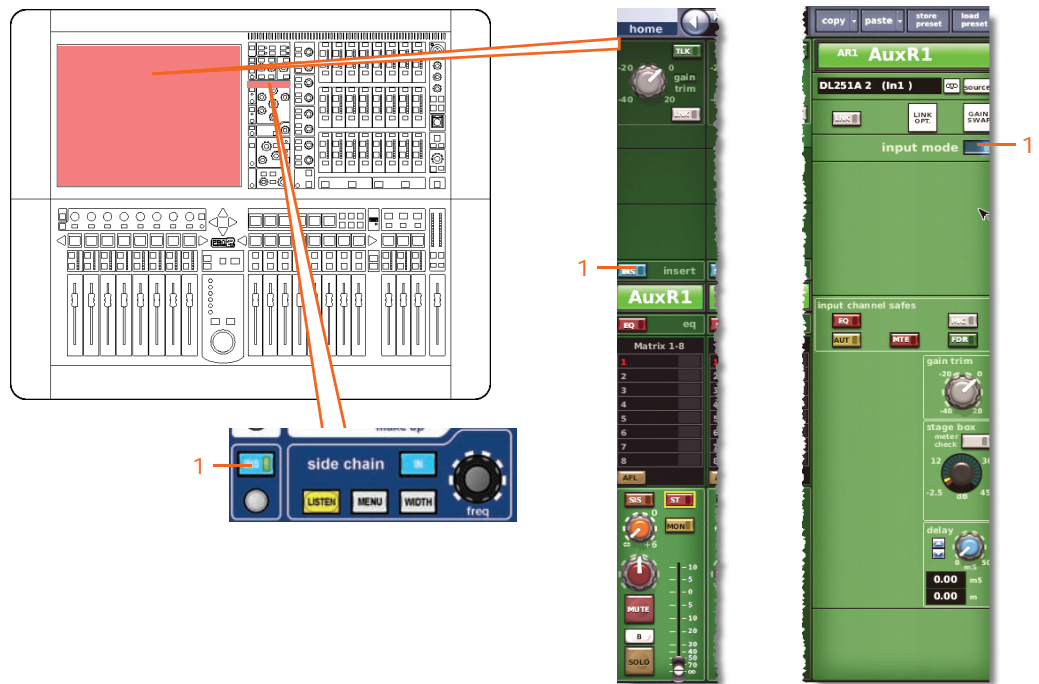

<i>Item</i>	<i>Control</i>	<i>Parameter</i>
1	INS switch	Insert in/out

EQ

The following diagram shows the EQ parameters affected by stereo linking.

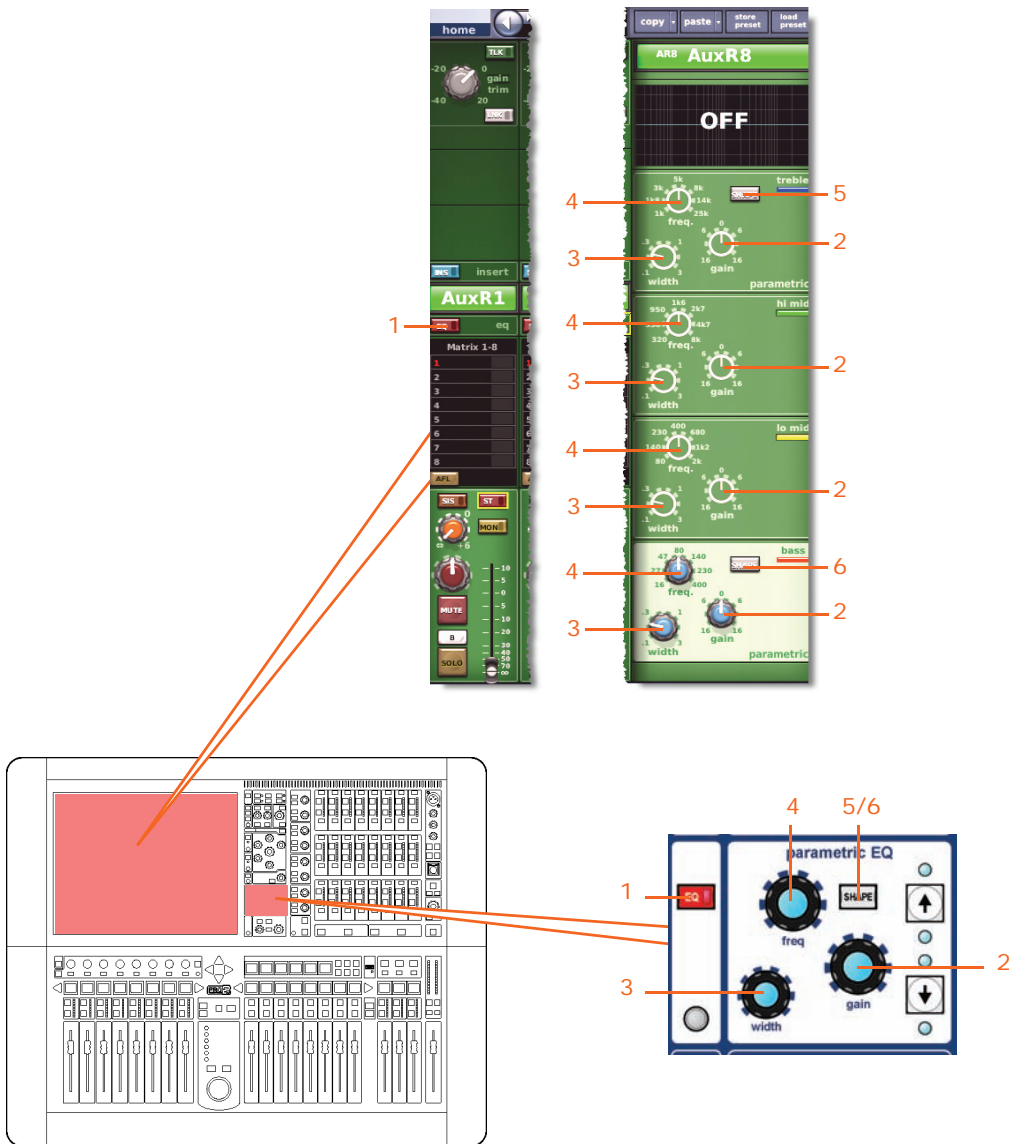

<i>Item</i>	<i>Control</i>	<i>Parameter</i>
1	EQ switch	EQ on/off
2	gain control knob	EQ gain level
3	width control knob	EQ width
4	freq control knob	EQ frequency
5	SHAPE switch	Treble shelving mode: parametric, bright, classic or soft
6	SHAPE switch	Bass shelving mode: parametric, deep, classic or warm

**Bus sends**

The following diagram shows the bus sends affected by stereo linking.

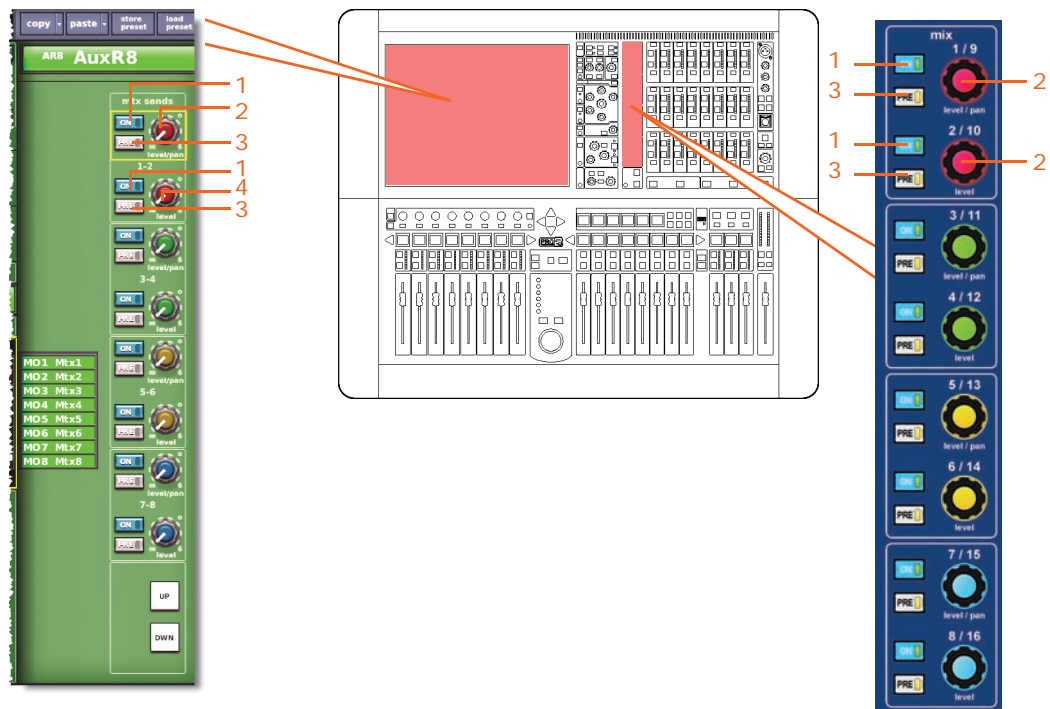

**Note:** Although only matrix sends 1-2 are referenced above, this also applies to all eight matrix sends.

Item	Control	Parameter
1	<b>ON</b> switch	Matrix bus send on/off
2	<b>level/pan</b> control knob	Bus level, or pan when bus is linked. (The pans are not linked, only the sends levels are linked.)
3	<b>PRE</b> switch	Pre-fader on/off
4	<b>level</b> control knob	Bus level

**Master routing**

This section shows the parameters of the master routing affected by stereo linking.

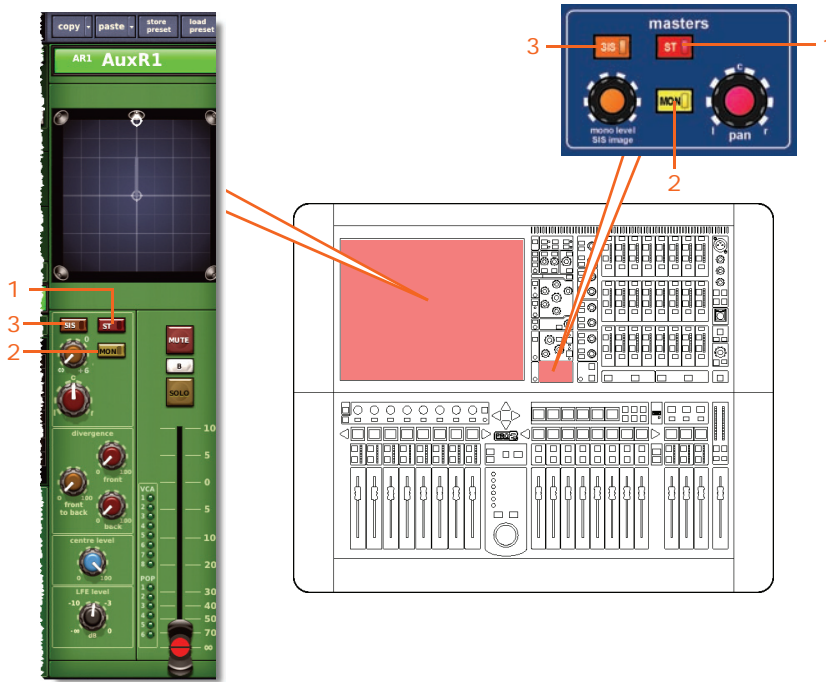

<i>Item</i>	<i>Control</i>	<i>Parameter</i>
1	ST switch	Stereo on/off
2	MON switch	Mono on/off
3	SIS switch	Spatial imaging system on/off



Fader

This section shows the fader parameters affected by stereo linking.

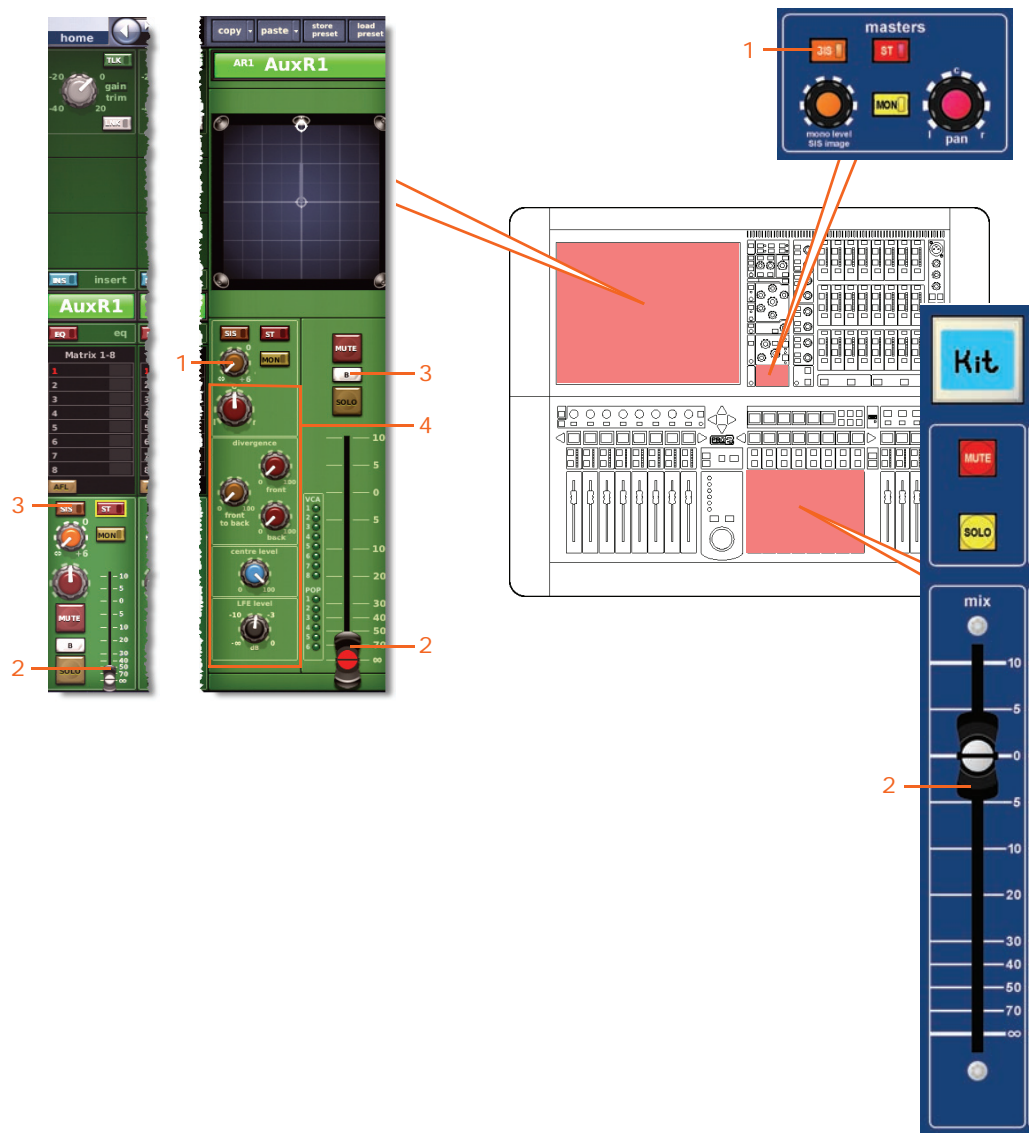

<i>Item</i>	<i>Control</i>	<i>Parameter</i>
1	<b>mono level/SIS image</b> control knob	Mono send level. (Only linked when <b>SIS</b> is out on both channels and surround mode is off.)
2	Fader	Level
3	<b>SOLO B/[B]</b>	Solo B on/off
4	Surround control knobs	Surround panning levels

Delay

The following diagram shows the delay parameters affected by stereo linking.

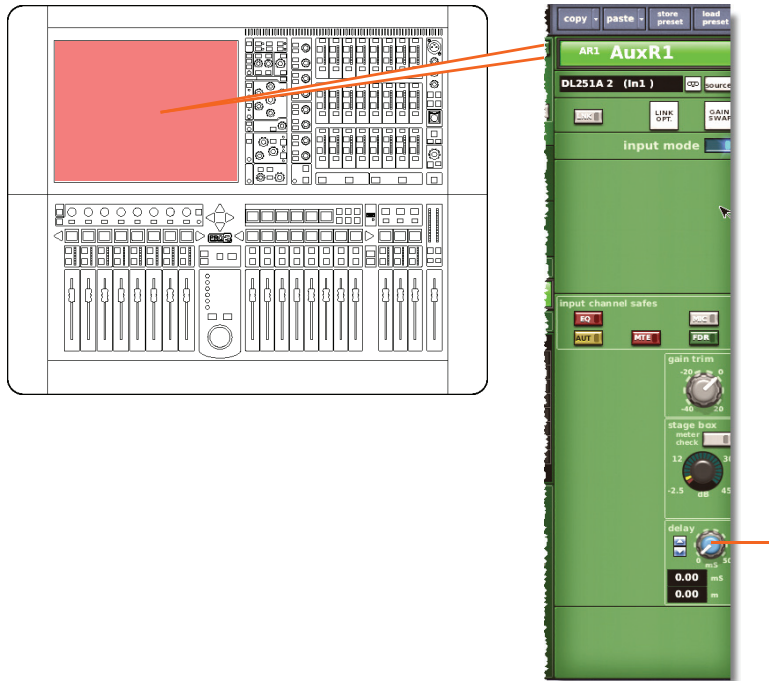

<i>Item</i>	<i>Control</i>	<i>Parameter</i>
1	delay control knob	Delay time

Mute

This section shows the mute parameters affected by stereo linking.

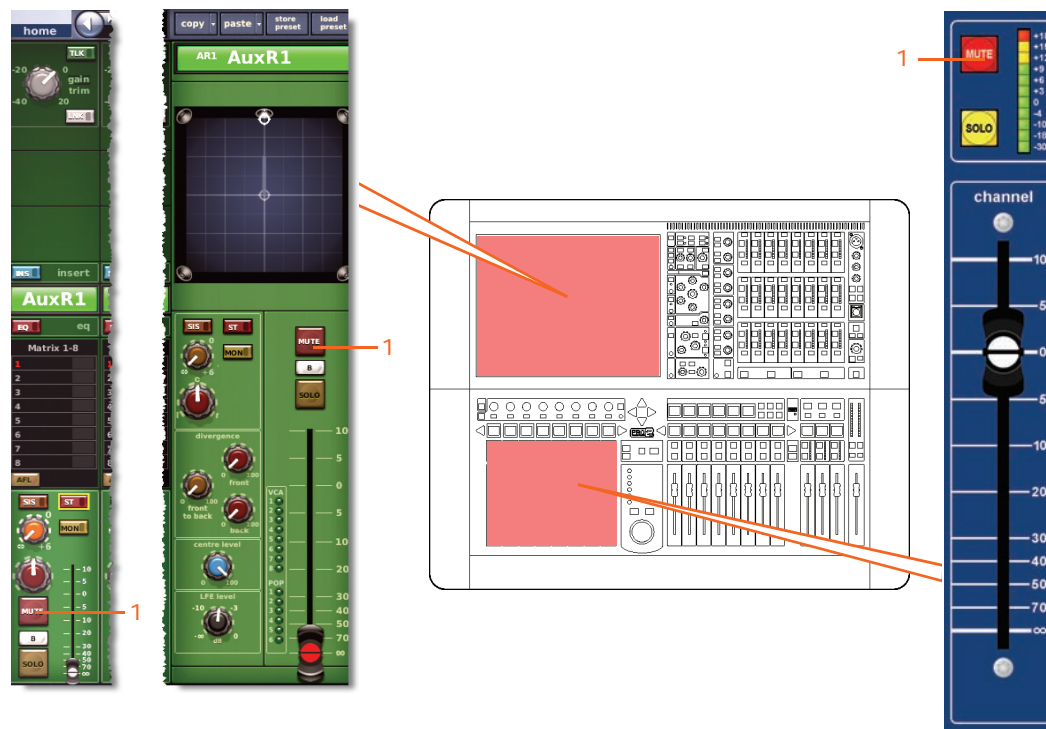

Item	Control	Parameter
1	MUTE button	Mutes the aux send signal

## Aux Sends

This section shows the linked parameters of the aux channels.

### Input controls

The following diagram shows the input control parameters that are linked across the channel pair.

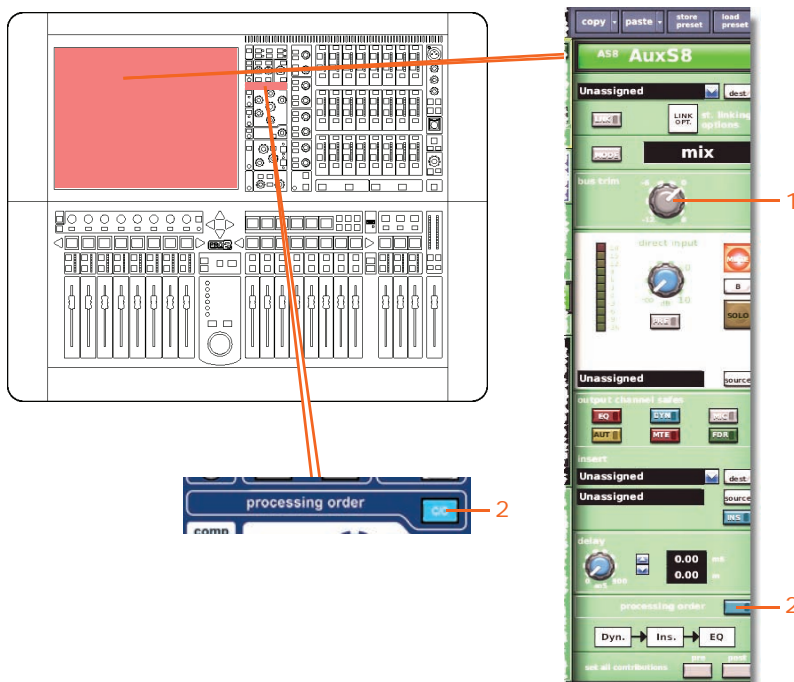

Item	Control	Parameter
1	bus trim control knob	Bus trim level
2	C/O switch	Order of processing: <b>Dyn.</b> → <b>Ins.</b> → <b>EQ</b> or <b>EQ</b> → <b>Ins.</b> → <b>Dyn.</b>

### Direct output

Not applicable.

**Direct input**

The following diagram shows the direct output control parameters that are linked across the aux channel pair.

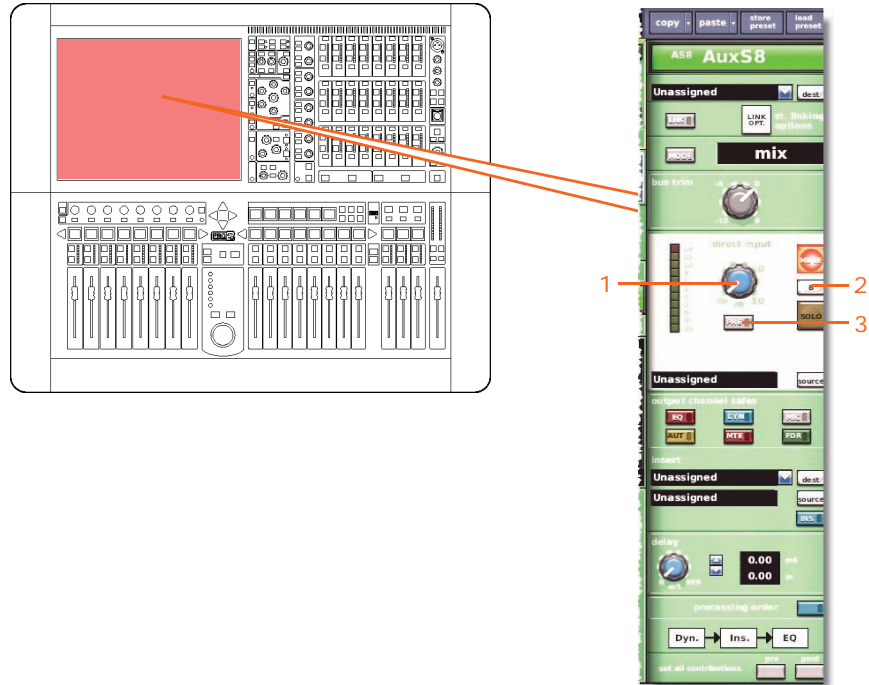

<i>Item</i>	<i>Control</i>	<i>Parameter</i>
1	level control knob	Direct input level
2	SOLO B/[B] switch	Direct input solo B on/off
3	MODE/[PRE] switch	Direct input pre- in/out

**Filters**

Not applicable.

Dynamics

This section shows the compression parameters of the dynamics section affected by stereo linking. Only corrective compressor shown below, but this is typically the same for the other compressor modes.

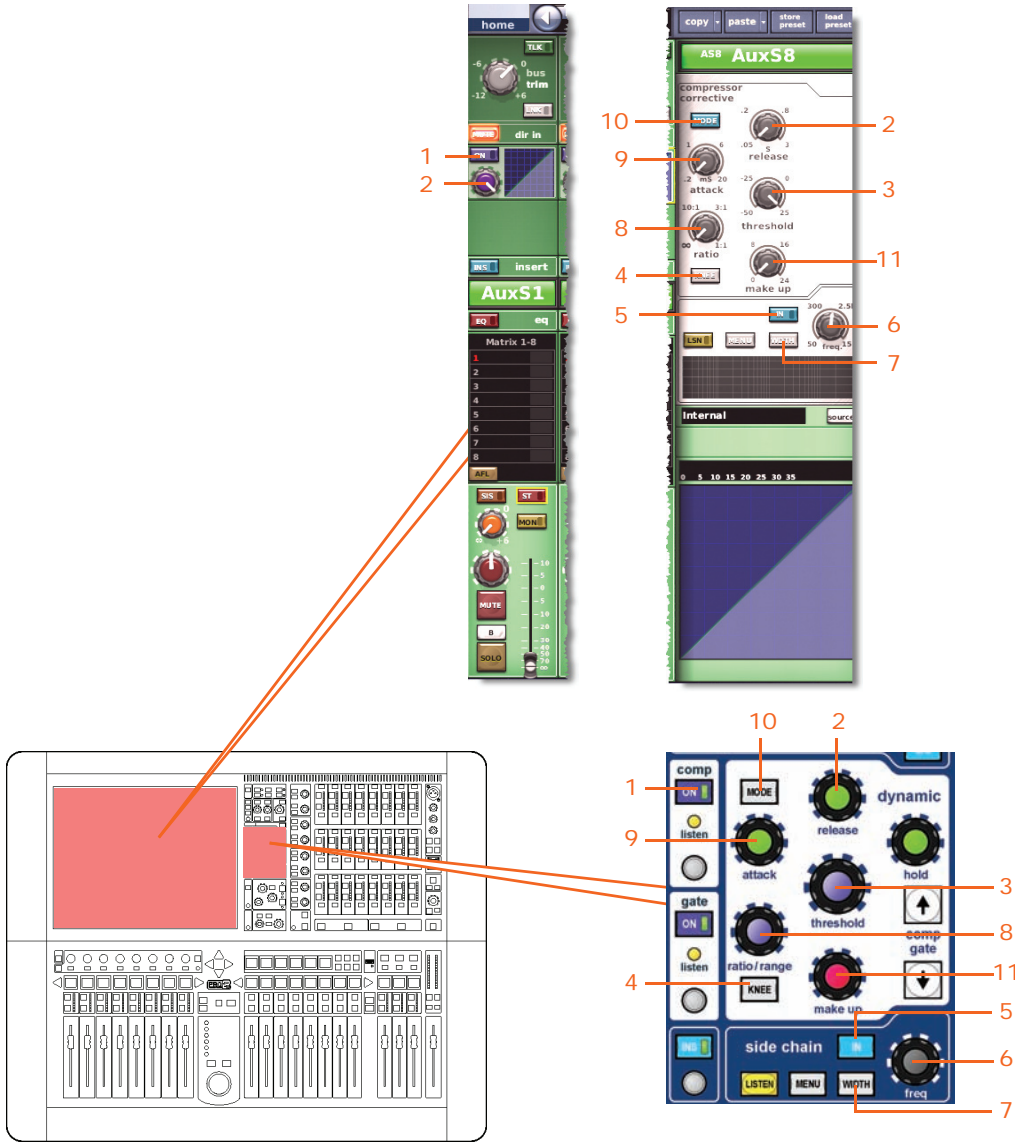

Item	Control	Parameter
1	<b>ON</b> switch	Compressor on/off
2	<b>release</b> control knob	Compressor release
3	<b>threshold</b> control knob	Compressor threshold
4	<b>KNEE</b> pushbutton	Compressor knee: hard, medium or soft
5	<b>IN</b> switch	Compressor sidechain in/out
6	<b>freq.</b> control knob	Compressor sidechain frequency
7	<b>WIDTH</b> pushbutton	Compressor sidechain width: 2 Oct, 1 Oct or 0.3 Oct

<i>Item</i>	<i>Control</i>	<i>Parameter</i>
<b>8</b>	<b>ratio</b> control knob	Compressor ratio
<b>9</b>	<b>attack</b> control knob	Compressor attack
<b>10</b>	<b>MODE</b> pushbutton	Compressor mode: corrective, adaptive, creative, vintage or shimmer
<b>11</b>	<b>make up</b> control knob	Compressor gain

**Insert**

This section shows the parameters of the insert section affected by stereo linking.

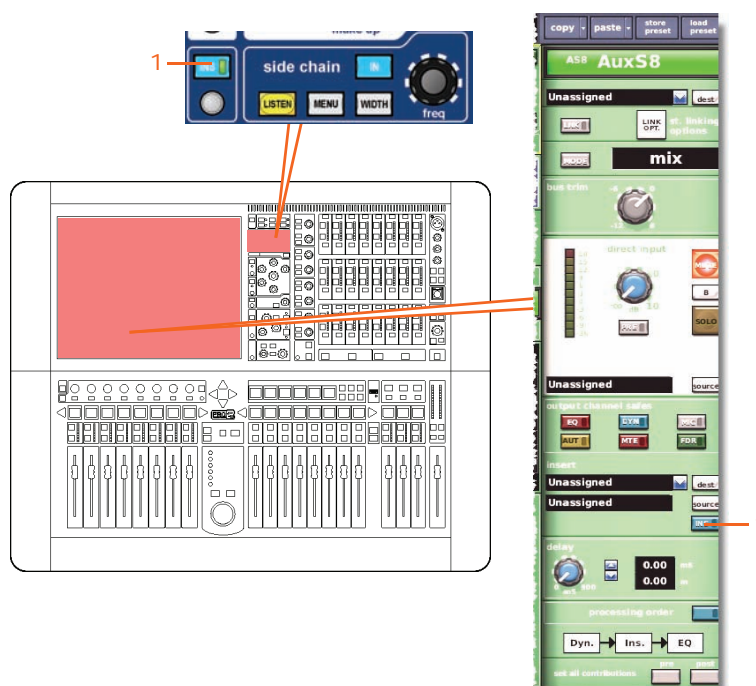

<i>Item</i>	<i>Control</i>	<i>Parameter</i>
<b>1</b>	<b>INS</b> switch	Insert in/out



EQ

This section shows the EQ and GEQ parameters affected by stereo linking.

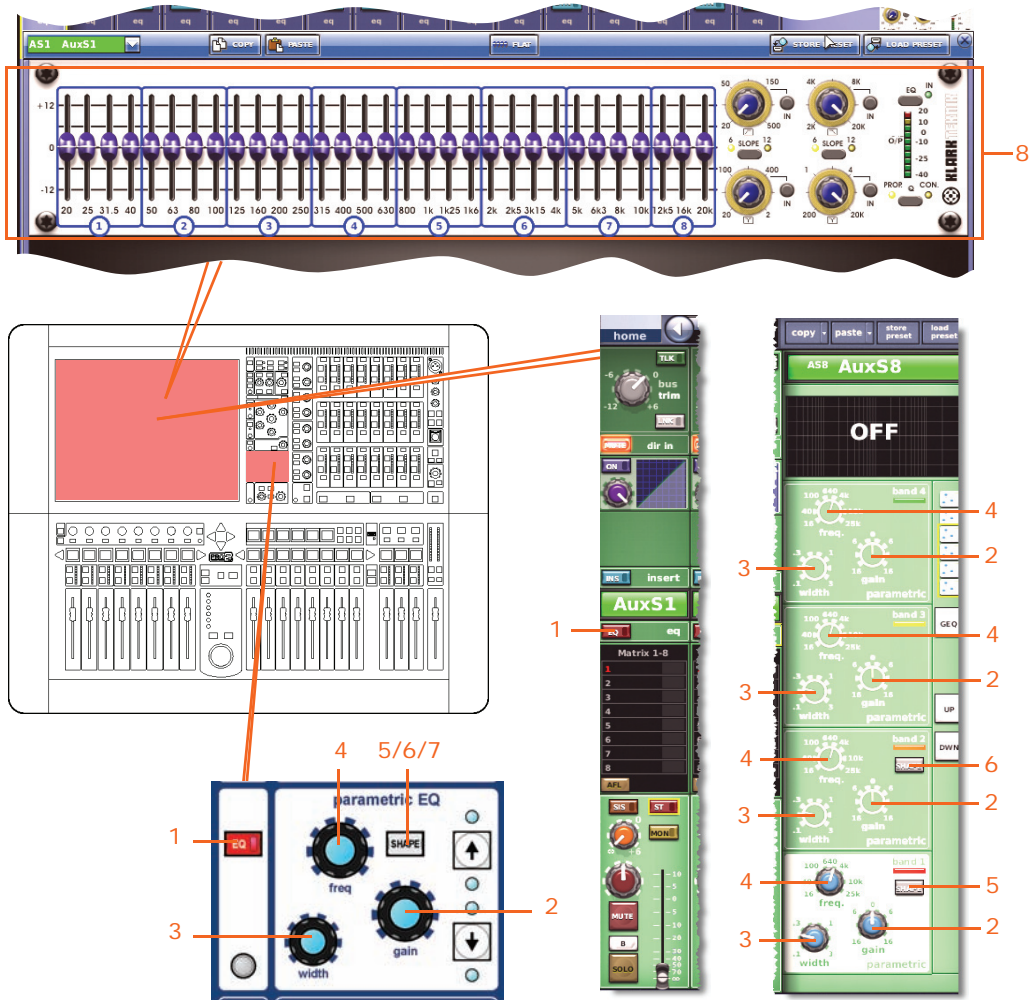

Item	Control	Parameter
1	EQ switch	EQ on/off
2	gain control knob	EQ gain level
3	width control knob	EQ width
4	freq control knob	EQ frequency
5	SHAPE switch	Band 1 shelving mode: bell, warm, high pass 6dB or high pass 12dB
6	SHAPE switch	Band 2 shelving mode: bell or high pass 24dB
7*	SHAPE switch	Band 6 shelving modes: bell, soft, low pass 6dB or low pass 12dB
8	GEQ	All GEQ parameters. (GEQ parameters linked when both linked channels have a GEQ assigned to them.)

\* Not shown in diagram.

**Note:** Although bands 5 and 6 are not shown above, the items in the table also apply. Both bands have items 2, 3 and 4, and band 6 also has item 7.



**Bus sends**

The following diagram shows the bus sends affected by stereo linking.

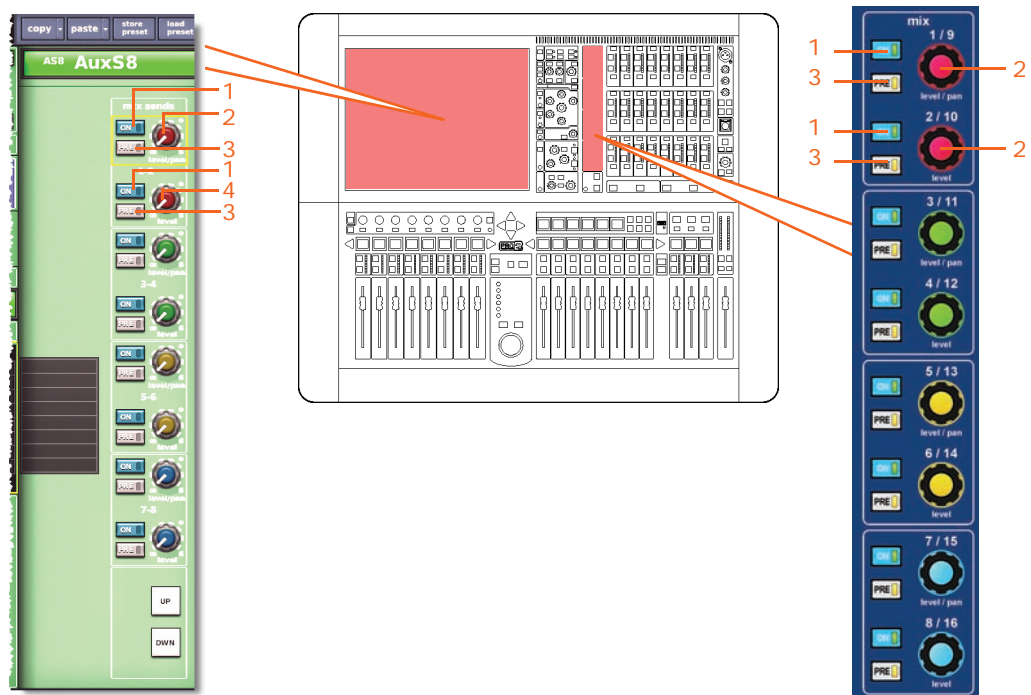

**Note:** Although only matrix sends 1-2 are referenced above, this also applies to all eight matrix sends.

Item	Control	Parameter
1	ON switch	Matrix bus send on/off
2	level/pan control knob	Bus level, or pan when bus is linked. (The pans are not linked, only the sends levels are linked.)
3	PRE switch	Pre-fader on/off
4	level control knob	Bus level

**Master routing**

This section shows the master routing parameters affected by stereo linking.

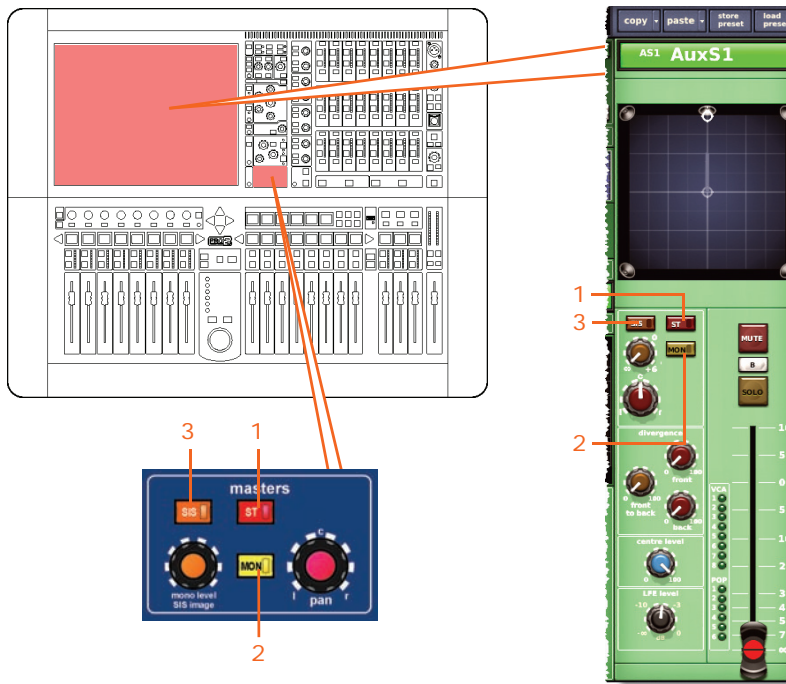

<i>Item</i>	<i>Control</i>	<i>Parameter</i>
1	ST switch	Stereo on/off
2	MON switch	Mono on/off
3	SIS switch	Spatial imaging system on/off

Fader

This section shows the fader parameters affected by stereo linking.

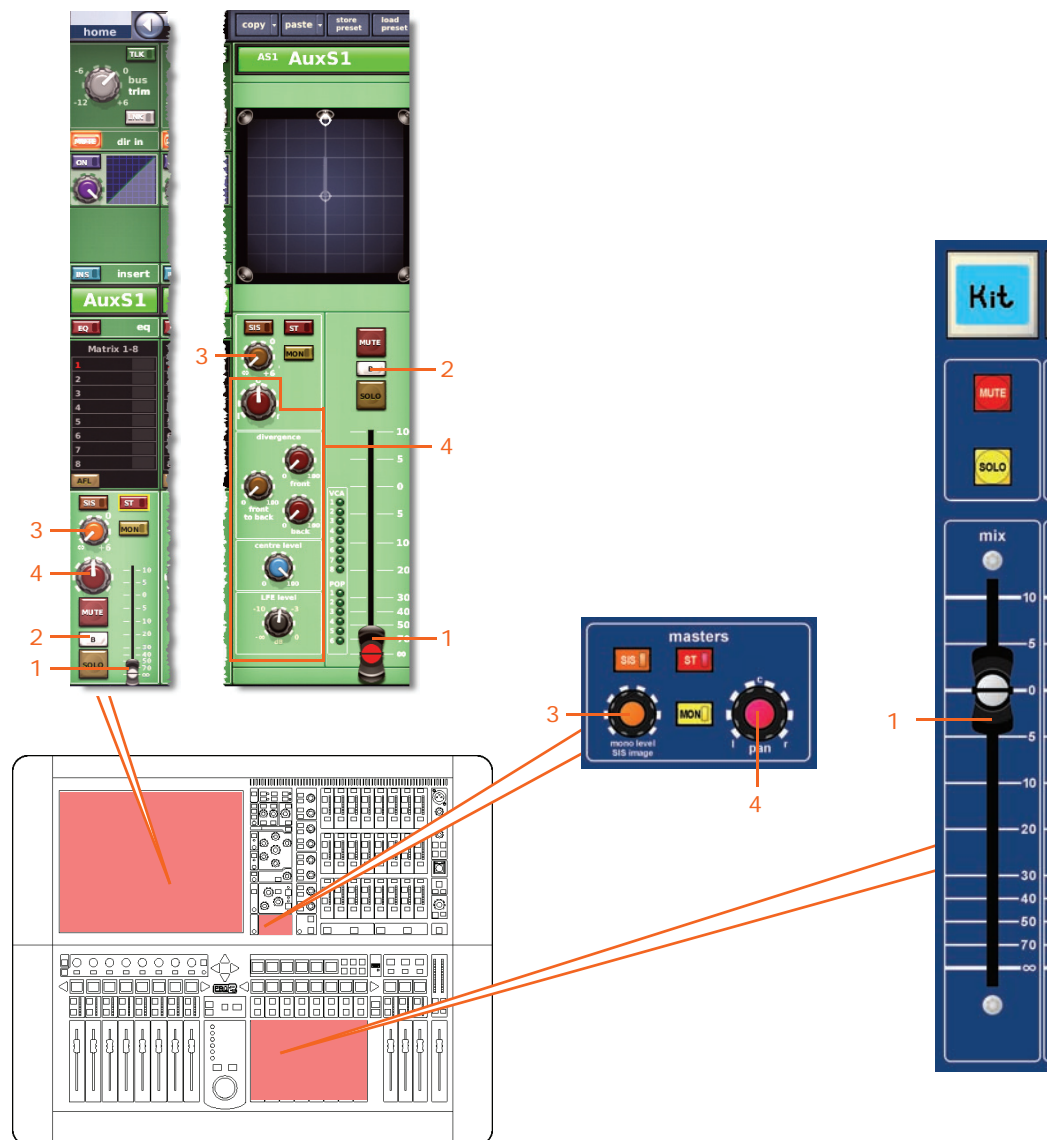

Item	Control	Parameter
1	Fader	Level
2	<b>SOLO B/[B]</b>	Solo B on/off
3	<b>mono level/SIS image</b> control knob	Mono send level. (Only linked when SIS is out on both channels and surround mode is not selected.)
4	Panning control knobs	Surround panning, which includes all surround sound parameters, provided <b>Surround Mode</b> is not configured as <b>None</b> (see "Selecting the surround mode" on page 209)

**Delay**

The following diagram shows the delay parameters affected by stereo linking.

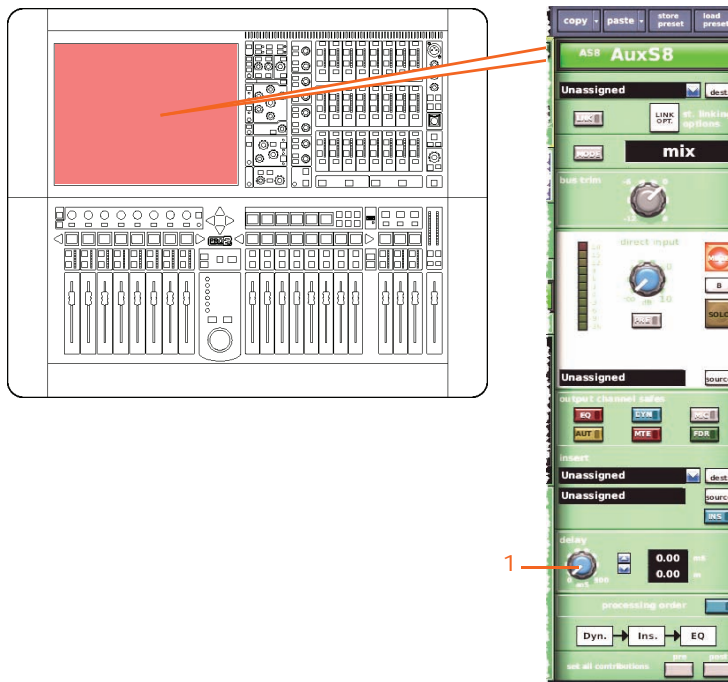

<i>Item</i>	<i>Control</i>	<i>Parameter</i>
<b>1</b>	<b>delay</b> control knob	Delay time

Mute

This section shows the mute parameters affected by stereo linking.

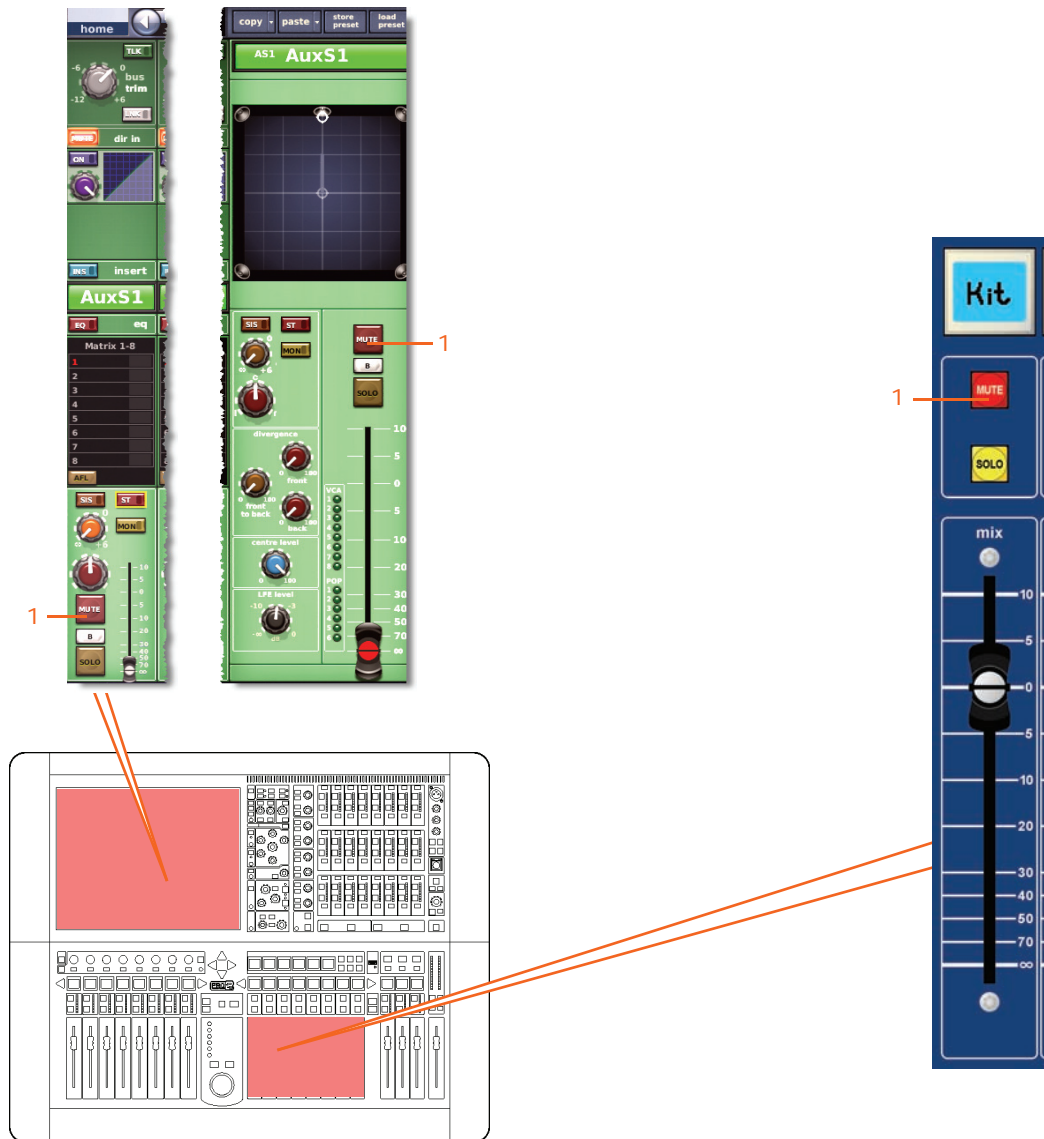

<i>Item</i>	<i>Control</i>	<i>Parameter</i>
1	MUTE button	Mutes the aux send signal

## Matrix

This section shows the linked parameters of the matrix channels.

### Input controls

The following diagram shows the input control parameters that are linked across the matrix channel pair.

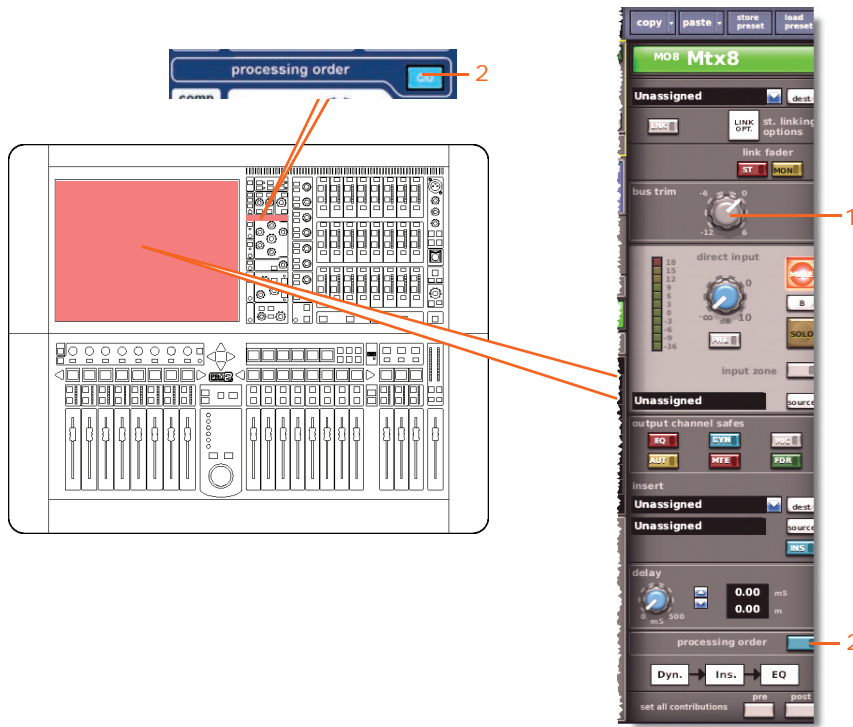

<i>Item</i>	<i>Control</i>	<i>Parameter</i>
1	Control knob	Bus trim level
2	C/O switch	Order of processing: <b>Dyn.</b> → <b>Ins.</b> → <b>EQ</b> or <b>EQ</b> → <b>Ins.</b> → <b>Dyn.</b>

### Direct output

Not applicable.

### Direct input

The following diagram shows the direct input control parameters that are linked across the matrix channel pair.

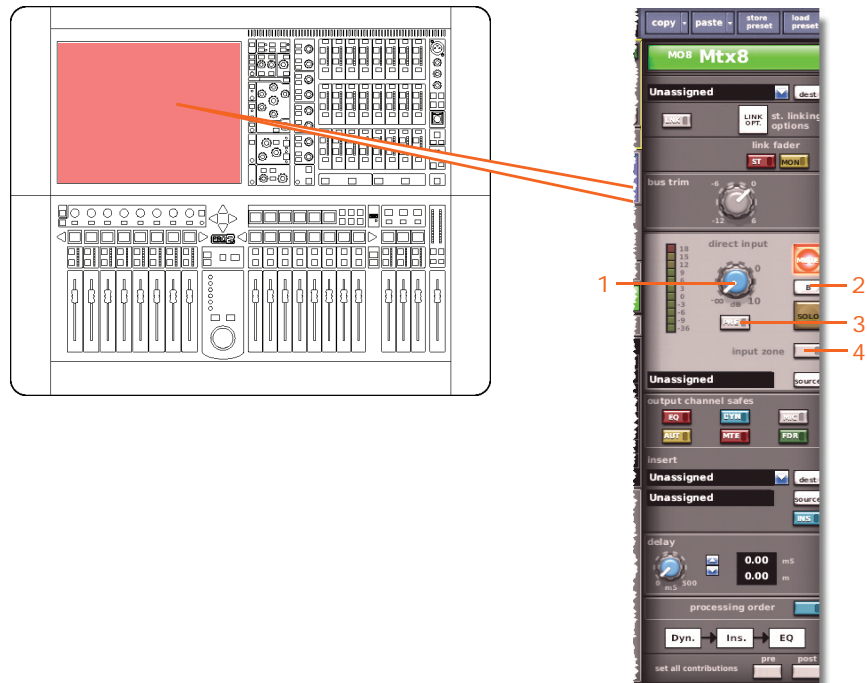

<i>Item</i>	<i>Control</i>	<i>Parameter</i>
1	level control knob	Direct input level
2	SOLO B/[B] switch	Direct input solo B on/off
3	MODE/[PRE] switch	Direct input pre- in/out
4	input zone switch	Input zone in/out

### Filters

Not applicable.

Dynamics

This section shows the compressor parameters affected by stereo linking. Only corrective compressor shown below, but this is typically the same for the other compressor modes.

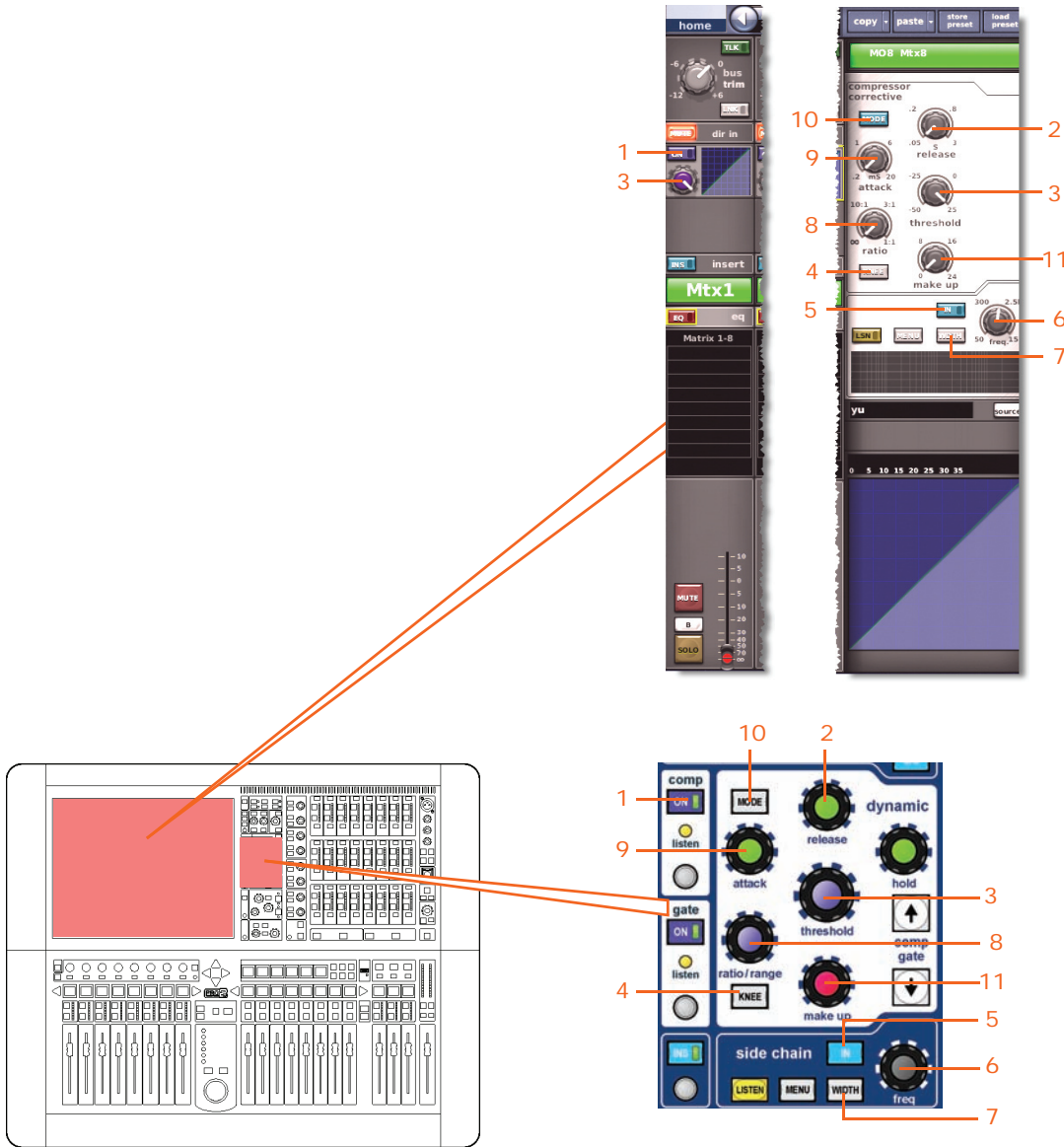

Item	Control	Parameter
1	ON switch	Compressor on/off
2	release control knob	Compressor release
3	threshold control knob	Compressor threshold
4	KNEE pushbutton	Compressor knee: hard, medium or soft
5	IN switch	Compressor sidechain in/out
6	freq. control knob	Compressor sidechain frequency



<i>Item</i>	<i>Control</i>	<i>Parameter</i>
7	<b>WIDTH</b> pushbutton	Compressor sidechain width: 2 Oct, 1 Oct or 0.3 Oct
8	<b>ratio</b> control knob	Compressor ratio
9	<b>attack</b> control knob	Compressor attack
10	<b>MODE</b> pushbutton	Compressor mode: corrective, adaptive, creative, vintage or shimmer
11	<b>make up</b> control knob	Compressor gain

**Insert**

This section shows the parameters of the insert section affected by stereo linking.

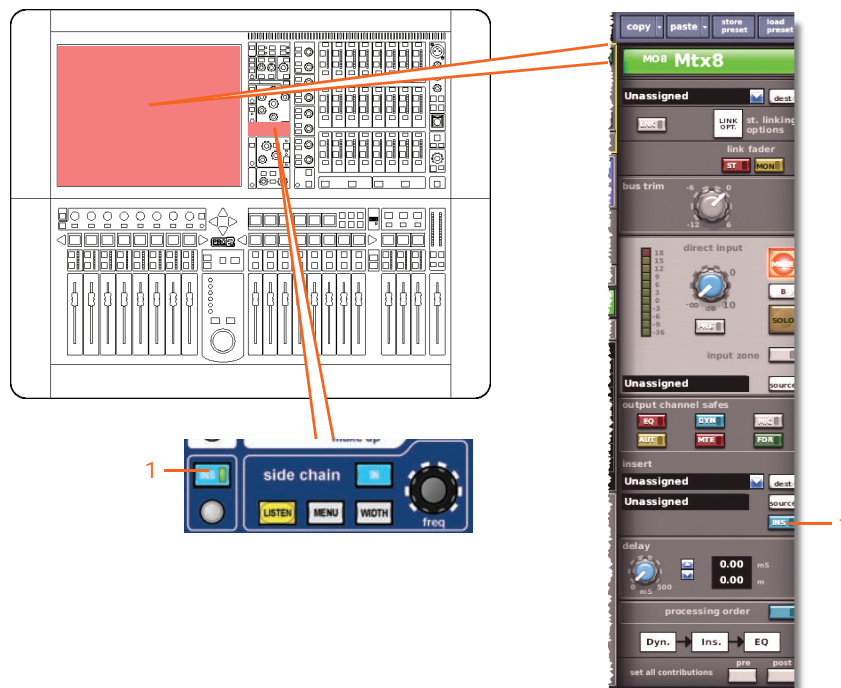

<i>Item</i>	<i>Control</i>	<i>Parameter</i>
1	<b>INS</b> switch	Insert in/out

EQ

This section shows the parameters of the EQ section affected by stereo linking.

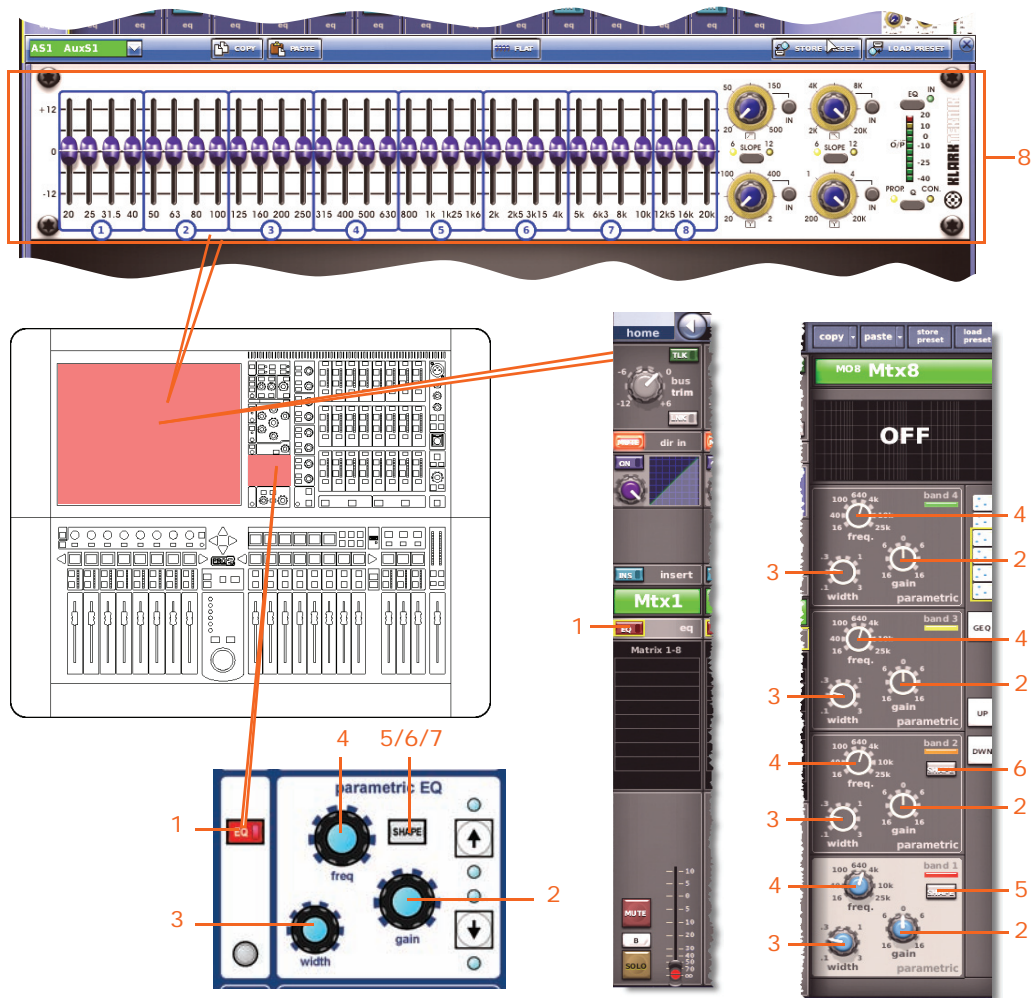

Item	Control	Parameter
1	EQ switch	EQ on/off
2	gain control knob	EQ gain level
3	width control knob	EQ width
4	freq. control knob	EQ frequency
5	SHAPE switch	Band 1 shelving mode: bell, warm, high pass 6dB or high pass 12dB
6	SHAPE switch	Band 2 shelving mode: bell or high pass 24dB
7*	SHAPE switch	Band 6 shelving mode: bell, soft, low pass 6dB or low pass 12dB
8	GEQ	All GEQ parameters. (GEQ parameters linked when both linked channels have a GEQ assigned to them.)

\* Not shown in diagram.

**Note:** Although bands 5 and 6 are not shown above, the items in the table also apply. Both bands have items 2, 3 and 4, and band 6 also has item 7.

**Bus sends**

Not applicable.

**Master routing**

Not applicable.

**Fader**

This section shows the fader parameters affected by stereo linking.

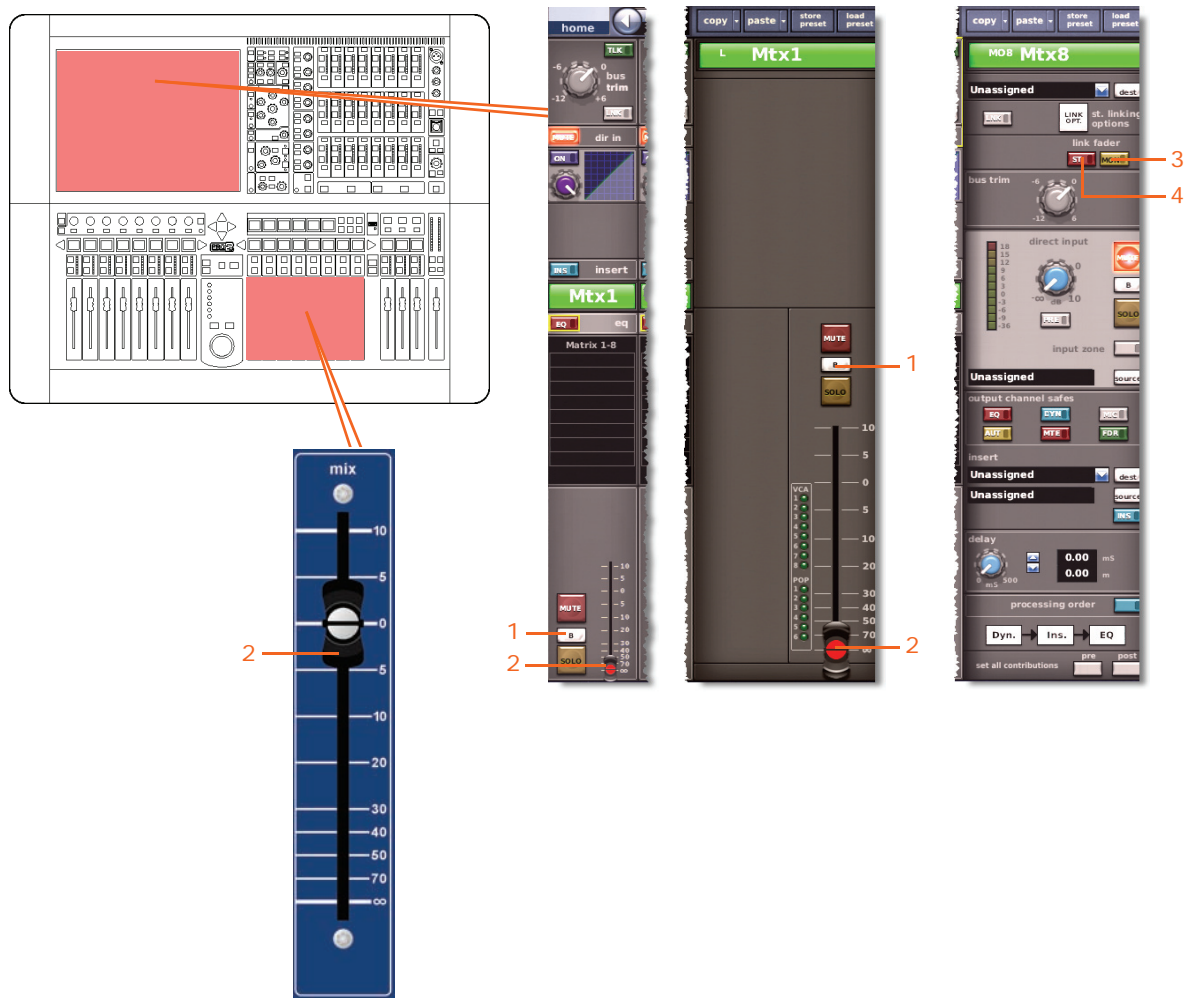

<i>Item</i>	<i>Control</i>	<i>Parameter</i>
1	<b>SOLO B/[B]</b>	Solo B on/off
2	Fader	Level
3	<b>MON</b> switch	Link to mono master fader
4	<b>ST</b> switch	Link to stereo master fader

Delay

The following diagram shows the delay parameters affected by stereo linking.

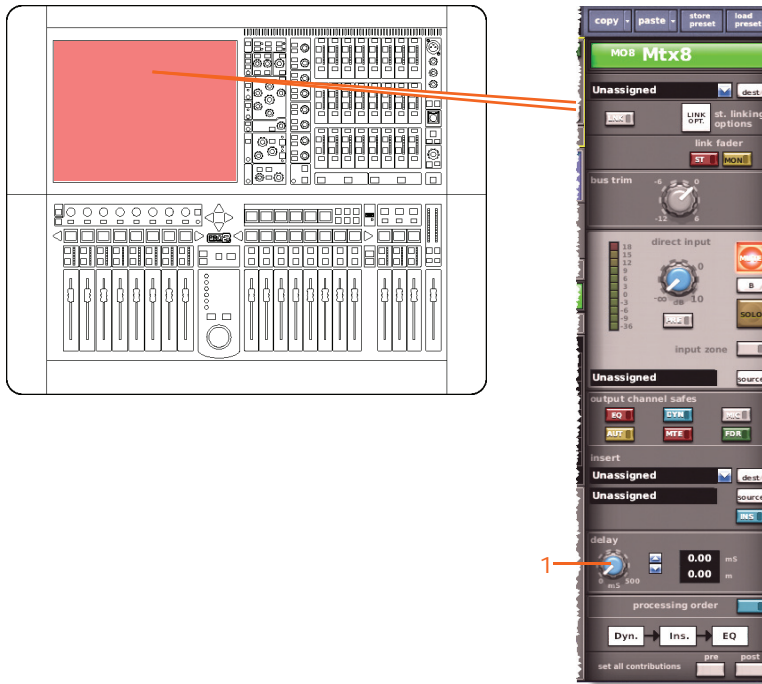

<i>Item</i>	<i>Control</i>	<i>Parameter</i>
1	delay control knob	Delay time

Mute

This section shows the mute parameters affected by stereo linking.

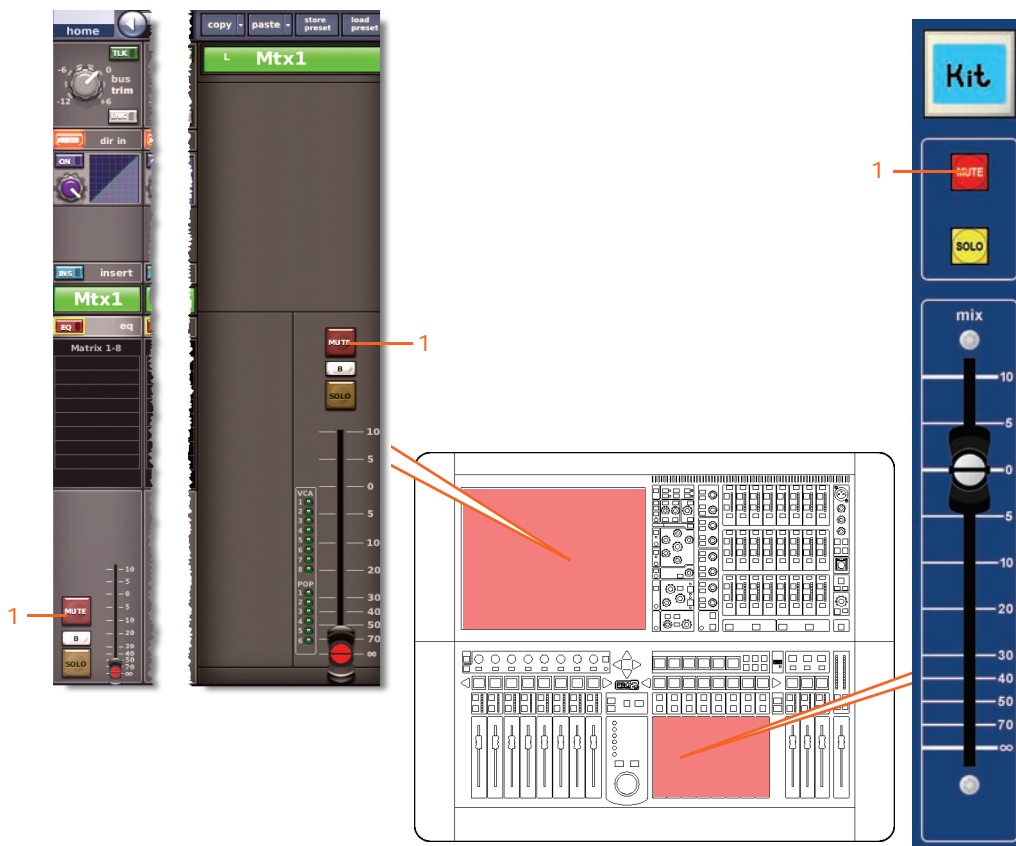

<i>Item</i>	<i>Control</i>	<i>Parameter</i>
1	MUTE button	Mutes the aux send signal

## Masters

This section shows the linked parameters of the master channels.

### Input controls

The following diagram shows the input control parameters that are linked across the master channel pair.

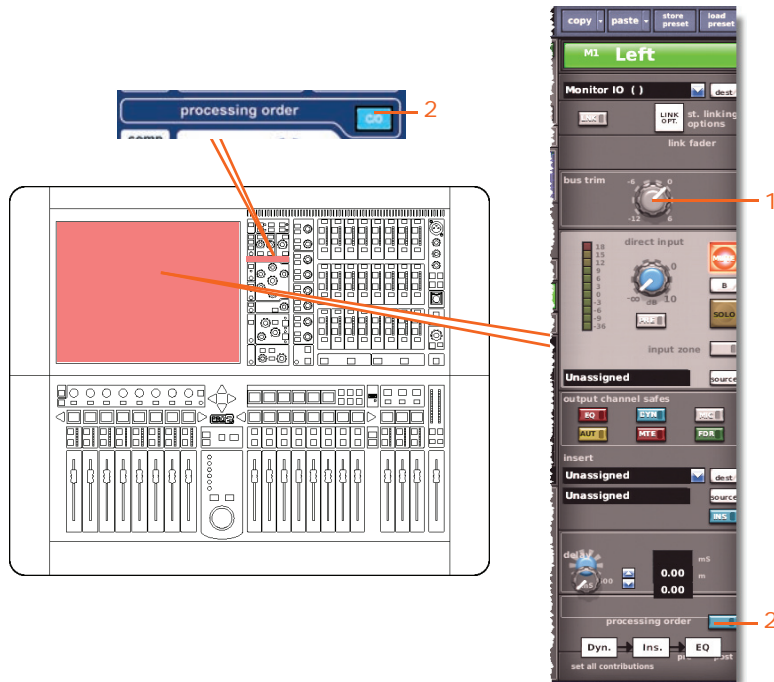

<i>Item</i>	<i>Control</i>	<i>Parameter</i>
1	Control knob	Bus trim level
2	C/O switch	Order of processing: <b>Dyn.</b> → <b>Ins.</b> → <b>EQ</b> or <b>EQ</b> → <b>Ins.</b> → <b>Dyn.</b>

### Direct output

Not applicable.

### Direct input

The following diagram shows the direct output control parameters that are linked across the master channel pair.

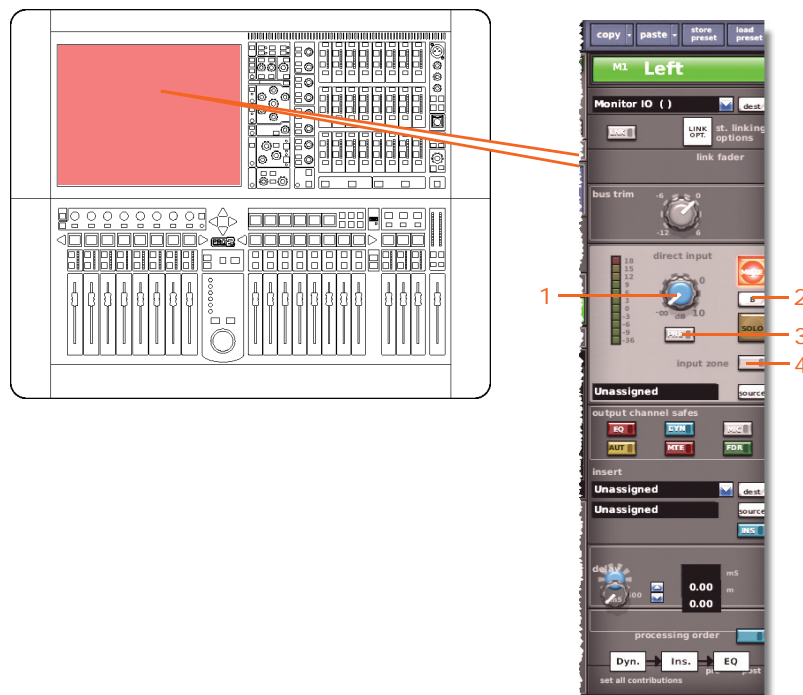

<i>Item</i>	<i>Control</i>	<i>Parameter</i>
1	level control knob	Direct input level
2	SOLO B/[B] switch	Direct input solo B on/off
3	MODE/[PRE] switch	Direct input pre- in/out
3	input zone switch	Input zone in/out

### Filters

Not applicable.



Dynamics

This section shows all the compression parameters of the dynamics section affected by stereo linking. Only corrective compressor shown below, but typically the same for the other compressor modes.

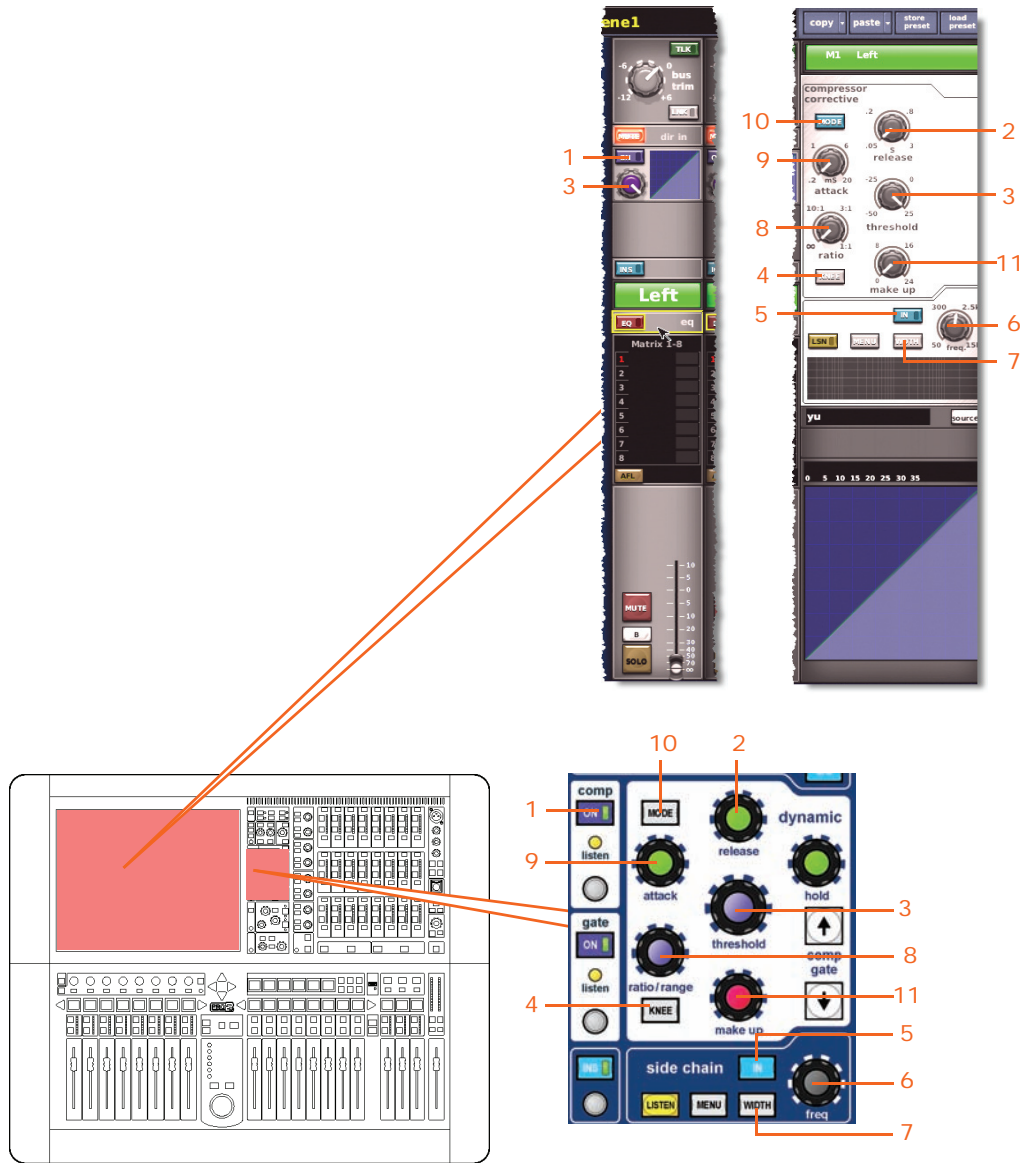

Item	Control	Parameter
1	ON switch	Compressor on/off
2	release control knob	Compressor release
3	threshold control knob	Compressor threshold
4	KNEE pushbutton	Compressor knee: hard, medium or soft
5	IN switch	Compressor sidechain in/out
6	freq. control knob	Compressor sidechain frequency



<i>Item</i>	<i>Control</i>	<i>Parameter</i>
7	<b>WIDTH</b> pushbutton	Compressor sidechain width: 2 Oct, 1 Oct or 0.3 Oct
8	<b>ratio</b> control knob	Compressor ratio
9	<b>attack</b> control knob	Compressor attack
10	<b>MODE</b> pushbutton	Compressor mode: corrective, adaptive, creative, vintage or shimmer
11	<b>make up</b> control knob	Compressor gain

**Insert**

This section shows the parameters of the insert section affected by stereo linking.

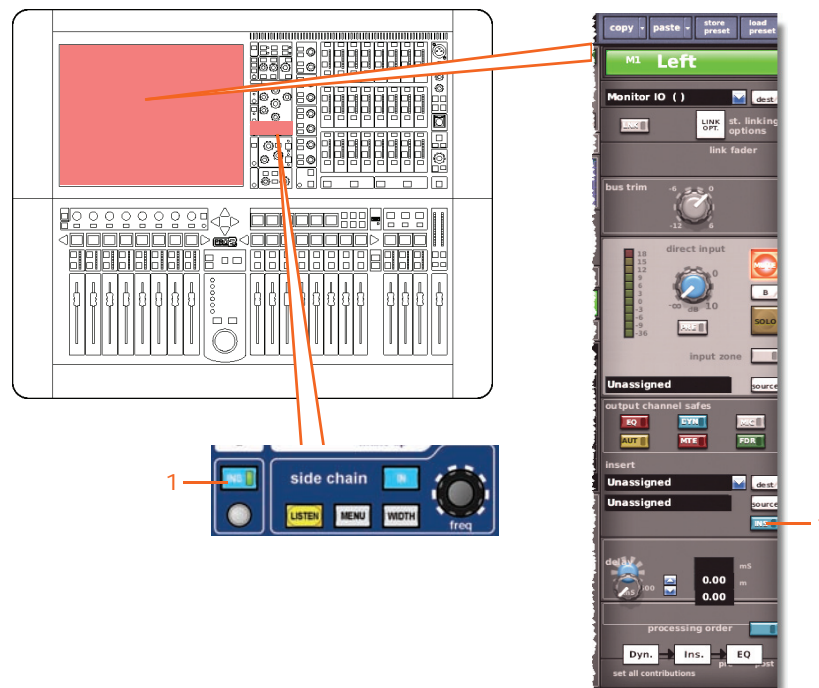

<i>Item</i>	<i>Control</i>	<i>Parameter</i>
1	<b>INS</b> switch	Insert in/out

EQ

This section shows the parameters of the EQ section affected by stereo linking.

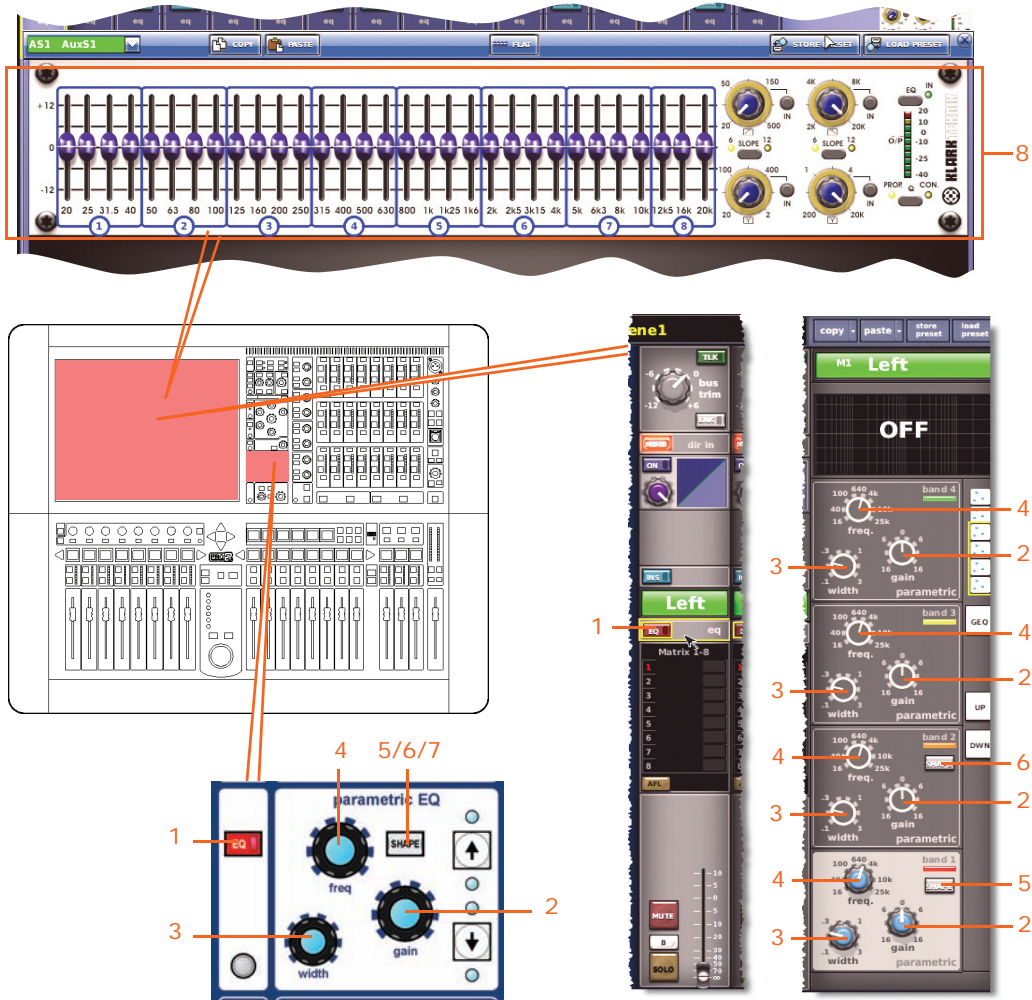

Item	Control	Parameter
1	EQ switch	EQ on/off
2	gain control knob	EQ gain level
3	width control knob	EQ width
4	freq. control knob	EQ frequency
5	SHAPe switch	Band 1 shelving mode: bell, warm, high pass 6dB or high pass 12dB
6	SHAPe switch	Band 2 shelving mode: bell or high pass 24dB
7*	SHAPe switch	Band 6 shelving mode: bell, soft, low pass 6dB or low pass 12dB
8	GEQ	All GEQ parameters. (GEQ parameters linked when both linked channels have a GEQ assigned to them.)

\* Not shown in diagram.

**Note:** Although bands 5 and 6 are not shown above, the items in the table also apply. Both bands have items 2, 3 and 4, band 6 also has item 7.

**Bus sends**

The following diagram shows the bus sends affected by stereo linking.

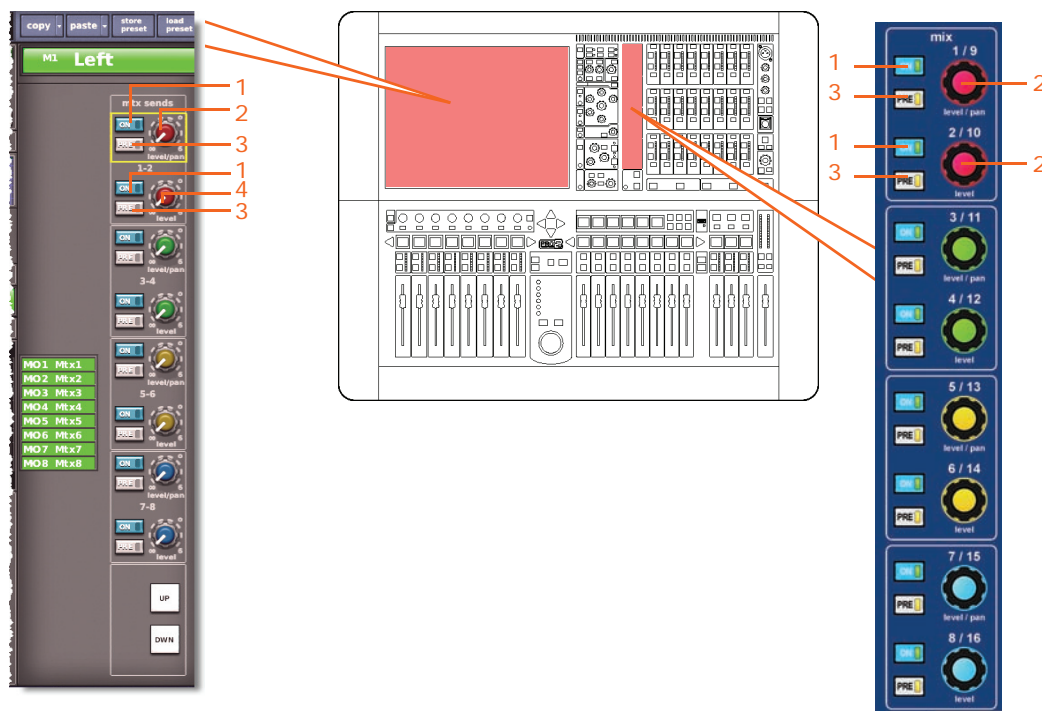

**Note:** Although only matrix sends 1-2 are referenced above, this also applies to all eight matrix sends.

Item	Control	Parameter
1	<b>ON</b> switch	Matrix bus send on/off
2	<b>level/pan</b> control knob	Bus level, or pan when bus is linked. (The pans are not linked, only the sends levels are linked.)
3	<b>PRE</b> switch	Pre-fader on/off
4	<b>level</b> control knob	Bus level

**Master routing**

This section shows the master routing parameters affected by stereo linking.

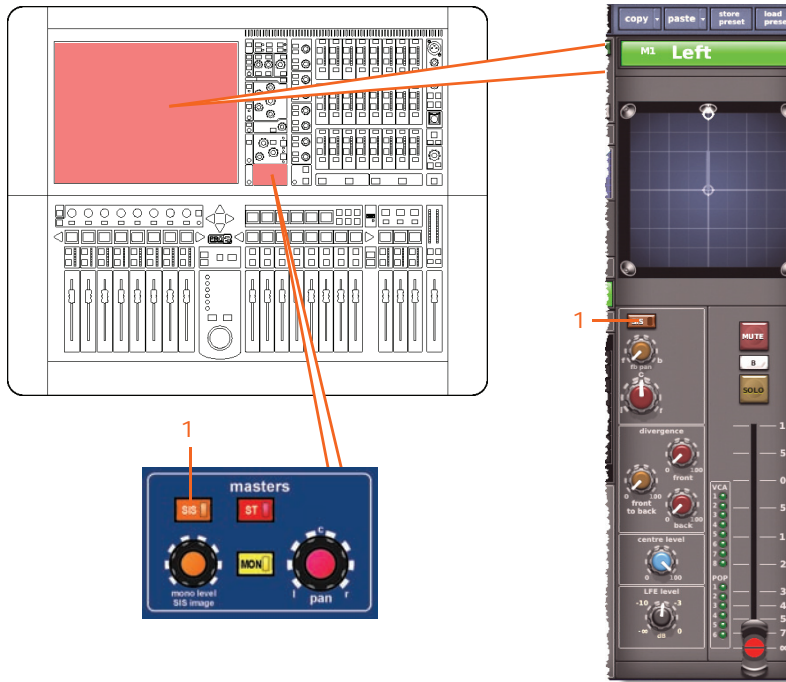

<i>Item</i>	<i>Control</i>	<i>Parameter</i>
1	SIS switch	Spatial imaging system on/off. (Only available if one of the surround modes is selected.)

Fader

This section shows the fader parameters affected by stereo linking.

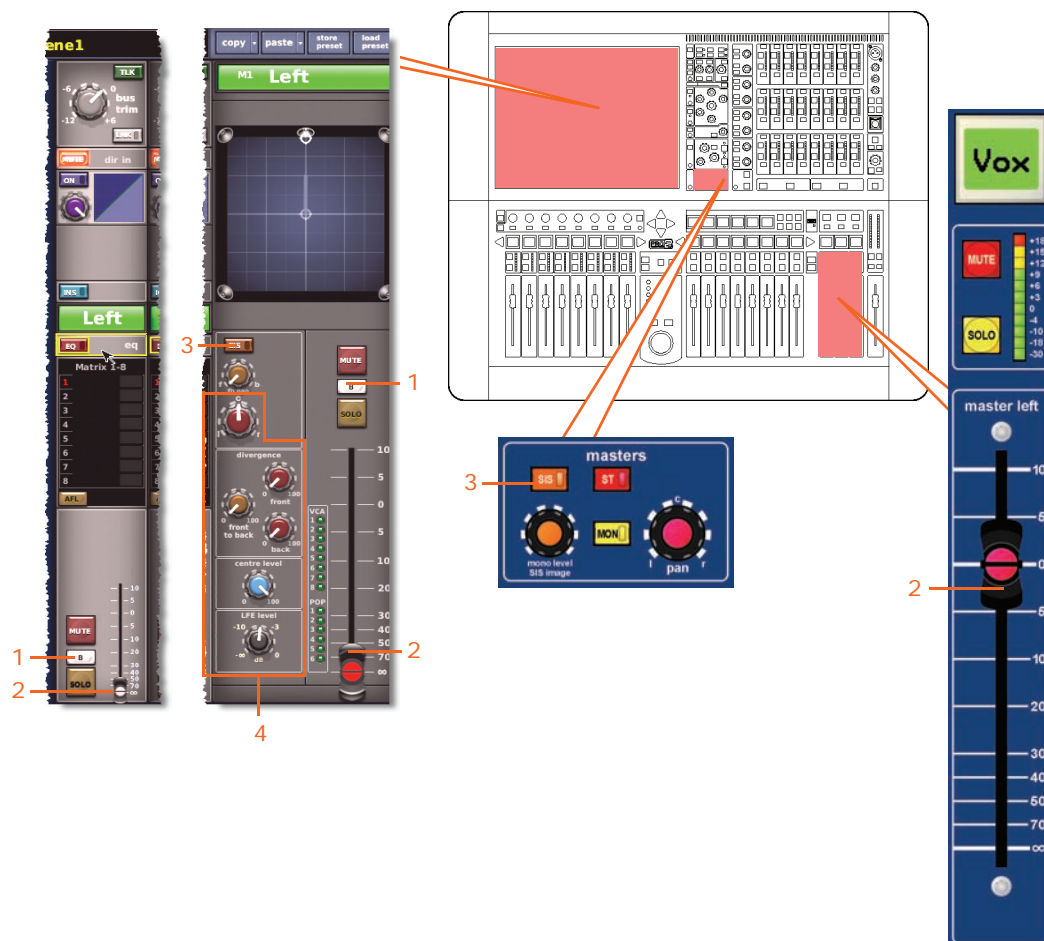

Item	Control	Parameter
1	<b>SOLO B/[B]</b>	Solo B on/off
2	Fader	Level
3	<b>SIS</b> switch	Route to surround on/off
4	Surround control knobs	Surround panning levels

Delay

The following diagram shows the delay parameters affected by stereo linking.

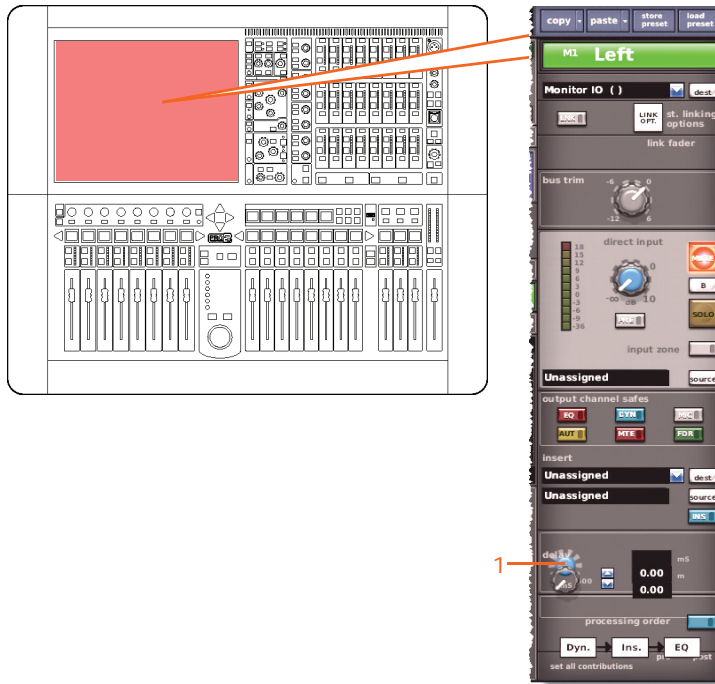

<i>Item</i>	<i>Control</i>	<i>Parameter</i>
1	delay control knob	Delay time

Mute

This section shows the mute parameters affected by stereo linking.

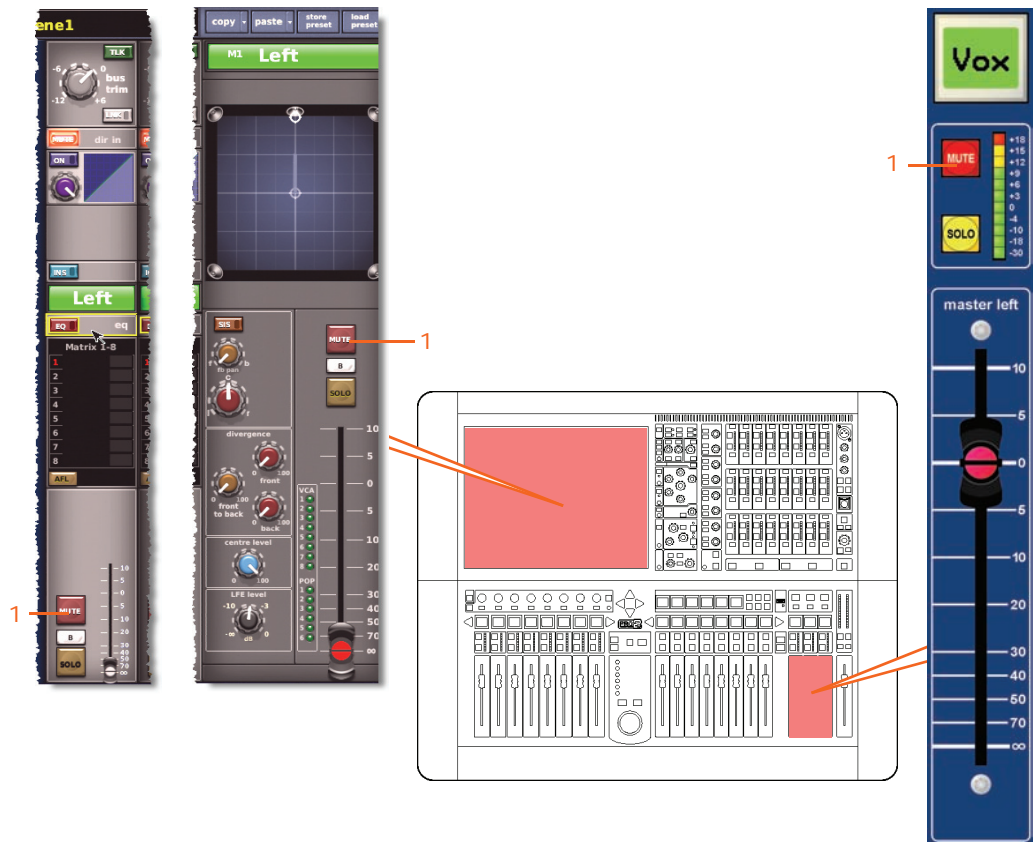

Item	Control	Parameter
1	MUTE button	Mutes the aux send signal





## Appendix K: Parameters Copied Through Scenes

This appendix shows the parameters per section — selected from the **Sections** panel in the **Show Editor** screen (shown below) — that can be copied through scenes.

The screenshot displays the **Show Editor** interface for **Scene2**. The interface is divided into several panels:

- Inputs:** A list of 16 microphone inputs (IN1 Mic1 to IN16 Mic16).
- Aux Sends:** A list of 16 auxiliary sends (AS1 AuxS1 to AS16 AuxS16).
- GEQs:** A list of 8 graphic equalizers (GEQ1 Geq1 to GEQ8 Geq8).
- Effects:** A list of 6 effects (FX1 Ifx1 to FX6 Ifx6).
- VCA/POP:** A list of 8 variable gain amplifiers (VCA1 VCA1 to VCA8 VCA8).
- Masters:** A list of 3 master outputs (M1 Left, M2 Right, M3 Mono).
- Assignables:** A section for assignable parameters.
- Sections:** A panel with checkboxes for:
  - Config sections
  - Comp./Output Dyn
  - Gates
  - EQs
  - Fader Sections
  - Recall Scope
  - Store Scope
  - Routing
- Aux Sends Matrix:** A 4x4 grid of checkboxes for routing auxiliary sends to matrix buses.
 

<input checked="" type="checkbox"/>	<input checked="" type="checkbox"/>	<input checked="" type="checkbox"/>	<input checked="" type="checkbox"/>
<input checked="" type="checkbox"/>	<input checked="" type="checkbox"/>	<input checked="" type="checkbox"/>	<input checked="" type="checkbox"/>
<input checked="" type="checkbox"/>	<input checked="" type="checkbox"/>	<input checked="" type="checkbox"/>	<input checked="" type="checkbox"/>
<input checked="" type="checkbox"/>	<input checked="" type="checkbox"/>	<input checked="" type="checkbox"/>	<input checked="" type="checkbox"/>
- Matrix Sends Matrix:** A 4x4 grid of checkboxes for routing matrix buses to other matrix buses.
 

<input checked="" type="checkbox"/>	<input checked="" type="checkbox"/>	<input checked="" type="checkbox"/>	<input checked="" type="checkbox"/>
<input checked="" type="checkbox"/>	<input checked="" type="checkbox"/>	<input checked="" type="checkbox"/>	<input checked="" type="checkbox"/>
<input checked="" type="checkbox"/>	<input checked="" type="checkbox"/>	<input checked="" type="checkbox"/>	<input checked="" type="checkbox"/>
<input checked="" type="checkbox"/>	<input checked="" type="checkbox"/>	<input checked="" type="checkbox"/>	<input checked="" type="checkbox"/>
- Scenelist:** A list of scenes: 0 safe, 1 Scene1, 2 Scene2.

At the bottom of the interface, there are buttons for **ALL**, **NONE**, and **PASTE TO SCENES**. The status bar at the bottom indicates "Requested show save" and "Done".

## Inputs (input channels)

This section shows you which parameters for each of the 96 input channels are affected by copy through scenes.

### Config sections

The following diagram shows the parameters of the input channel configuration detail area copied through scenes.

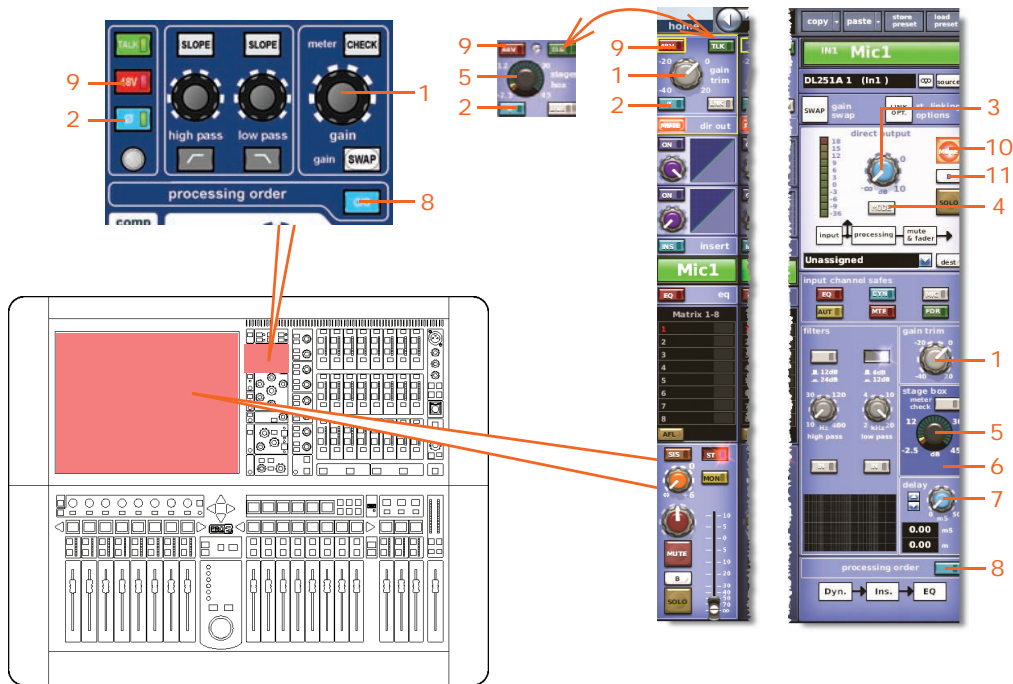

Item	Control	Parameter
1	gain trim control knob	Digital trim level
2	Ø switch	Phase on/off switch
3	level control knob	Direct output level
4	MODE switch	Direct output tap-off point: "Post-fade and mute", "Pre-mute, pre-processing" and "Pre-mute, post-processing"
5	stage box control knob*	Remote amplifier level
6	30Hz switch*	30Hz filter on/off
7	delay control knob	Delay time
8	C/O switch	Order of processing: <b>Dyn.</b> → <b>Ins.</b> → <b>EQ</b> or <b>EQ</b> → <b>Ins.</b> → <b>Dyn.</b>
9	48V switch*	48V phantom voltage on/off
10	MUTE switch	Direct output mute on/off
11	SOLO B/[B] switch	Direct output solo B on/off

\* Applies to primary and tape inputs.

Comp./Output Dyn

The following diagram shows the input channel compressor parameters copied through scenes.

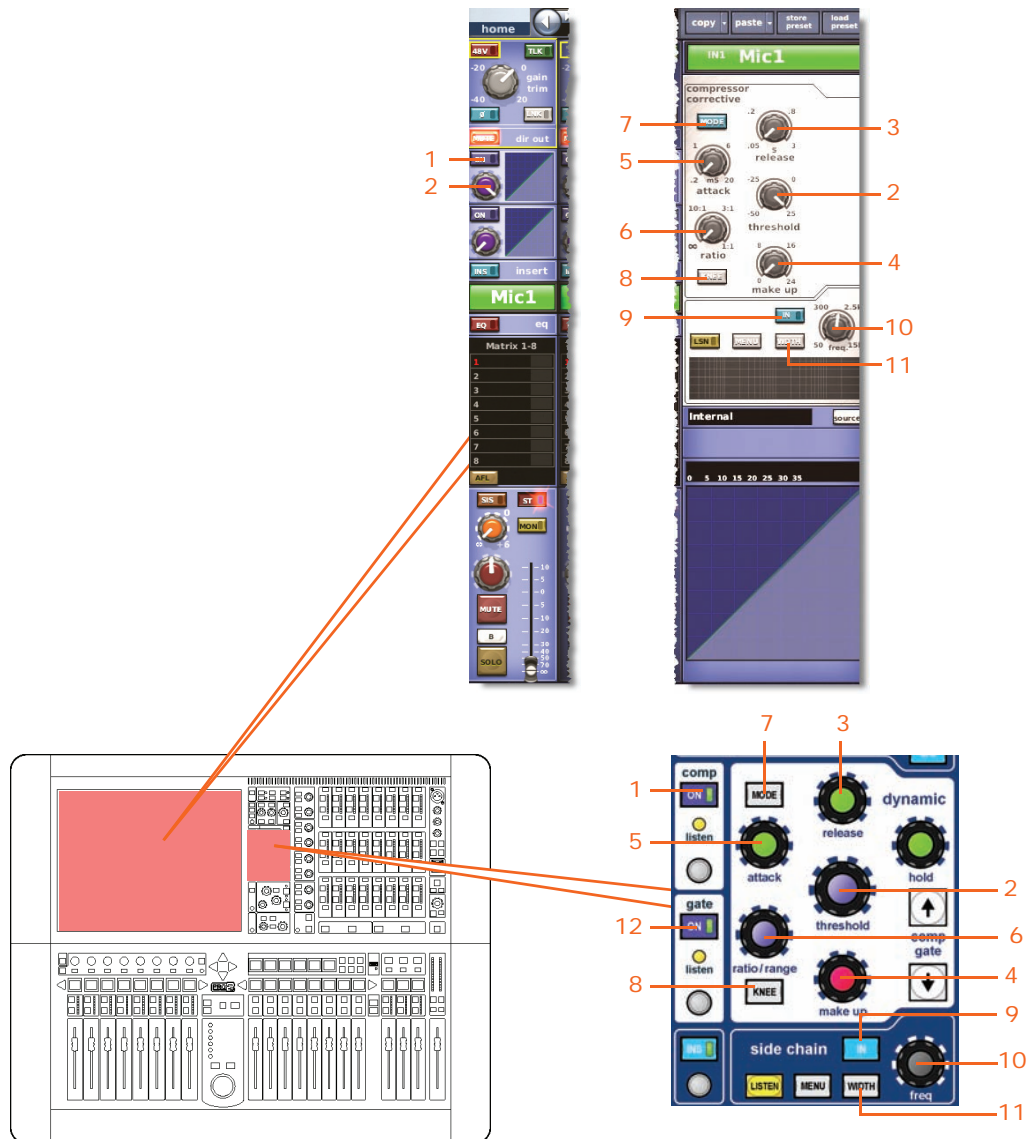

**Note:** Only the corrective compressor is shown above, but this is typically the same for the other compressor modes (adaptive, creative and vintage).

Item	Control	Parameter
1	ON switch	Compressor on/off
2	threshold control knob	Compressor threshold
3	release control knob	Compressor release
4	make up control knob	Compressor make up gain
5	attack control knob	Compressor attack

<i>Item</i>	<i>Control</i>	<i>Parameter</i>
6	<b>ratio</b> control knob	Compressor ratio
7	<b>MODE</b> pushbutton	Compressor mode: corrective, adaptive, creative or vintage
8	<b>KNEE</b> pushbutton	Compressor knee: hard, medium or soft
9	<b>IN</b> switch	Compressor sidechain in/out
10	<b>freq</b> control knob	Compressor sidechain frequency
11	<b>WIDTH</b> pushbutton	Compressor sidechain: 2 Oct, 1 Oct or 0.3 Oct

Gates

The following diagram shows the input channel gate parameters copied through scenes.

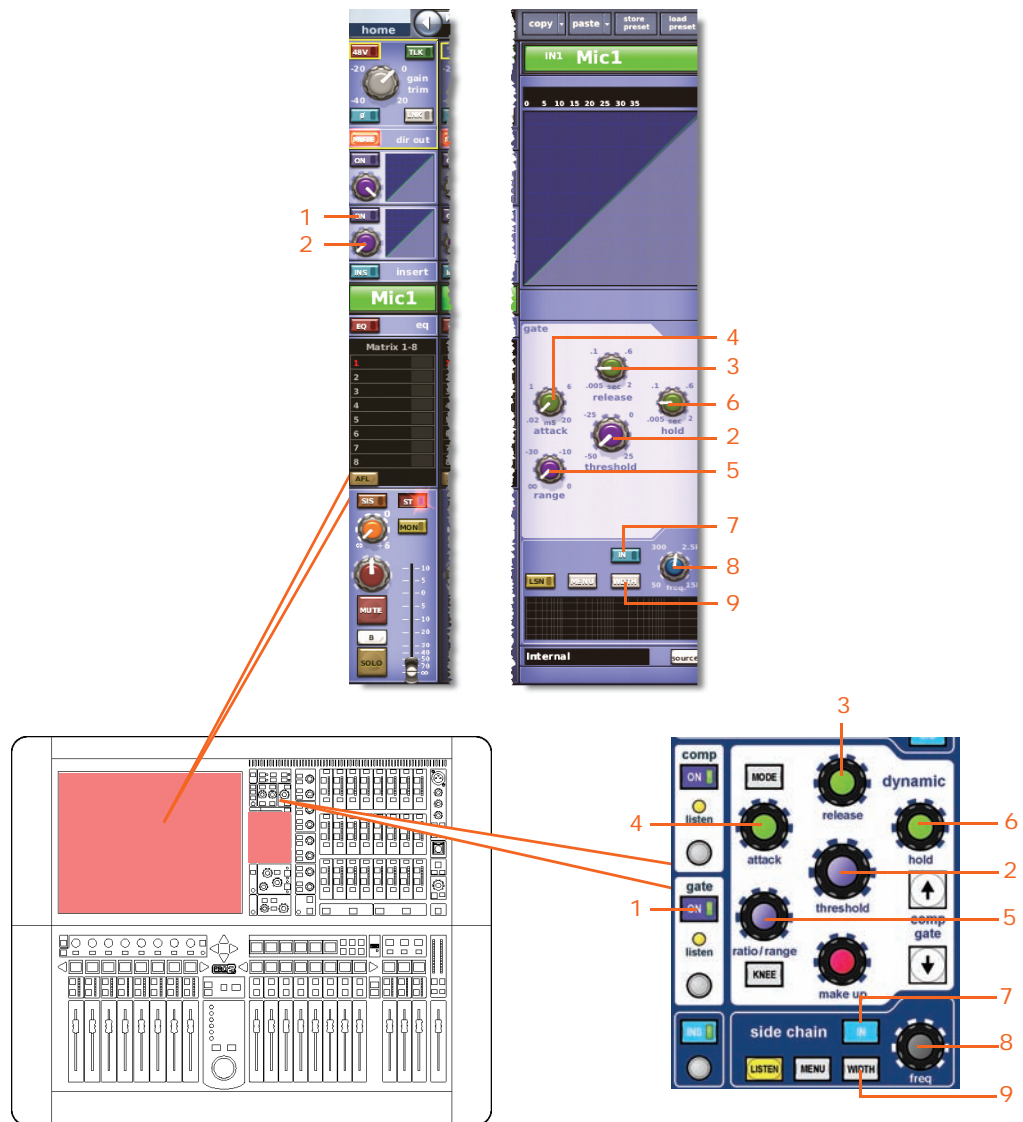

Item	Control	Parameter
1	<b>ON</b> switch	Gate on/off
2	<b>threshold</b> control knob	Gate threshold
3	<b>release</b> control knob	Gate release
4	<b>attack</b> control knob	Gate attack
5	<b>range</b> control knob	Gate range
6	<b>hold</b> control knob	Gate hold
7	<b>IN</b> switch	Gate sidechain in/out
8	<b>freq</b> control knob	Gate sidechain frequency
9	<b>WIDTH</b> pushbutton	Gate sidechain width: 2 Oct, 1 Oct or 0.3 Oct

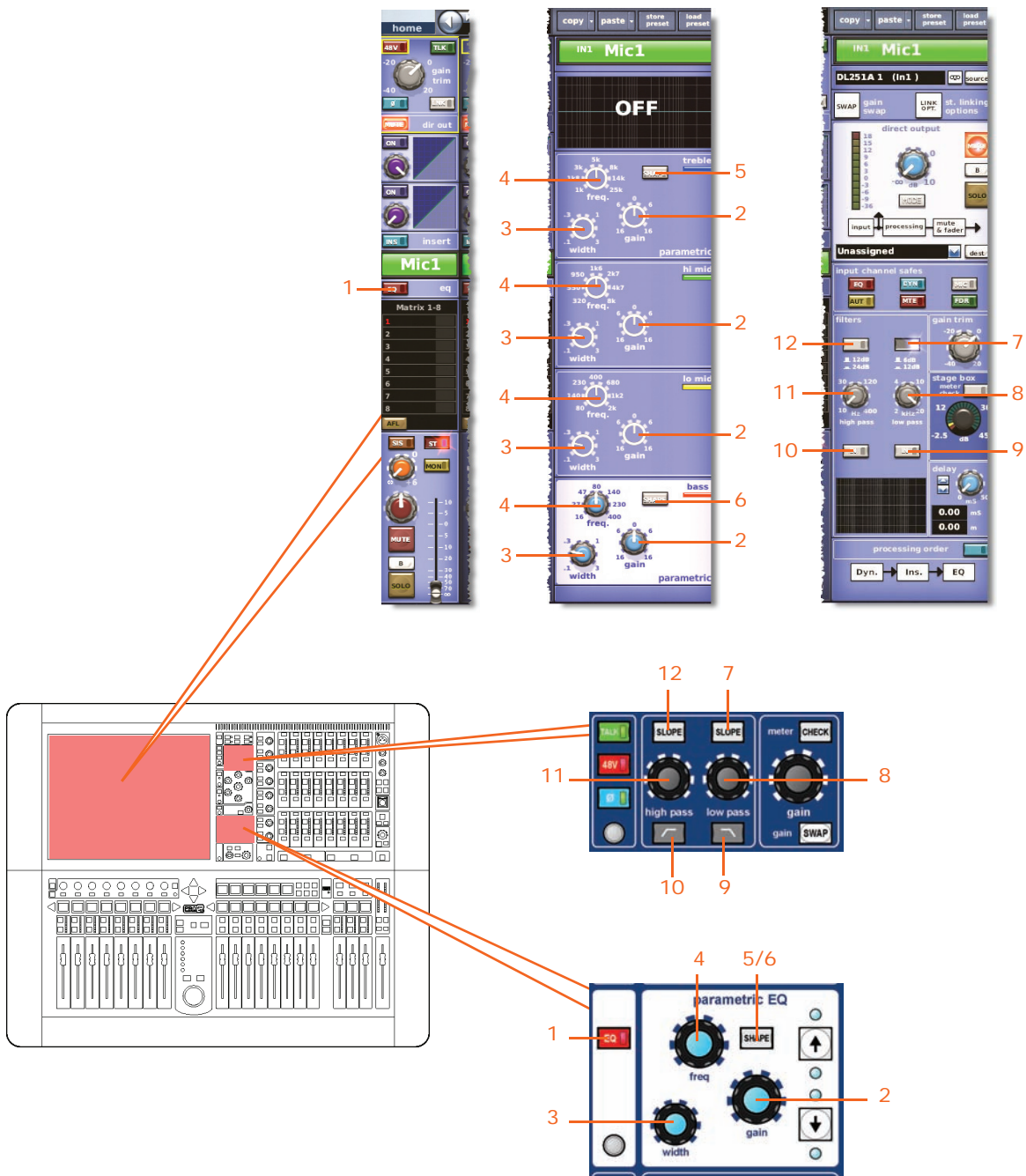

EQs

The following diagram shows the EQ parameters copied through scenes.



Item	Control	Parameter
1	EQ switch	EQ on/off
2	gain control knob	EQ gain level
3	width control knob	EQ width
4	freq control knob	EQ frequency
5	SHAPE switch	Treble: parametric, bright, classic or soft

---

<i>Item</i>	<i>Control</i>	<i>Parameter</i>
6	<b>SHAPE</b> switch	Bass: parametric, deep, classic or warm
7	<b>SLOPE</b> pushbutton	Low pass filter slope 6dB or 12dB
8	<b>low pass</b> control knob	Low pass filter frequency
9	 /[IN] switch	Low pass filter in/out
10	 /[IN] switch	High pass filter in/out
11	<b>high pass</b> control knob	High pass filter frequency
12	<b>SLOPE</b> pushbutton	High pass filter slope 12dB or 24dB

---



**Aux Sends (1 to 16)**

This section shows the parameters of the mix sections copied through scenes.

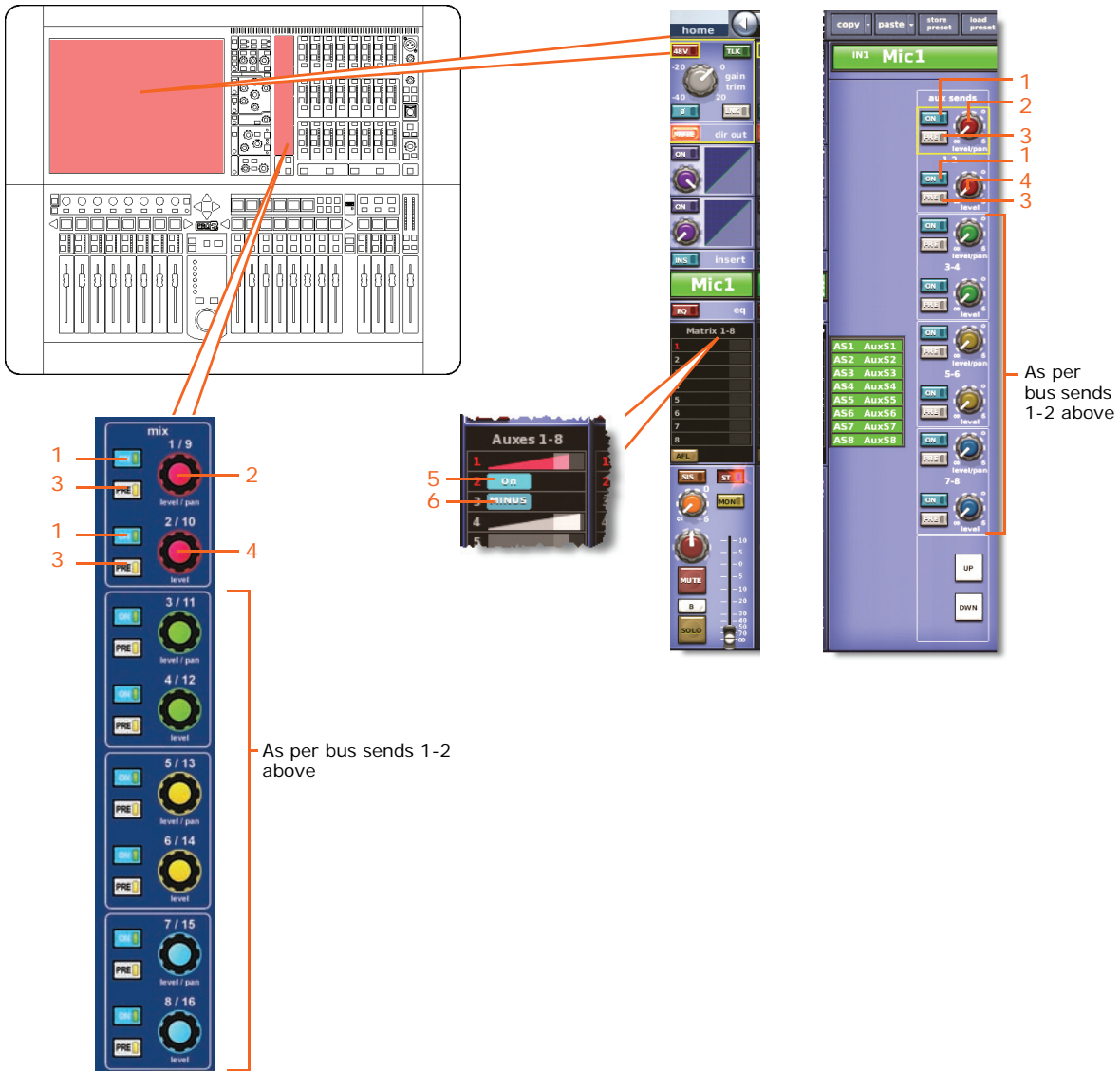

**Note:** Only aux sends 1 to 8 are shown above, but this is typically the same for all of the 16 aux sends.

Item	Control	Parameter
1	ON switch	Bus send on/off
2	level/pan control knob	Bus level, or pan when bus is linked
3	PRE switch	Pre-fader on/off
4	level control knob	Bus level
5	On switch	Aux bus send on/off — only available when aux bus is in group mode
6	MUTE switch	Aux bus send mute on/off — only available when aux bus is in mix minus mode



**Matrix Sends (1 to 8)**

This section shows the parameters of the mix sections copied through scenes.

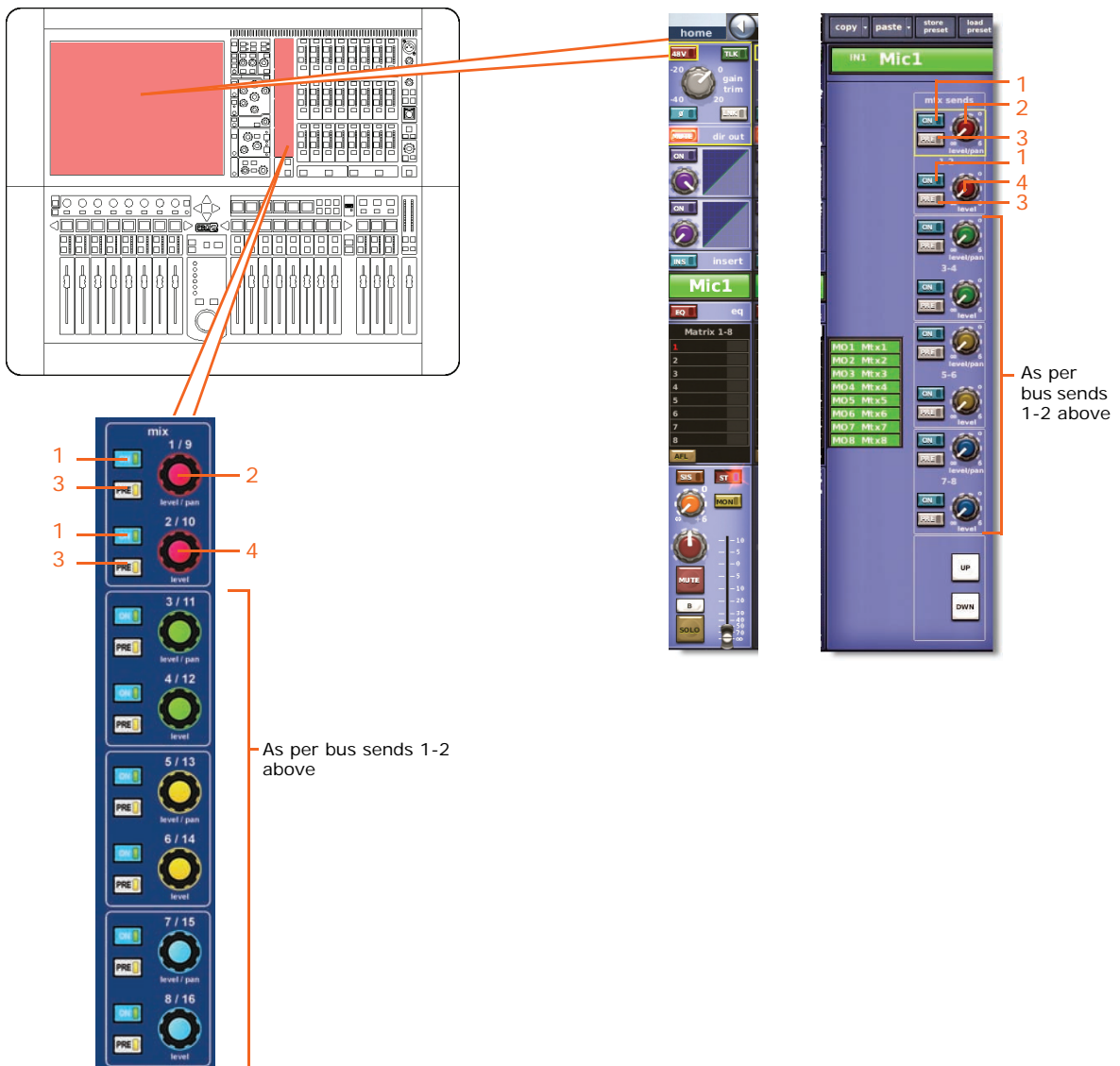

<i>Item</i>	<i>Control</i>	<i>Parameter</i>
1	<b>ON</b> switch	Bus send on/off
2	<b>level/pan</b> control knob	Bus level, or pan when bus is linked
3	<b>PRE</b> switch	Pre-fader on/off
4	<b>level</b> control knob	Bus level

Fader Sections

This section shows all the parameters of the master routing that are copied through scenes.

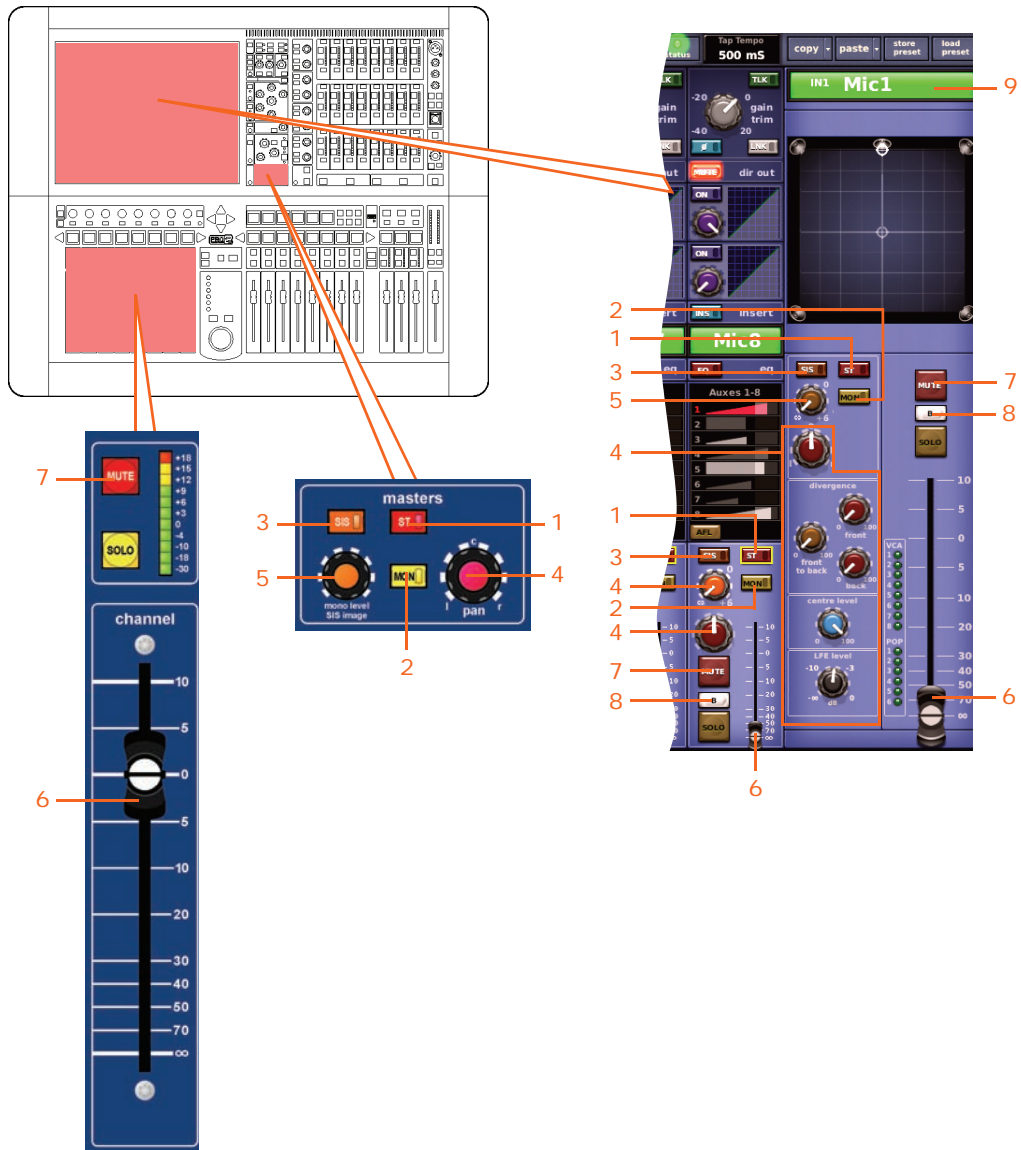

Item	Control	Parameter
1	ST switch	Stereo on/off
2	MON switch	Mono on/off
3	SIS switch	Spatial imaging system on/off
4	Panning control knobs	Surround panning (includes all surround sound parameters)
5	mono level/SIS image control knob	Mono level (SIS off) or SIS image (SIS on)
6	Fader	Level
7	MUTE switch	Mute on/off

Item	Control	Parameter
8	B button	Solo B in/out
9	Field	Channel name

**Recall Scope**

See "Inputs" on page 339.

**Store Scope**

See "Inputs" on page 339.

**Routing**

The following diagram shows the input channel routing parameters copied through scenes.

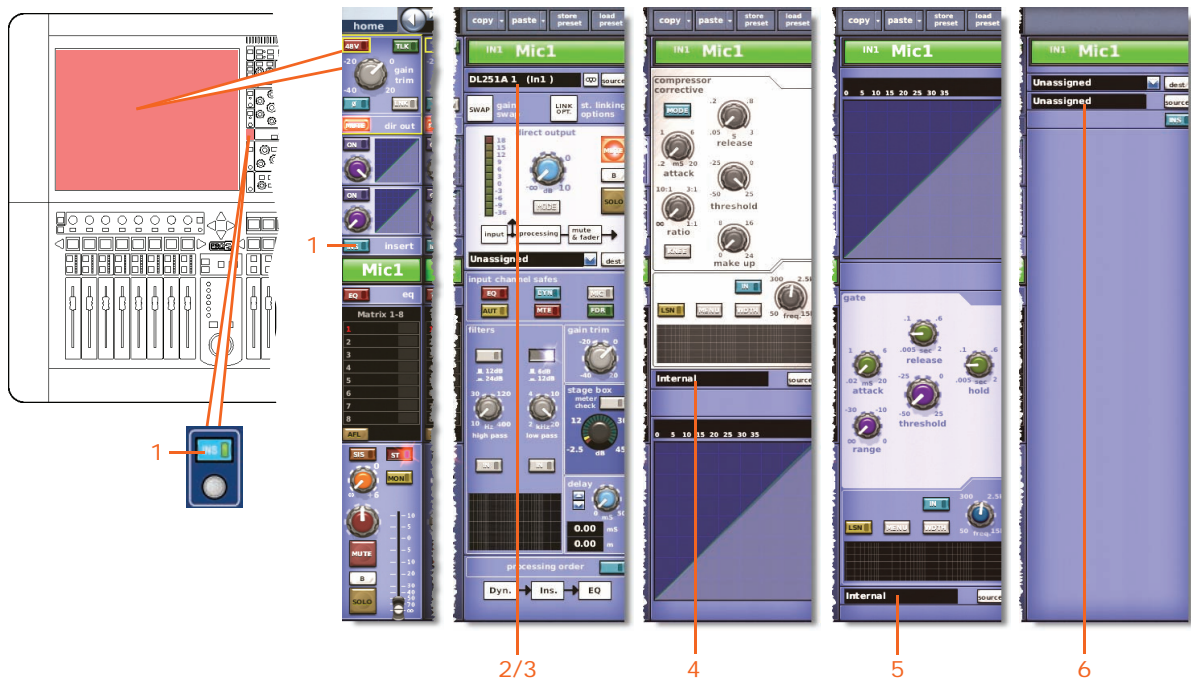

Item	Control	Parameter
1	INS switch	Insert in/out
2	Field	Primary input source
3	Field	Tape input source
4	Field	Compressor sidechain source*
5	Field	Gate key source*
6	Field	Insert return source*

\* Only automated when automate patching is on.

## Aux Returns (return channels)

This section shows you which parameters for each of the eight return channels are affected by copy through scenes.

### Config sections

The following diagram shows the parameters of the configuration detail area copied through scenes.

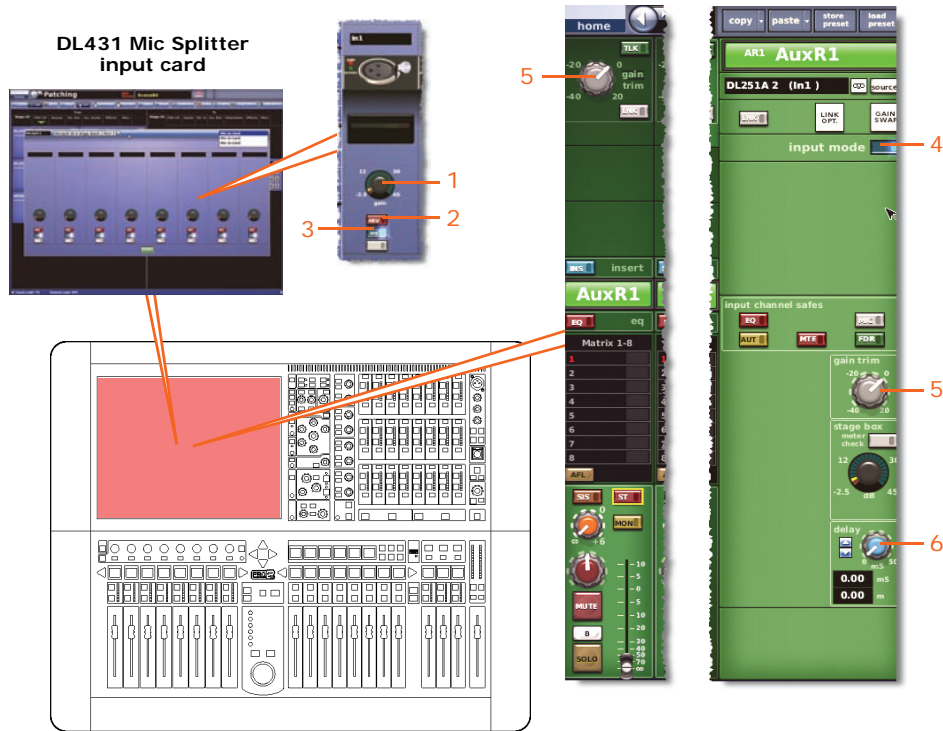

Item	Control	Parameter
1	Stage box control knob	Remote amplifier level*
2	48V switch	48V phantom voltage on/off*
3	Flt switch	30Hz filter in/out*
5	input zone switch	Input zone in/out

### Comp./Output Dyn

Not applicable.

### Gates

Not applicable.

EQs

The following diagram shows the EQ parameters copied through scenes.

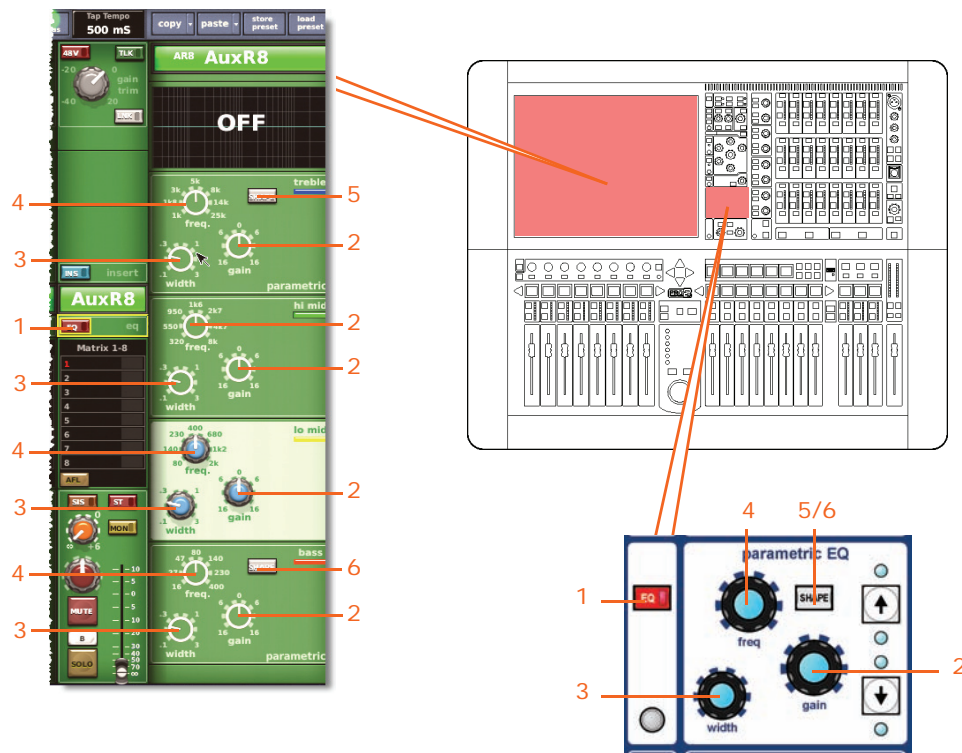

Item	Control	Parameter
1	EQ switch	EQ on/off
2	gain control knob	EQ gain level
3	width control knob	EQ width
4	freq control knob	EQ frequency
5	SHAPE switch	Treble: parametric, bright, classic or soft

**Aux Sends (1 to 16)**

The following diagram shows the parameters of the mix detail area copied through scenes.

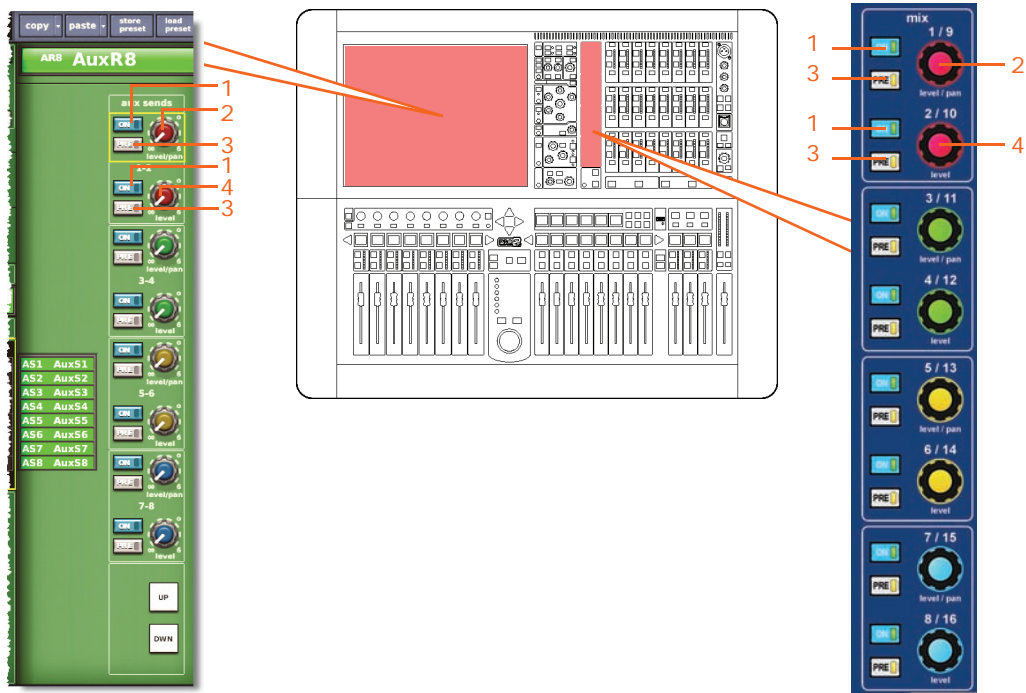

**Note:** Although only aux sends 1-2 are referenced above, this also applies to all 16 aux sends.

Item	Control	Parameter
1	ON switch	Matrix bus send on/off
2	level/pan control knob	Bus level, or pan when bus is linked
3	PRE switch	Pre-fader on/off
4	level control knob	Bus level



**Matrix Sends (1 to 8)**

The following diagram shows the parameters of the mix detail area copied through scenes.

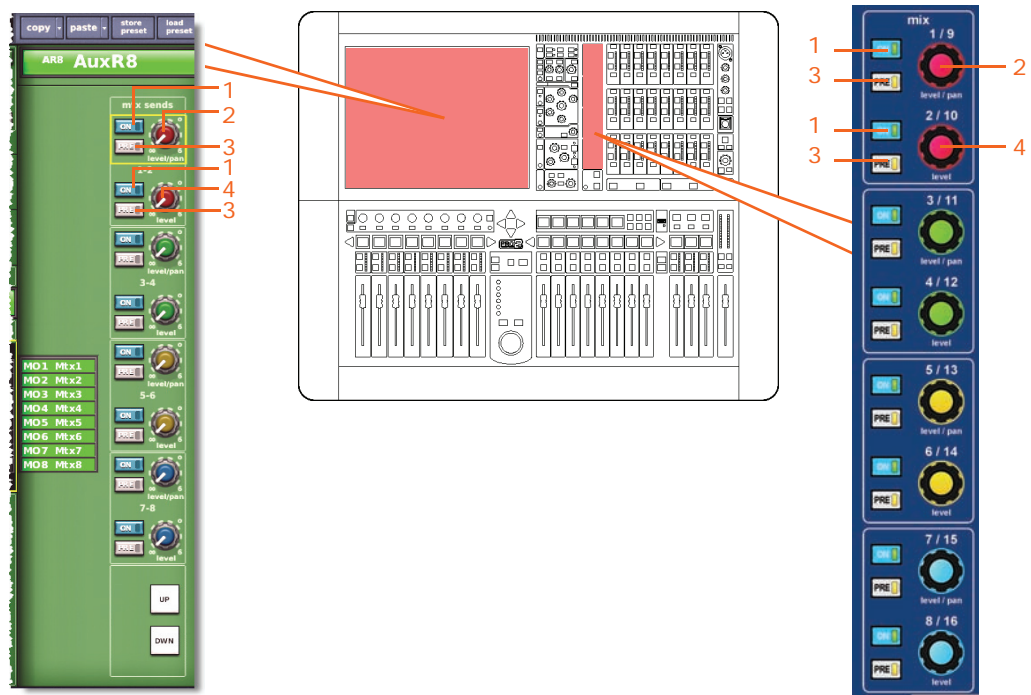

**Note:** Although only matrix sends 1-2 are referenced above, this also applies to all eight matrix sends.

Item	Control	Parameter
1	ON switch	Matrix bus send on/off
2	level/pan control knob	Bus level, or pan when bus is linked
3	PRE switch	Pre-fader on/off
4	level control knob	Bus level

Fader Sections

The following diagram shows the parameters of the master routing detail area copied through scenes.

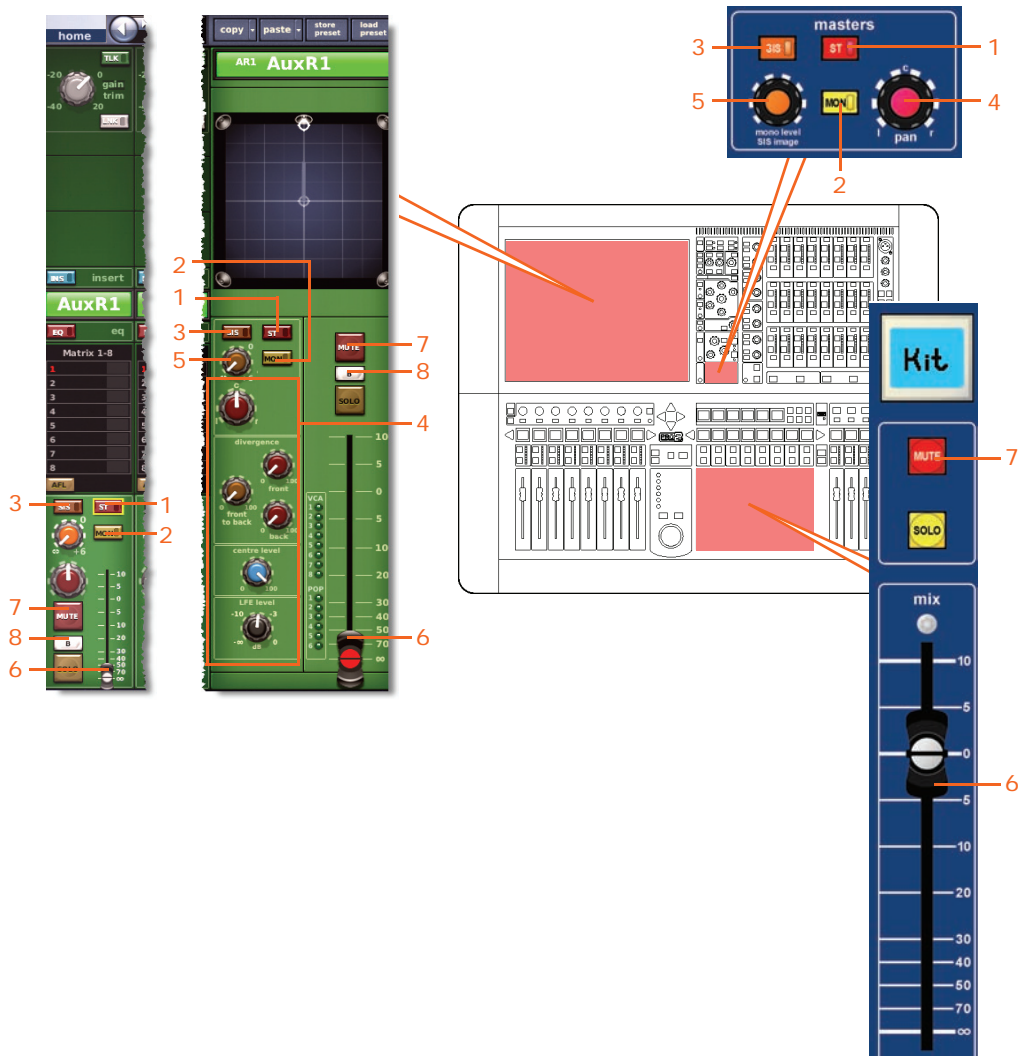

Item	Control	Parameter
1	ST switch	Stereo on/off
2	MON switch	Mono on/off
3	SIS switch	Spatial imaging system on/off
4	Panning control knobs	Surround panning (includes all surround sound parameters)
5	mono level/SIS image control knob	Mono level (SIS off) or SIS image (SIS on)
6	Fader	Level
7	MUTE switch	Mute on/off
8	B switch	Solo B in/out



**Recall Scope**

For details, see “Returns (Aux Returns)” on page 350.

**Store Scope**

For details, see “Returns (Aux Returns)” on page 350.

**Routing**

The following diagram shows the return channel routing parameters copied through scenes.

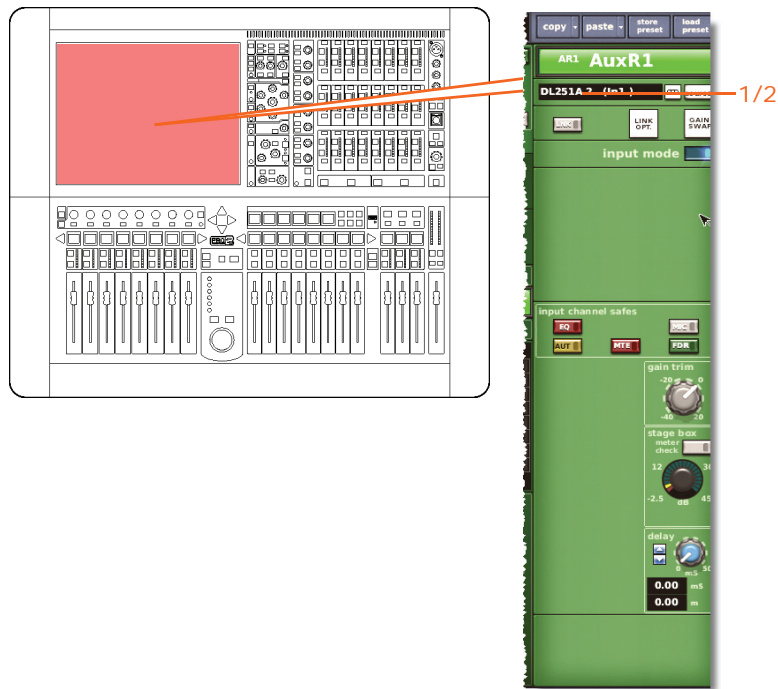

<i>Item</i>	<i>Control</i>	<i>Parameter</i>
1	Field	Primary input source
2	Field	Tape input source

## Aux Sends (aux channels)

This section shows you which parameters for each of the 32 aux channels are affected by copy through scenes.

### Config sections

The following diagram shows the parameters of the configuration detail area copied through scenes.

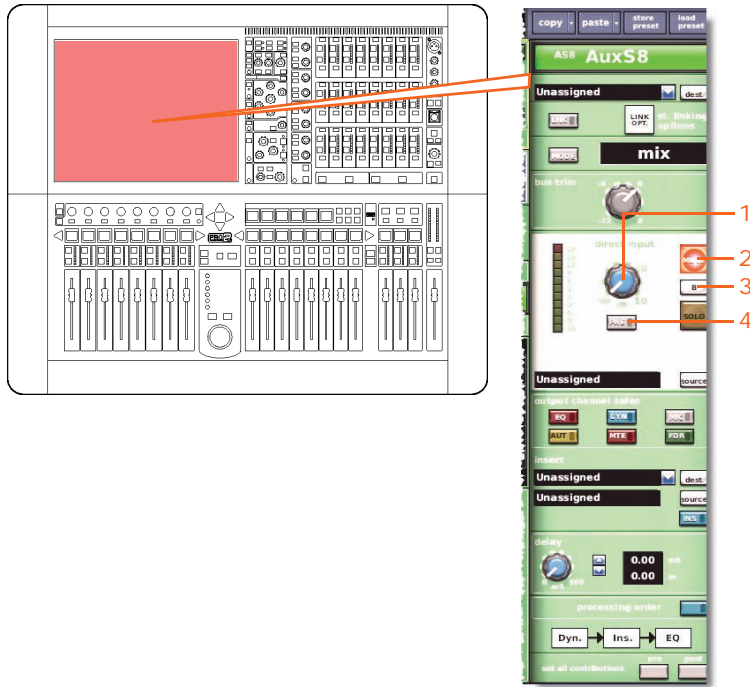

<i>Item</i>	<i>Control</i>	<i>Parameter</i>
1	level control knob	Direct input level
2	MUTE switch	Direct input mute on/off
3	SOLO B/[B] switch	Direct input solo B in/out
4	MODE/[PRE] switch	Direct input pre- in/out

Comp./Output Dyn

The following diagram shows the parameters of the compressor detail area copied through scenes. Only corrective compressor shown below, but typically the same for the other compressor modes.

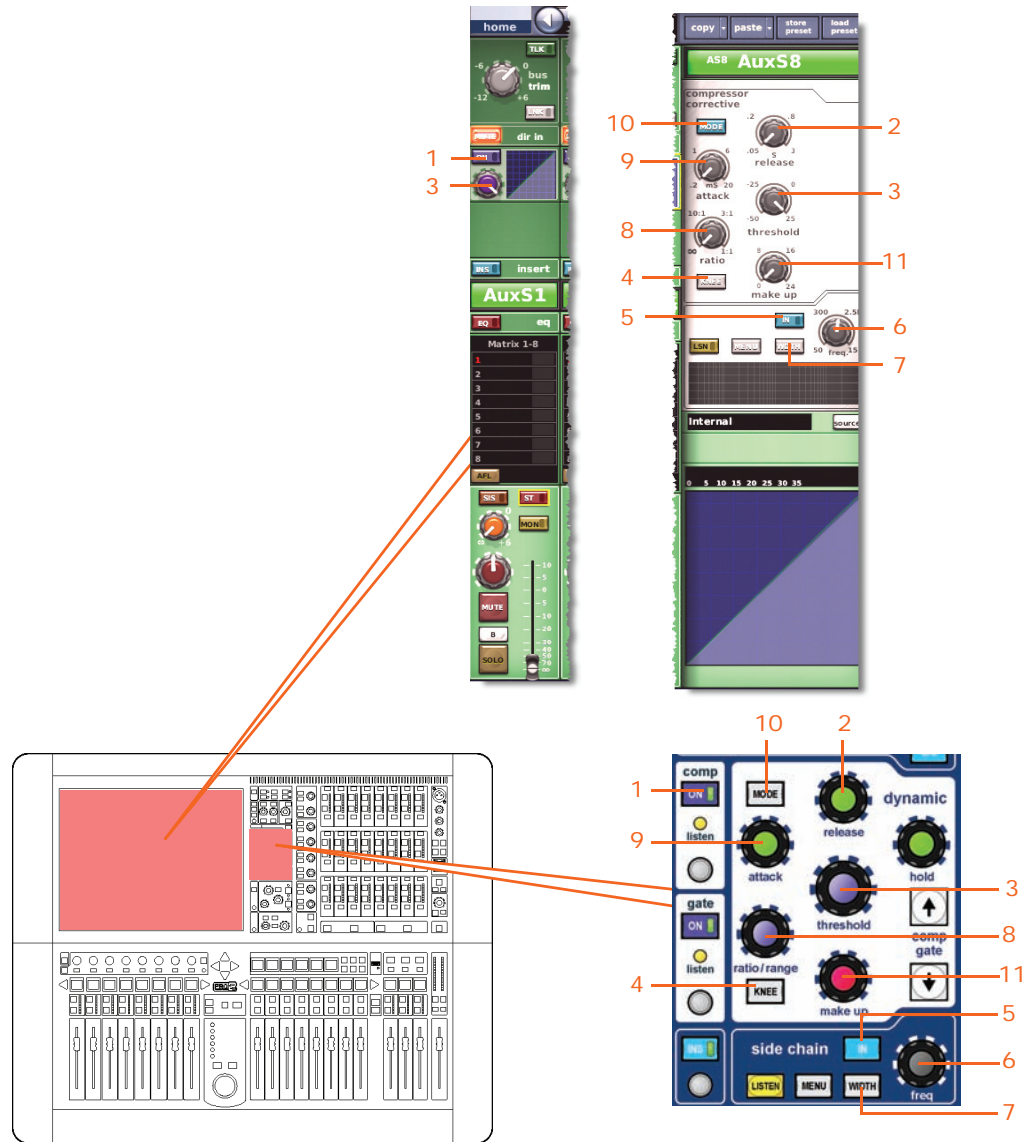

Item	Control	Parameter
1	<b>ON</b> switch	Compressor on/off
2	<b>release</b> control knob	Compressor release
3	<b>threshold</b> control knob	Compressor threshold
4	<b>KNEE</b> pushbutton	Compressor knee: hard, medium or soft
5	<b>IN</b> switch	Compressor sidechain in/out
6	<b>freq</b> control knob	Compressor sidechain frequency
7	<b>WIDTH</b> pushbutton	Compressor sidechain width: 2 Oct, 1 Oct or 0.3 Oct

<i>Item</i>	<i>Control</i>	<i>Parameter</i>
8	<b>ratio</b> control knob	Compressor ratio
9	<b>attack</b> control knob	Compressor attack
10	<b>MODE</b> pushbutton	Compressor mode: corrective, adaptive, creative, vintage or shimmer
11	<b>make up</b> control knob	Compressor gain

---

## Gates

Not applicable.

EQs

The following diagram shows the EQ parameters copied through scenes.

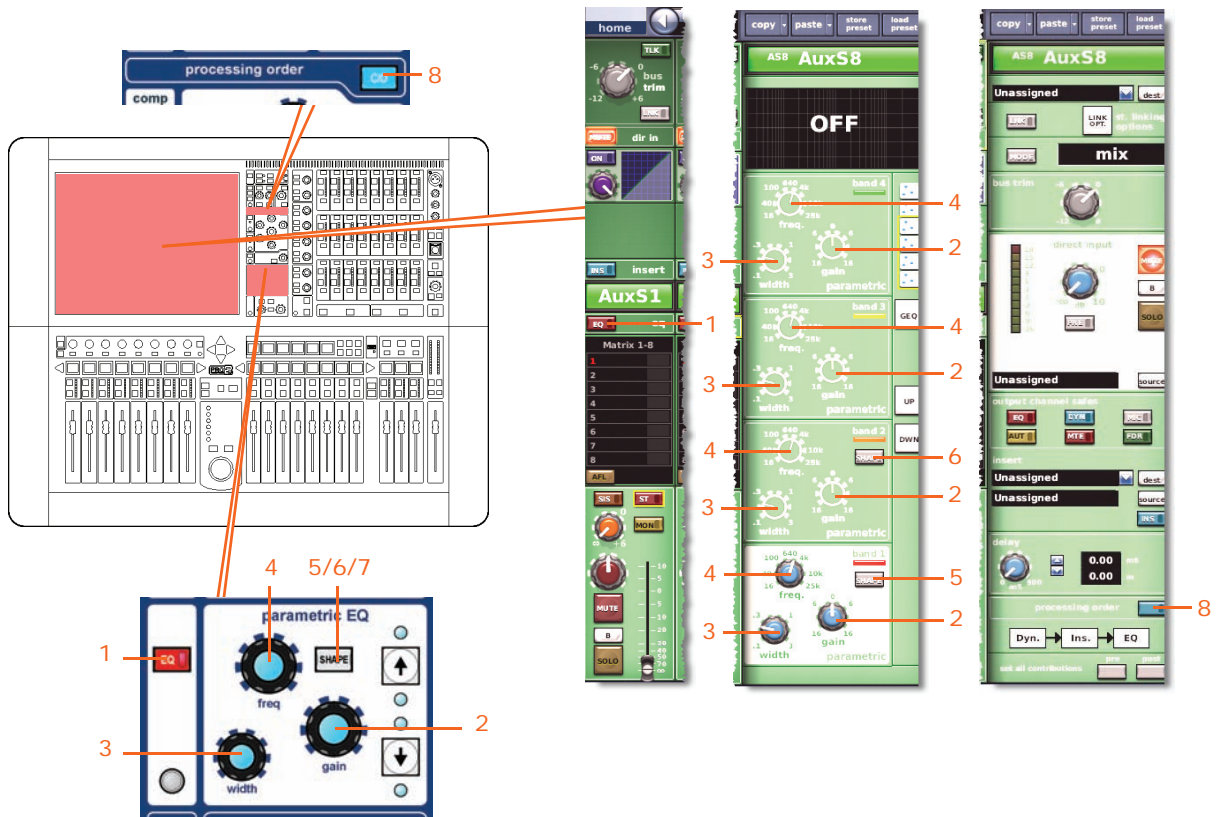

Item	Control	Parameter
1	EQ switch	EQ on/off
2	gain control knob	EQ gain level
3	width control knob	EQ width
4	freq control knob	EQ frequency
5	SHAPE switch	Band 1 shelving mode: parametric, warm, high pass 6dB or high pass 12dB. (This band is not available if band 2 is selected as high pass 24dB.)
6	SHAPE switch	Band 2 shelving mode: parametric or high pass 24dB
7*	SHAPE switch	Band 6 shelving mode: parametric, soft, low pass 6dB or low pass 12dB
8	C/O switch	Order of processing: <b>Dyn.</b> → <b>Ins.</b> → <b>EQ</b> or <b>EQ</b> → <b>Ins.</b> → <b>Dyn.</b>

\* Not shown in diagram.

**Note:** Although bands 5 and 6 are not shown above, the items in the table also apply. Both bands have items 2, 3 and 4, and band 6 also has item 7.

Aux Sends (1 to 16)

Not applicable.

**Matrix Sends (1 to 8)**

The following diagram shows the parameters of the mix detail area copied through scenes.

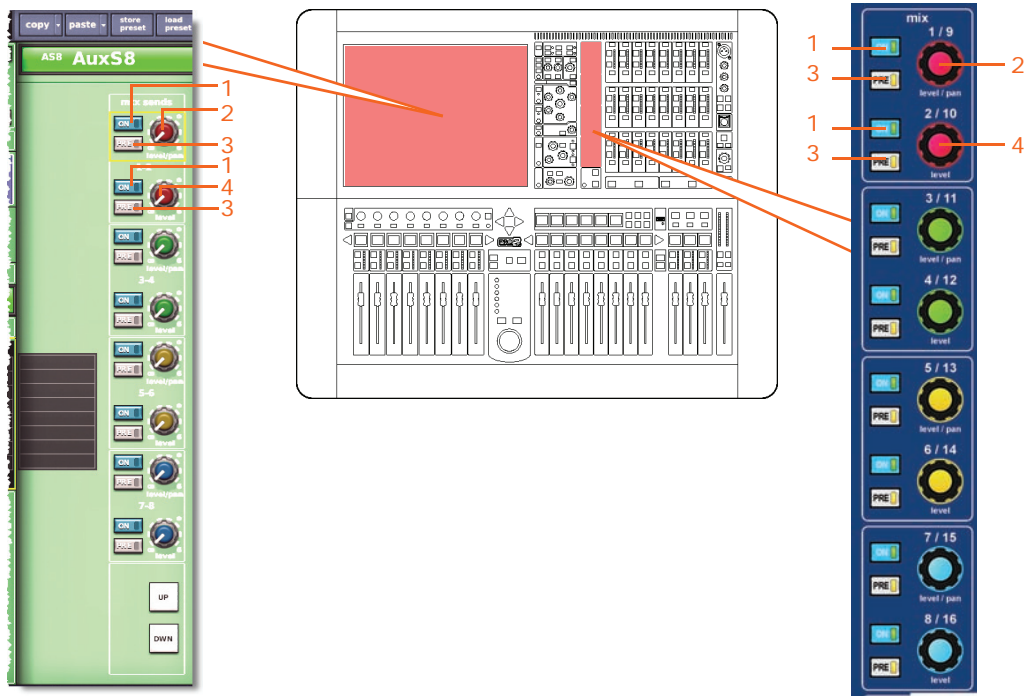

**Note:** Although only matrix sends 1-2 are referenced above, this also applies to all eight matrix sends.

<i>Item</i>	<i>Control</i>	<i>Parameter</i>
1	<b>ON</b> switch	Matrix bus send on/off
2	<b>level/pan</b> control knob	Bus level, or pan when bus is linked
3	<b>PRE</b> switch	Pre-fader on/off
4	<b>level</b> control knob	Bus level

Fader Sections

The following diagram shows the parameters of the master routing detail area copied through scenes.

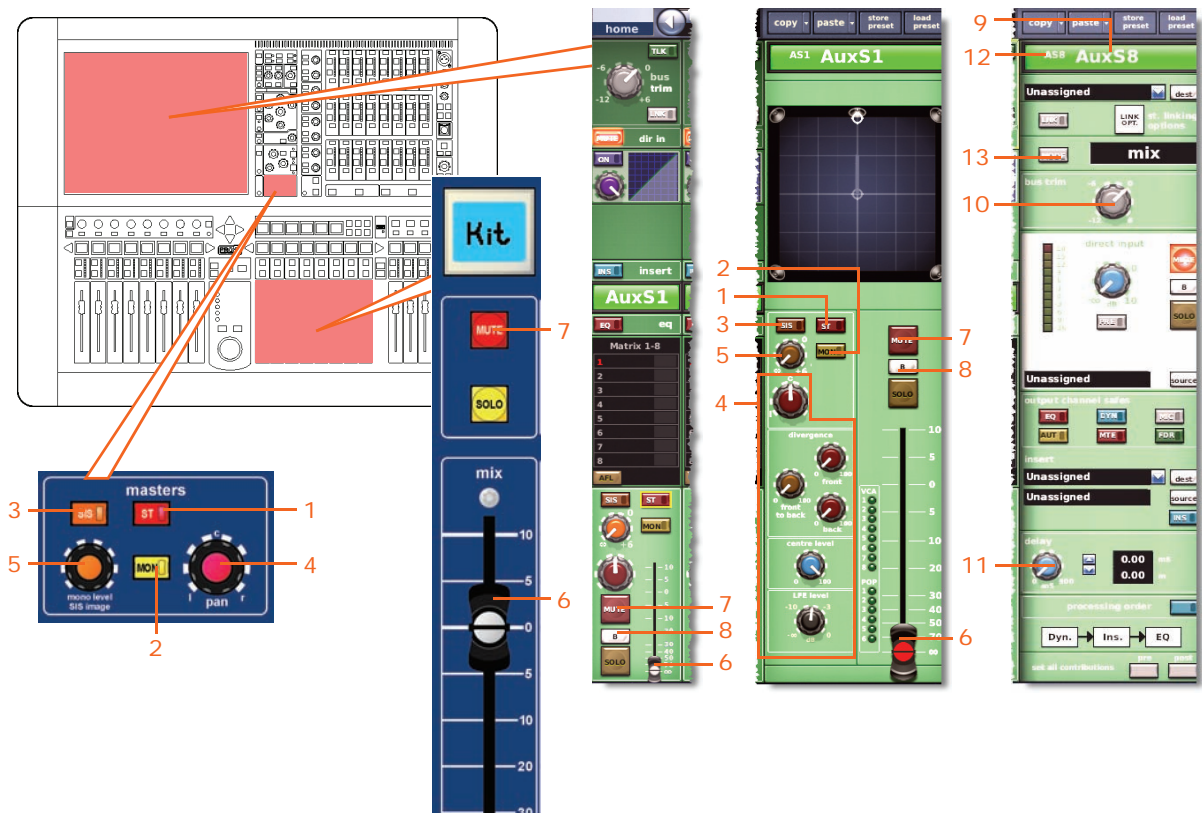

Item	Control	Parameter
1	<b>ST</b> switch	Stereo on/off
2	<b>MON</b> switch	Mono on/off
3	<b>SIS</b> switch	Spatial imaging system on/off
4	Panning control knobs	Surround panning (includes all surround sound parameters)
5	<b>mono level/SIS image</b> control knob	Mono level (SIS off) or SIS image (SIS on)
6	Fader	Level
7	<b>MUTE</b> switch	Mute on/off
8	<b>SOLO B/[B]</b> switch	Solo B in/out
9	Field	Channel name
10	<b>bus trim</b> control knob	Bus trim level
11	<b>delay</b> control knob	Delay time
12	Field	Channel colour
13	<b>MODE</b> button	Bus mode

**Recall Scope**

For details, see “Auxes (Aux Sends)” on page 356.

**Store Scope**

For details, see “Auxes (Aux Sends)” on page 356.

**Routing**

The following diagram shows the aux channel routing parameters copied through scenes.

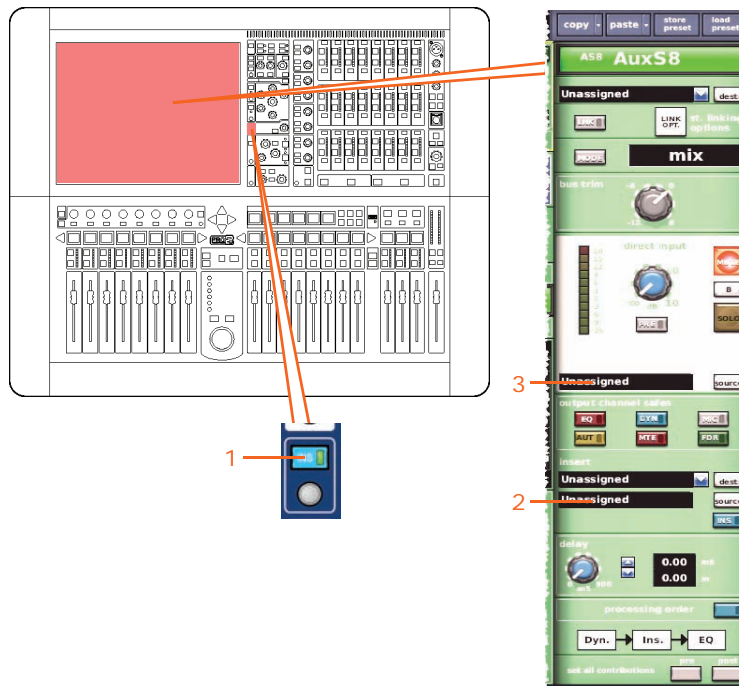

<i>Item</i>	<i>Control</i>	<i>Parameter</i>
1	INS switch	Insert in/out
2	Field	Insert return source*
3	Field	Direct input source*

\* Only automated when automate patching is on.



## Matrix (matrix channels)

This section shows you which parameters for each of the eight matrix channels are affected by copy through scenes.

### Config sections

The following diagram shows the parameters of the configuration detail area copied through scenes.

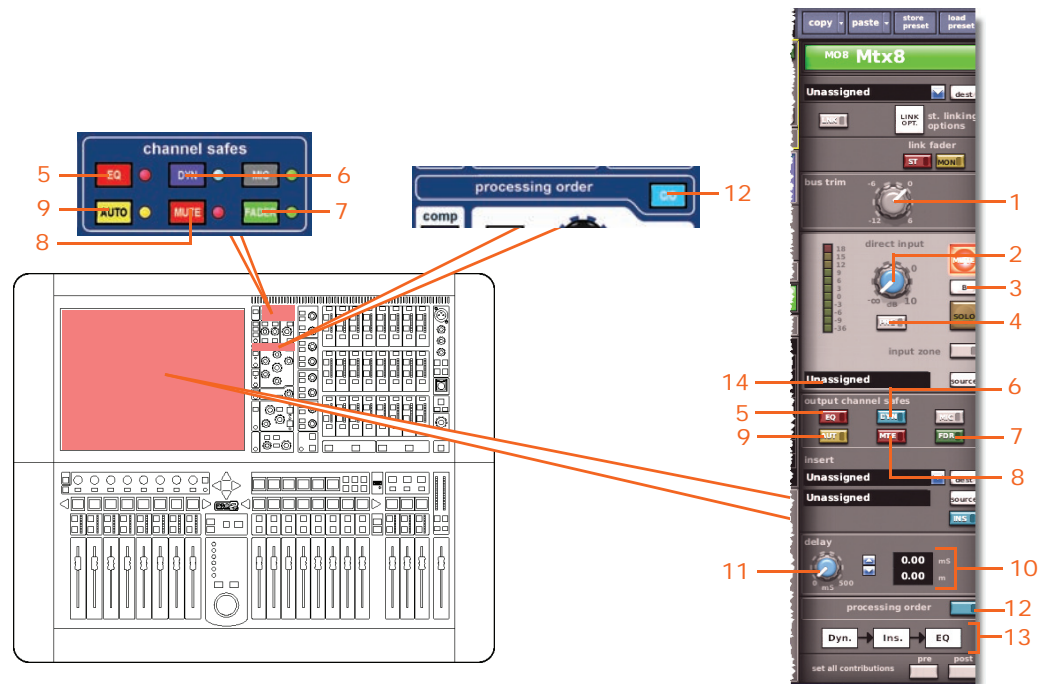

Item	Control	Parameter
1	bus trim control knob	Bus trim level
2	level control knob	Direct input level
3	SOLO B/[B] switch	Direct input solo B on/off
4	MODE/[PRE] switch	Direct input pre- in/out
5	EQ pushbutton	EQ safe on/off
6	DYN pushbutton	Dynamic safe on/off
7	FADER/[FDR] switch	Fader safe on/off
8	MUTE/[MTE] switch	Mute safe on/off
9	AUTO/[AUT] switch	Auto safe on/off
10	Delay field	Delay in milliseconds (ms) and metres (m)
11	delay control knob	Delay level
12	C/O switch	Order of processing: <b>Dyn.</b> → <b>Ins.</b> → <b>EQ</b> or <b>EQ</b> → <b>Ins.</b> → <b>Dyn.</b>

Item	Control	Parameter
13	Graphic	Order of processing
14	Field	Direct input source

**Comp./Output Dyn**

The following diagram shows the parameters of the compressor detail area copied through scenes. Only corrective compressor shown below, but typically the same for the other compressor modes.

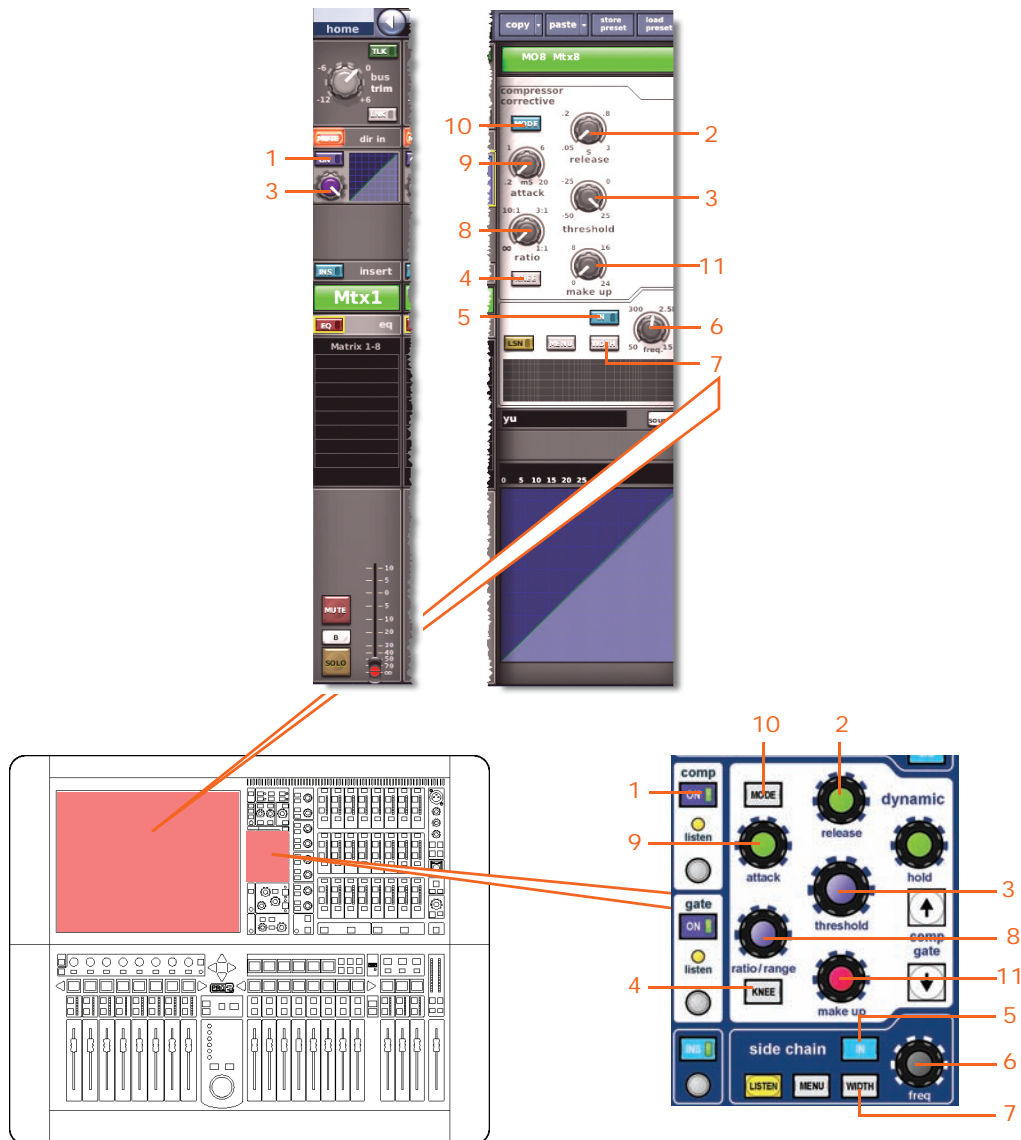

Item	Control	Parameter
1	<b>ON</b> switch	Compressor on/off
2	<b>release</b> control knob	Compressor release
3	<b>threshold</b> knob	Compressor threshold

---

<i>Item</i>	<i>Control</i>	<i>Parameter</i>
4	<b>KNEE</b> pushbutton	Compressor knee: hard, medium or soft
5	<b>IN</b> switch	Compressor sidechain in/out
6	<b>freq</b> control knob	Compressor sidechain frequency
7	<b>WIDTH</b> pushbutton	Compressor sidechain width: 2 Oct, 1 Oct or 0.3 Oct
8	<b>ratio</b> control knob	Compressor ratio
9	<b>attack</b> control knob	Compressor attack
10	<b>MODE</b> pushbutton	Compressor mode: corrective, adaptive, creative, vintage or shimmer
11	<b>make up</b> control knob	Compressor gain

---

### Gates

Not applicable.

EQs

The following diagram shows the parameters of the EQ detail area copied through scenes.

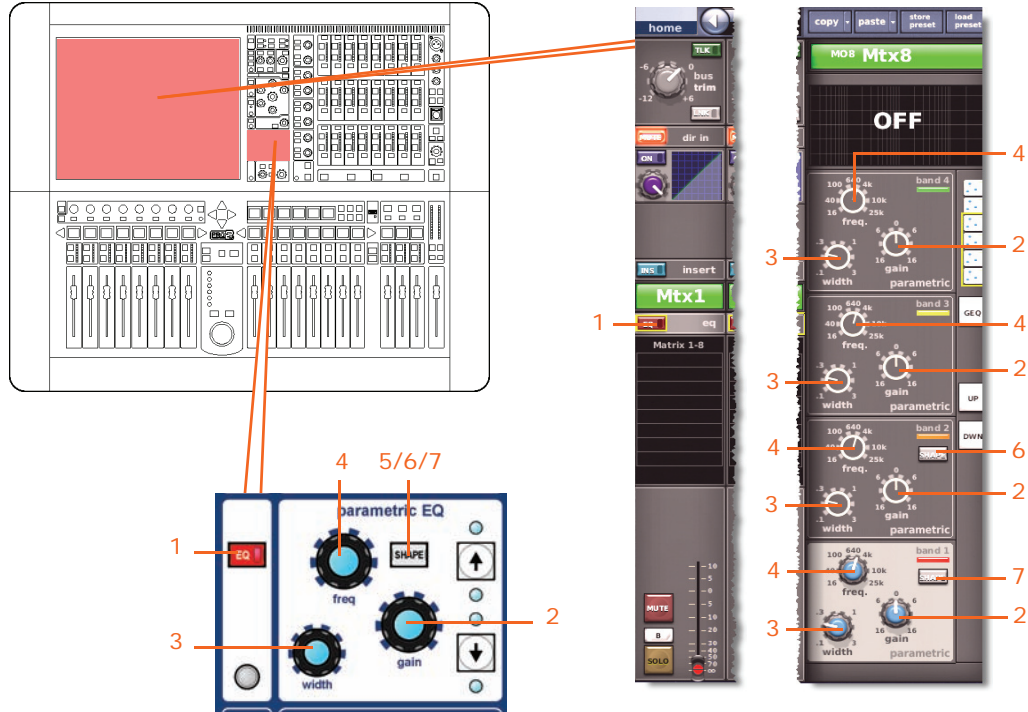

Item	Control	Parameter
1	EQ switch	EQ on/off
2	gain control knob	EQ gain level
3	width control knob	EQ width
4	freq control knob	EQ frequency
5*	SHAPe switch	Band 6 shelving mode: parametric, soft, low pass 6dB or low pass 12dB
6	SHAPe switch	Band 2 shelving mode: parametric or high pass 24dB
7	SHAPe switch	Band 1 shelving mode: parametric, warm, high pass 6dB or high pass 12dB. (This band is not available if band is selected as high pass 24dB.)

\* Not shown in diagram.

**Note:** Although bands 5 and 6 are not shown above, the items in the table also apply. Both bands have items 2, 3 and 4, and band 6 also has item 7.

Aux Sends (1 to 16)

Not applicable.

Matrix Sends (1 to 8)

Not applicable.

Fader Sections

The following diagram shows the parameters of the master routing detail area copied through scenes.

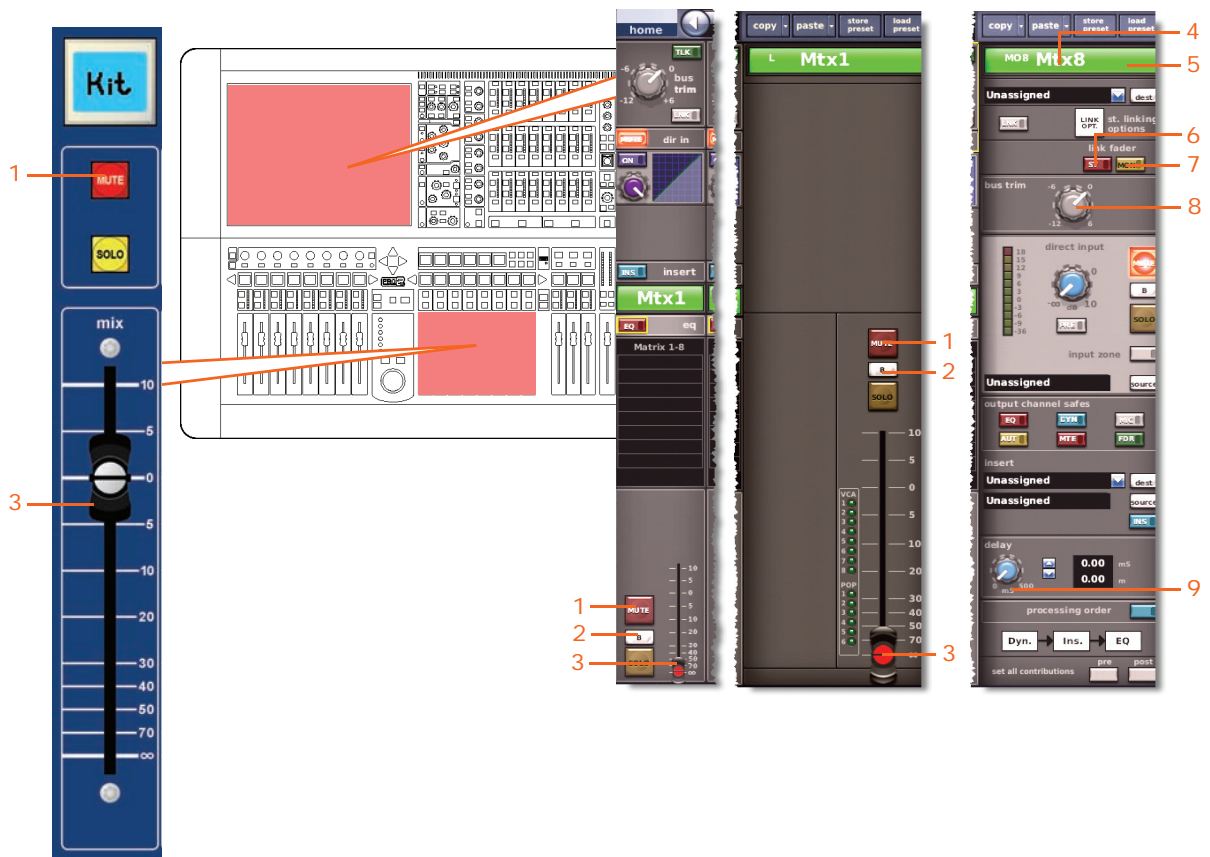

Item	Control	Parameter
1	<b>MUTE</b> switch	Mute on/off
2	<b>B</b> switch	Solo B in/out
3	Fader	Level
4	Field	Channel name
5	Field	Channel colour
6	<b>ST</b> switch	Link to stereo master fader
7	<b>MON</b> switch	Link to mono master fader
8	<b>bus trim</b> control knob	Bus trim level
9	<b>delay</b> control knob	Delay time

**Recall Scope**

For details, see “Matrices” on page 363.

**Store Scope**

For details, see “Matrices” on page 363.

**Routing**

The following diagram shows the matrix channel routing parameters copied through scenes.

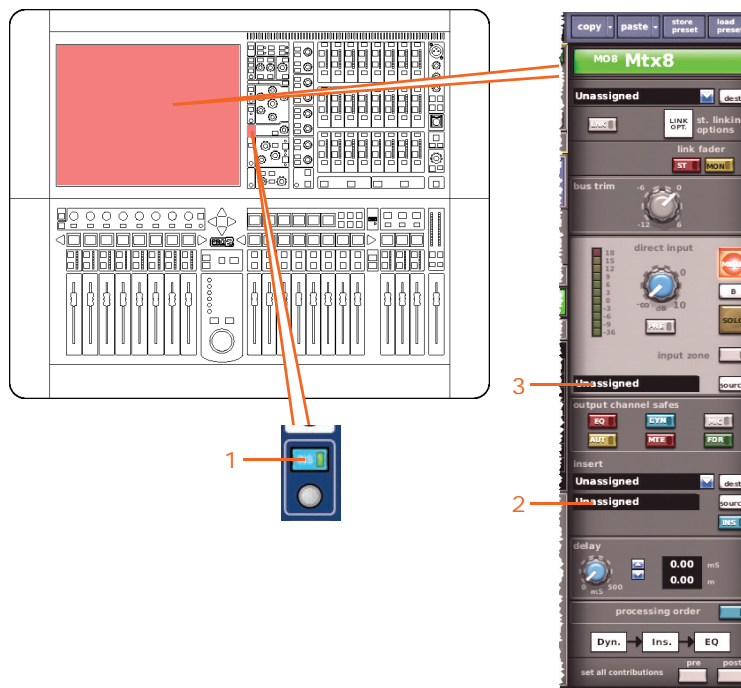

<i>Item</i>	<i>Control</i>	<i>Parameter</i>
1	INS switch	Insert in/out
2	Field	Insert return source*
3	Field	Direct input source*

\* Only automated when automate patching is on.

## GEQs

You can copy the control settings of any of the GEQs through scenes. Only the **Recall Scope** and **Store Scope** options in the **Sections** area of the **Show Editor** screen are applicable to this option.

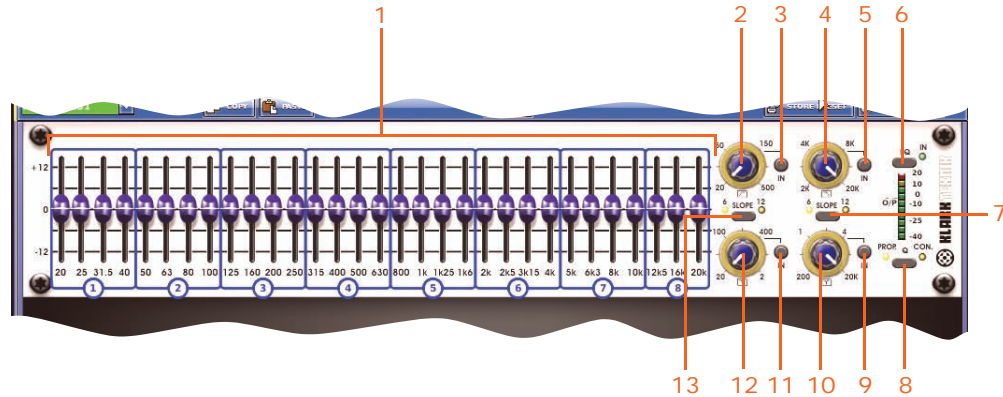

Item	Control	Parameter
1	31 faders	Fader positions
2	High pass filter control knob	High pass filter cut off frequency
3	IN switch	High pass filter in/out
4	Low pass filter control knob	Low pass filter cut off frequency
5	IN switch	Low pass filter in/out
6	EQ switch	EQ in/out
7	SLOPE switch	Low pass filter: 6dB or 12dB
8	Q switch	Q mode as proportional ( <b>PROP.</b> ) or constant ( <b>CON.</b> )
9	IN switch	200Hz - 20kHz notch filter in/out
10	Notch filter control knob	200Hz - 20kHz notch filter frequency
11	IN switch	20Hz - 2kHz notch filter in/out
12	Notch filter control knob	20Hz - 2kHz notch filter frequency
13	SLOPE switch	High pass filter: 6dB or 12dB

## Effects

With only the internal effects unit(s) selected, the unit type and control settings of the desired effect(s) are copied through scenes. In addition, if the **Routing** option (**Sections** area of the **Show Editor** screen) is selected, the input patching is also copied through scenes.

## VCA/POPulation (groups)

You can copy the group membership allocation of the VCA and Groups through scenes. None of the options in the **Sections** area are applicable to this option.

## Masters (master channels)

This section shows you which parameters for each of the three master channels (mono and stereo left and stereo right) are affected by copy through scenes.

### Config sections

The following diagram shows the parameters of the configuration detail area copied through scenes.

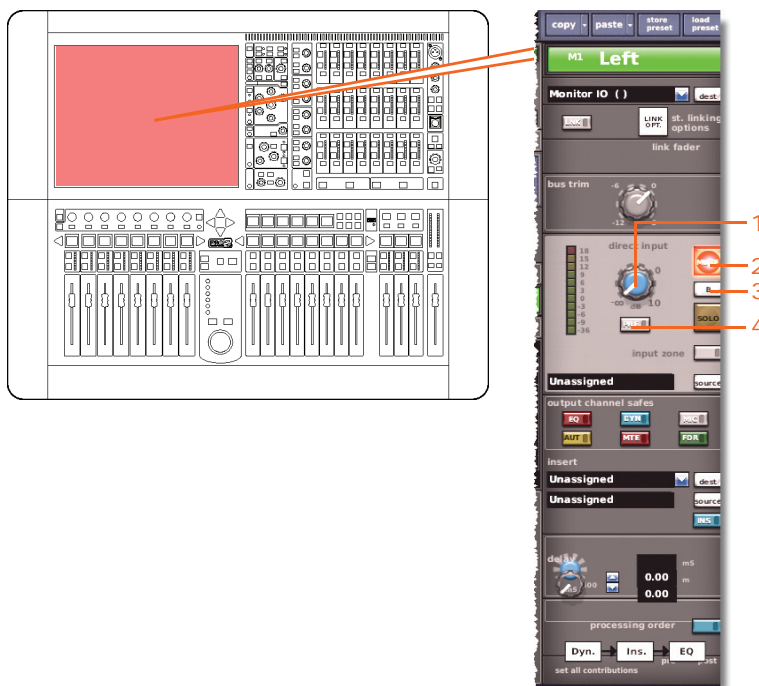

<i>Item</i>	<i>Control</i>	<i>Parameter</i>
1	level control knob	Direct input level
2	MUTE switch	Direct input mute on/off
3	SOLO B/[B] switch	Direct input solo B on/off
4	MODE/[PRE] switch	Direct input pre- in/out



Comp./Output Dyn

The following diagram shows the parameters of the compressor detail area copied through scenes. Only corrective compressor shown below, but typically the same for the other compressor modes.

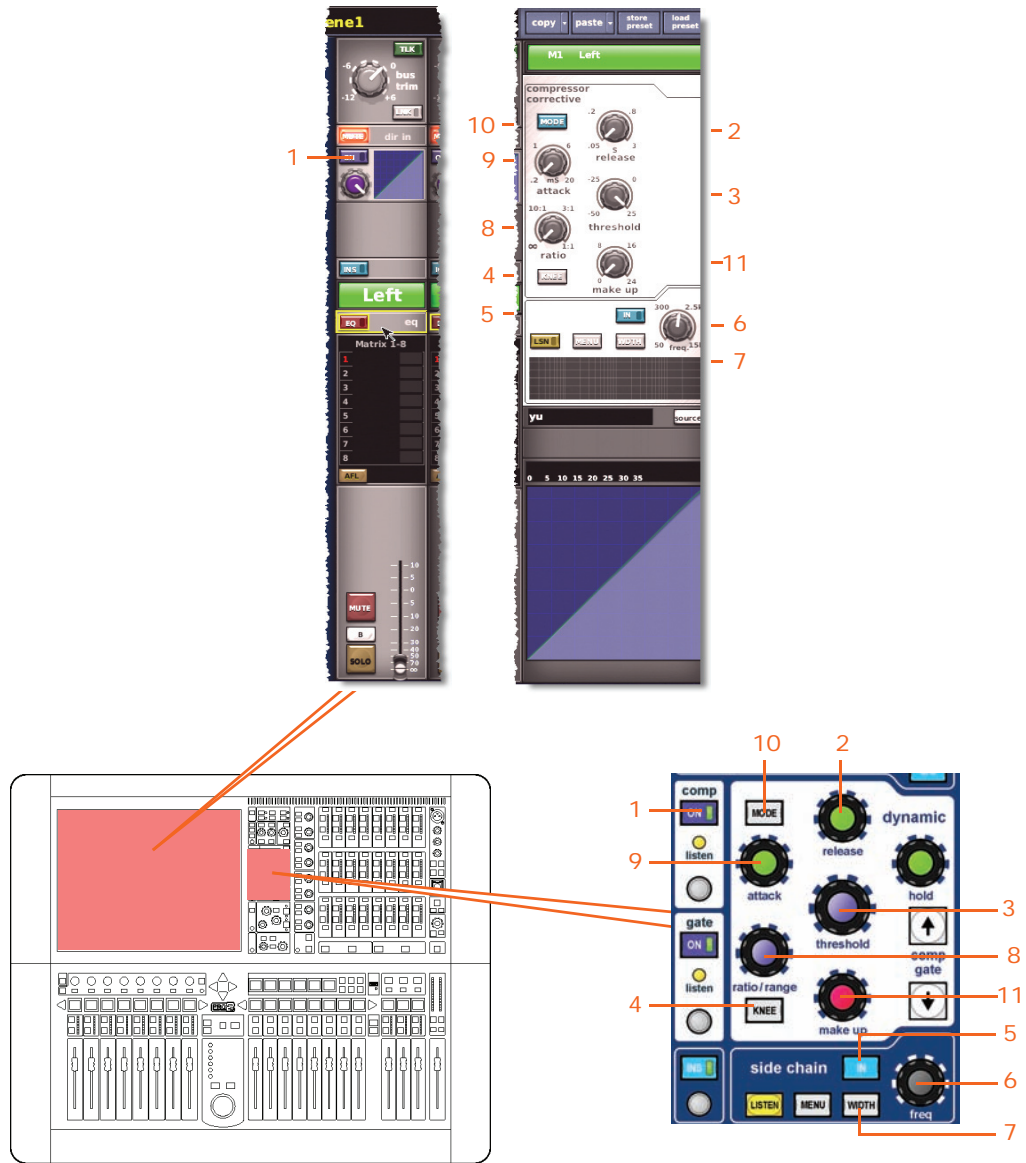

Item	Control	Parameter
1	ON switch	Compressor on/off
2	release control knob	Compressor release
3	threshold control knob	Compressor threshold
4	KNEE pushbutton	Compressor knee: hard, medium or soft
5	IN switch	Compressor sidechain in/out
6	freq control knob	Compressor sidechain frequency

<i>Item</i>	<i>Control</i>	<i>Parameter</i>
7	<b>WIDTH</b> pushbutton	Compressor sidechain width: 2 Oct, 1 Oct or 0.3 Oct
8	<b>ratio</b> control knob	Compressor ratio
9	<b>attack</b> control knob	Compressor attack
10	<b>MODE</b> pushbutton	Compressor mode: corrective, adaptive, creative, vintage or shimmer
11	<b>make up</b> control knob	Compressor gain

---

### Gates

Not applicable.

**EQs**

The following diagram shows the parameters of the EQ detail area copied through scenes.

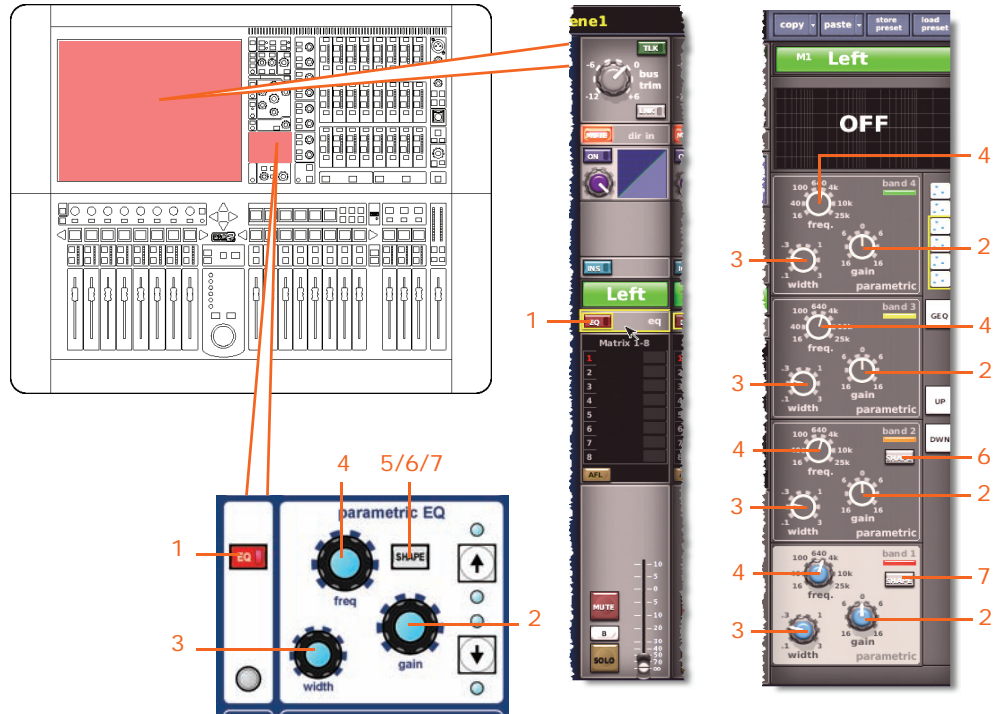

Item	Control	Parameter
1	EQ switch	EQ on/off
2	gain control knob	EQ gain level
3	width control knob	EQ width
4	freq control knob	EQ frequency
5*	SHAPE switch	Band 6 shelving mode: bell, soft, low pass 6dB or low pass 12dB
6	SHAPE switch	Band 2 shelving mode: bell or high pass 24dB
7	SHAPE switch	Band 1 shelving mode: bell, warm, high pass 6dB or high pass 12dB

\* Not shown in diagram.

**Note:** Although bands 5 and 6 are not shown above, the items in the table also apply. Both bands have items 2, 3 and 4, and band 6 also has item 7.

**Aux Sends (1 to 16)**

Not applicable.

**Matrix Sends (1 to 8)**

The following diagram shows the parameters of the mix detail area copied through scenes.

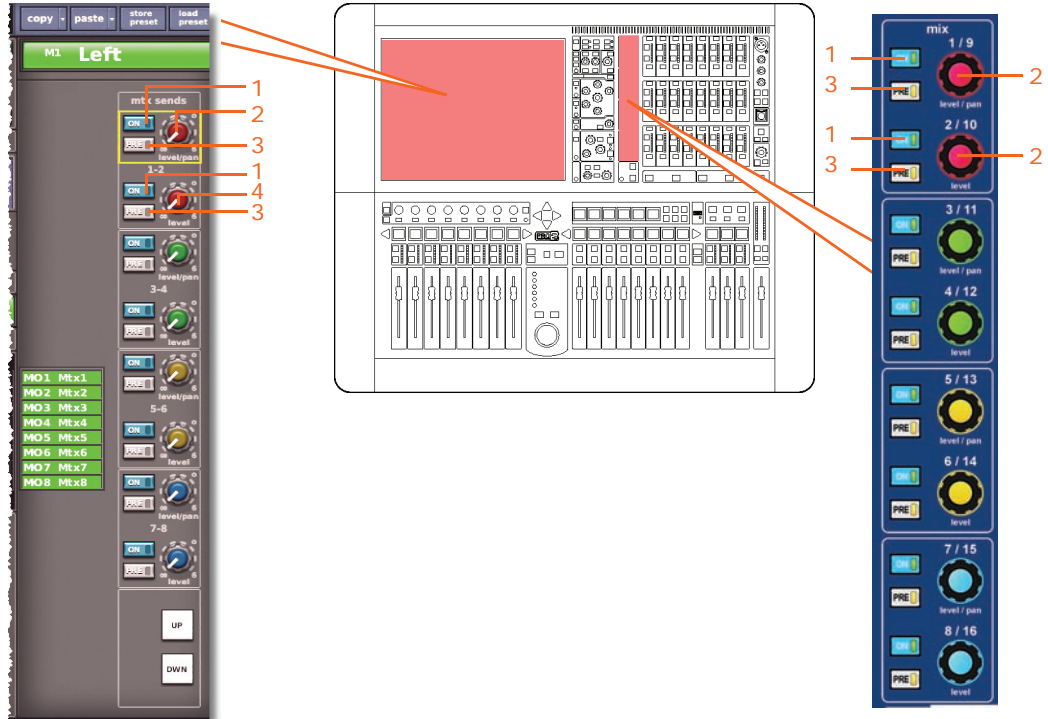

<i>Item</i>	<i>Control</i>	<i>Parameter</i>
1	<b>ON</b> switch	Matrix bus send on/off
2	<b>level/pan</b> control knob	Bus level, or pan when bus is linked
3	<b>PRE</b> switch	Pre-fader on/off
4	<b>level</b> control knob	Bus level

**Note:** Although only matrix sends 1-2 are referenced above, this also applies to all eight matrix sends.

Fader Sections

The following diagram shows the parameters of the master routing detail area copied through scenes.

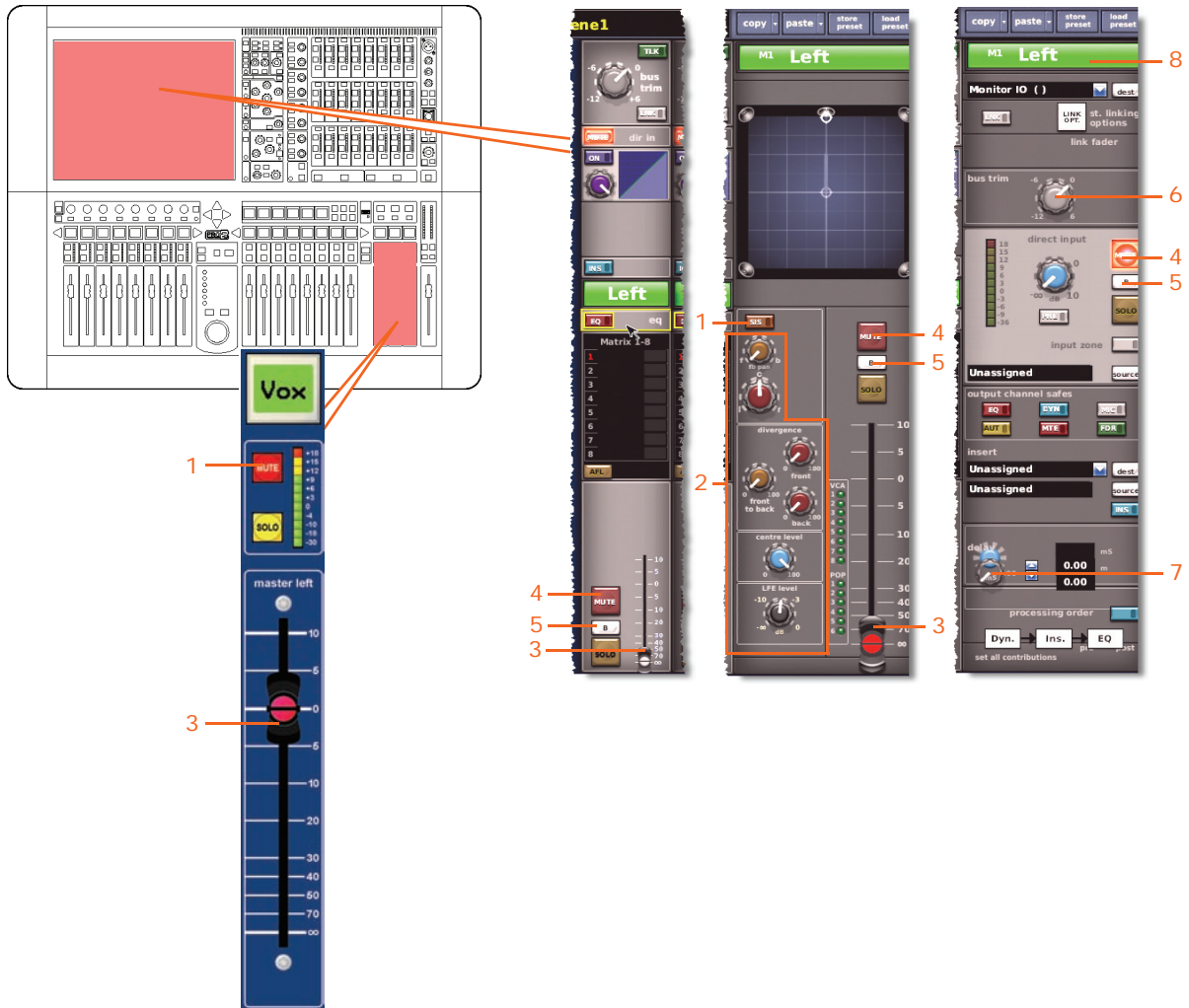

Item	Control	Parameter
1	<b>SIS</b> switch	Spatial imaging system on/off
2	Panning control knobs	Surround panning (includes all surround sound parameters)
3	Fader	Level
4	<b>MUTE</b> switch	Mute on/off
5	<b>SOLO B/[B]</b> switch	Solo B in/out
6	<b>bus trim</b> control knob	Bus trim level
7	<b>delay</b> control knob	Delay time
8	Field	Channel colour

Recall Scope

For details, see "Masters" on page 369.

**Store Scope**

For details, see “Masters” on page 369.

**Routing**

The following diagram shows the master channel routing parameters copied through scenes.

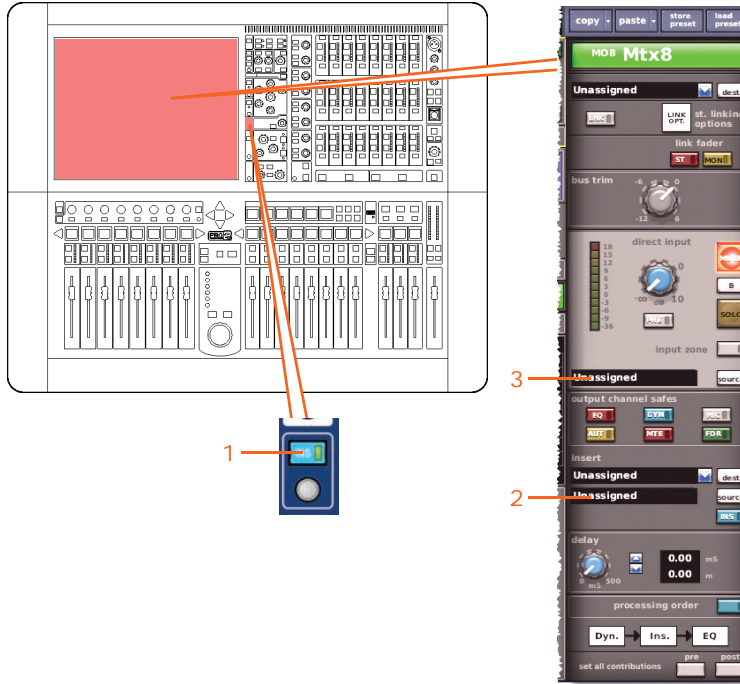

<i>Item</i>	<i>Control</i>	<i>Parameter</i>
1	INS switch	Insert in/out
2	Field	Insert return source*
3	Field	Direct input source*

\* Only automated when automate patching is on.

## Misc (miscellaneous)

The **Misc** section has an **Assignables** option, which lets you copy the current control assignments of the **Assignable Controls** window through scenes. (The levels are not copied.)

None of the options in the **Sections** area are applicable to this option.



For more information on assignable controls, see Chapter 19 "Assignable Controls" on page 153.





## Appendix L: Service Information

The service manual for this equipment is available for purchase. Please contact your local distributor for details.

### Electrostatic discharge (ESD) precautions



Observe full electrostatic discharge (ESD) — also known as “anti-static” — precautions when carrying out procedures in this manual that are accompanied by the ESD Susceptibility Symbol (shown above). This caution symbol shows you that ESD damage may be caused to items unless proper ESD precautions are taken, which include the following practices:

- Keep the work area free from plastic, vinyl or styrofoam.
- Wear an anti-static wrist strap.
- Discharge personal static before handling devices.
- Ground the work surface.
- Avoid touching ESD-sensitive devices.

### Routine maintenance

To help keep your PRO2 Control Centre unit in good working order and to make sure it gives you optimum performance, we recommend that you carry out the following about once every month.

- Clean the control centre, as detailed in “Cleaning the control centre” below.
- Check controls for freedom of operation. As the controls are ‘self-cleaning’, this operation will help to prevent them from sticking.
- Check functionality of all controls, that is, control knobs, faders, pushbuttons, LEDs etc.
- Check functionality of equipment.

### Cleaning the control centre

Switch off the control centre and electrically isolate it from the mains before cleaning.

Clean the control centre using a dry, lint-free cloth. Do not use harsh abrasives or solvents. When cleaning the unit, take great care not to damage faders, pushbuttons etc.

## Cleaning the GUI screen

Switch off the control centre and electrically isolate it from the mains before cleaning.

Carefully wipe the surface of the GUI screen with a soft, lint-free cloth or screen wipe specially designed for the purpose. When cleaning the GUI screen please take the following precautions:

- Avoid putting pressure on the screen.
- Don't use harsh abrasives, for example, paper towels.
- Don't apply liquids directly to the screen.
- Don't use ammonia-based cleaners and solvents, such as acetone.

If you are in doubt have any queries about cleaning the GUI screens, please don't hesitate to contact us.

## Equipment disposal

When this equipment has come to the end of its useful life, its disposal may come under the DIRECTIVE 2002/96/EC OF THE EUROPEAN PARLIAMENT AND OF THE COUNCIL of 27 January 2003 on waste electrical and electronic equipment (WEEE).

Hazardous substances in WEEE contaminate water, soil and air and ultimately put at risk our environment and health. The directive aims to minimize the impacts of WEEE on the environment during their life times and when they become waste.

The WEEE directive addresses the disposal of products when they have reached the end of their life and contributes to the reduction of wasteful consumption of natural resources. This will help to reduce pollution, and protect the environment and ourselves.



If this equipment carries a 'crossed-out wheellie bin' (shown left), please do not dispose of WEEE as unsorted municipal waste but collect and dispose of in accordance with local WEEE legislation. The horizontal bar underneath indicates that the product was placed on the EU market after 13th August 2005.

For WEEE disposal; see our website at [www.midasconsoles.com](http://www.midasconsoles.com) for information.

# Glossary

This section provides an explanation of some of the symbols, terms and abbreviations used in this manual.

**5.1 surround:** A surround sound system created from six channels that form a discrete signal, which is played back over a speaker system comprising five speakers (three front and two rear) and a subwoofer (which is the “.1” or LFE channel). See *LFE*.

**μ:** Micro- prefix symbol that represents 10<sup>-6</sup> or one millionth.

## A

**A/D:** Abbreviation for “analogue to digital”. The conversion of a continuous signal into a numeric discrete sample sequence.

**AC:** Abbreviation for “alternating current”.

**Acoustic feedback:** A sound loop existing between an audio input and audio output that is amplified on each cycle. For example, a mic input signal is amplified and passed to a loudspeaker. The output from the loudspeaker is picked up by the mic, which amplifies it again and passes it back to the loudspeaker, and so on.

**AES/EBU:** Abbreviation for “Audio Engineering Society/European Broadcasting Union”; see *AES3*.

**AES3:** Also known as “AES/EBU”, this is a serial interface for transferring digital audio between devices.

**AES50:** AES digital audio engineering standard. AES50 is a high resolution, multi-channel audio interconnection (HRMAI). Rather than a network, it is a high-performance, point-to-point audio interconnection, although the auxiliary data may operate as a true network, independently of the audio. HRMAI provides a professional multi-channel audio interconnection that uses Cat 5e data cable and is compatible with Ethernet networks.

**AFL:** Abbreviation for “after fader listen”. A function that allows the signal to be monitored post-fader, that is, after it has been acted upon by the fader.

**Algorithm:** In computing, a set of instructions for accomplishing a specific task.

**amp (A):** Abbreviation for “ampere”. A unit of current.

**Anti-aliasing:** When referring to digital images, a technique that avoids poor pixelation.

**Area A:** Primary input control area.

**Area B:** Secondary input control area.

**Assignable controls:** Any controls, such as select buttons (LCD switches), that can be set up by the user to control any function required.

**Auto safe:** Prevents channel from accepting scene recall.

**Auto-mute:** A function that automatically mutes the channel’s signal under certain conditions.

**Auto-mute group:** A function that automatically mutes a number of selected channels under certain conditions.

**Automation:** 1. Memorization and playback of changes made to mixer settings. 2. An area on the output bay that controls these.

**Aux:** Abbreviation for “auxiliary send” or “aux send”. A designation for extra buses, typically used for sending signal to effects, headphone amps and other destinations. See *Bus*.

**Aux send:** See *Aux*.

## B

**Balanced audio:** A type of audio connection that uses the three leads in a cable, connector and jack as part of a phase-cancelling arrangement to boost the signal and reduce noise.

**Band:** In EQ, a range of frequencies.

**Bandwidth:** In EQ, the width of a band, that is, the number of frequencies that will be boosted/cut above and below a centre frequency.

**Bank:** A fixed number of channels.

**Bass:** Lower frequencies in a signal.

**Bay:** One of the five main control centre modules, which contains a control surface and a GUI screen.

**Bus:** A pathway down which one or more signals can travel.

## C

**Cat 5e:** A specification for a type of cable used typically for Ethernet computer networks.

**Channel:** Single path taken by an audio signal (input or output) through the control centre.

**Channel strip:** Row of controls in traditional analogue layout used for the shaping of a signal.

**Checkpoint:** A patching data store point, created by clicking **CHECKPOINT**. See *Patching*.

**Click:** A method of GUI operation, mainly for button operation and selection purposes.

**CMR:** Abbreviation for “common mode rejection”. A measure of how well a differential amplifier rejects a signal that appears simultaneously and in-phase at both input terminals. CMR is usually stated as a dB ratio at a given frequency.

**Comb filtering:** Removal of signal components at a number of regularly spaced frequencies.

**Compressor:** A dynamics processor that reduces the level of any signal exceeding a specified threshold volume.

**Condenser microphone:** A high quality mic that uses a capacitor to detect changes in the ambient air pressure, which it then converts into an electrical signal. This type of mic requires power from a battery or external source.

**Control centre:** The console of the PRO2, comprising control surface and GUI.

**Control surface:** Area on the control centre that houses all of the user’s hardware controls, such as pushbuttons, control knobs, switches etc.

**Crossfade:** To combine signals such that one channel or source fades out while another fades in, but maintaining an essentially constant programme volume. Also known as “X-fade” or “xfade”.

**Cursor:** Generally, used to describe the “I”-shaped pointer on the GUI that indicates a text insertion point. See *Pointer*.

## D

**D zone:** Section in the input channel strip for controlling dynamic parameters.

**D/A:** Abbreviation for “digital to analogue”. The conversion of digital data to analogue audio.

**DARS:** Abbreviation for “digital audio reference signal”.

**Dashboard:** A standard GUI screen display - usually on the output bay - that shows all channel meters (inputs, auxes, returns, masters etc.) all of the time.

**dB:** Symbol for “decibel”. A unit of measurement of the loudness of sound. See *dBu*.

**dBu:** A unit of measurement of sound used in professional audio. Derived from the decibel, where the “u” stands for unloaded, this unit is an RMS measurement of voltage based on  $0.775V_{RMS}$ , which is the voltage at which you get 1mV of power in a 600 ohm resistor. This used to be the standard impedance in most professional audio circuits.

**DC:** Abbreviation for “direct current”.

**Delay:** An effect by which a reproduction of a signal is played back later than its original.

**Destination:** In patching, the patch connector to which a signal is routed. See *Patching*.

**Detail area:** a control section in the channel strips.

**Device:** A diagram(s) on the I/O tabs (GUI patching) representing a physical rack unit, such as a line I/O, mic splitter, DN9696, AES50 etc. See *Patching*.

**DHCP:** Abbreviation for “dynamic host configuration protocol”. A network configuration protocol for IP network hosts.

**DI:** Abbreviation for “direct inject” or “direct injection”. Signal is plugged directly into the audio chain without using a microphone.

**DI box:** Device for matching the signal level impedance of a source to mixer input.

**Divergence:** The spreading of sound waves from a source in a free field environment, that is, one with no reflections. Causes the sound pressure levels in the far field of the source to decrease as the distance from it increases.

**Drag:** A method of GUI operation, mainly for control adjustment. Also used for selecting blocks of patch connectors during patching.

**DSP:** Abbreviation for “digital signal processing” or “digital signal processor”. Any signal

processing done after an analogue audio signal has been converted into digital audio. Can be used to create, for example, compression, equalization etc., of a digital signal. A digital signal processor is a piece of equipment specifically designed for carrying out signal processing.

## E

**E zone:** Section in the input channel strip for controlling EQ parameters.

**Effect:** One of a number of audio processes that can be applied to a signal to modify it, such as reverb, flanging, phasing, delay etc.

**Effects rack:** On the PRO2 GUI, a virtual rack of internal processors. See *Virtual rack*.

**Envelope:** 1. How a sound or audio signal varies in intensity over time. 2. The visual representation of such, usually shown on a graph in a GUI channel strip.

**EQ:** Abbreviation for "equaliser" or "equalisation".

**Equalisation:** Adjusting the frequency response so that the levels of all frequencies are equal or the same. Bass and treble controls are equalization controls.

**EtherCon®:** A cable connector for data transfer interconnections, which is more robust than the basic RJ45.

## F

**Fader:** Slider-type device for precise adjustment of signal level or volume of a channel.

**Fast strip:** A channel strip in one of the fast zones. See *Fast zone*.

**Fast zone:** An area on a bay that contains quick controls. See *Fast strip*.

**FB:** Abbreviation for "front-back". A term used in surround panning.

**Feedback:** See *Acoustic feedback*.

**Filter:** A device for removing frequencies above or below certain levels.

**FOH:** Abbreviation for "front of house". The area in a theatre used by the public. Used to describe a console/control centre being used to control the sound that the audience will hear (and not the performers' monitor system).

**Frequency:** The number of times that a sound wave's cycle repeats within one second.

**Fricative:** A consonant, such as "f" or "s", produced by the forcing of breath through a constricted passage.

**From section:** The leftmost area of the patching screen that contains the source patch connectors. See *Patching*.

**FX:** Abbreviation for "sound effects".

## G

**Gain:** Another term for signal level.

**Gain reduction (compressor):** Decrease in gain when input signal is above threshold. See *Gain*.

**GEO:** Abbreviation for "graphic equaliser". See *Graphic EQ*.

**GEO rack:** A virtual rack of GEOs. See *Virtual rack*.

**Glide pad:** Device for controlling the GUI. See *Navigation zone*, *Touchpad* and *Trackball*.

**Granularity:** A measure of the size of components or a description of the components comprising a system.

**Graphic EQ:** A form of EQ that has a number of faders for controlling the gain of the audio signal. The faders are set at frequency bands that are evenly-spaced according to octaves.

**GUI:** Abbreviation for "graphical user interface".

**GUI channel strip:** Rightmost section of a GUI screen that represents the detail area of the input or output channel strip selected to the control surface.

**GUI menu:** A menu selectable at either GUI screen by clicking the **home** button (upper-left corner).

**GUI screen:** One of the PRO2's five screens, which comprise the GUI.

## H

**HPF:** Abbreviation for "high pass filter". A filter that removes lower frequencies from a signal, leaving the higher frequencies unaffected.

**Hum:** Undesirable low frequency tone present in a signal due to grounding problems or proximity to a power source.

**Hz:** Symbol for "Hertz". A unit of frequency equal to one cycle of a sound wave per second.

## I

**I zone:** Area on the output bay that contains the operator-assignable controls.

**I/O:** Abbreviation for “input/output”.

**ID:** Abbreviation for “identification”.

**Ident:** Scale marking, or gradation, around a control knob to help indicate the current setting and to assist in accurate adjustment.

**Impedance (Z):** Opposition to the flow of alternating current in a circuit, measured in ohms.

**Input:** 1. The signal being received by a device. 2. The physical location of where a device receives a signal. 3. Concerning the input bays on the PRO2 control surface.

**IP:** Abbreviation for “internet protocol”. Principal network communications protocol.

## K

**k:** Kilo- prefix symbol that represents  $10^3$  or one thousand, for example, kHz (one thousand Hz) or km (one thousand metres).

**Kernel:** For computers, the kernel is the central component of most operating systems.

## L

**LCD:** Abbreviation for “liquid crystal display”.

**LCR:** Abbreviation for “left-centre-right”, referring to speakers.

**LED:** Abbreviation for “light emitting diode”.

**Level:** General term for volume or amplitude.

**LF:** Abbreviation for “low frequency”.

**LFE:** Abbreviation for “low frequency effects”. A discrete channel intended for playback through a subwoofer speaker, although it can be fed to any speaker that can handle low frequency signals. LFE is generally used to enhance sound effects in films and is, typically, the “.1” in “5.1 surround”. LFE is not full bandwidth (range). Examples of LFEs are: thunder, explosions and other bass effects.

**LHS:** Abbreviation for “left-hand side”.

**Limiter:** An extreme form of compressor that only affects signals above a selected threshold level (dB).

**Linux:** Also known as “Linux kernel”. Operating system kernel used by a family of Unix-like operating systems. See *kernel*.

**LPF:** Abbreviation for “low pass filter”. A filter that removes higher frequencies from a signal, leaving the lower frequencies unaffected.

**LS:** Abbreviation for “left surround”. The left rear speaker in a 5.1 surround system.

## M

**m:** 1. Prefix symbol for “metre(s)”, for example, as in “200 m” (200 metres); please note the intermediate space. 2. Prefix symbol for milli-, which represents  $10^{-3}$  or one thousandth, for example, as in “2ms” (2 milliseconds); there is no intermediate space.

**MADI:** Abbreviation for “multi-channel audio digital interface”. An AES standard for digital interconnection between multi-track recorders and mixing consoles.

**Main bus:** A type of bus; see *Bus*.

**Masters:** The three master channels (mono and stereo left and right) in the output bay.

**MB:** Abbreviation for “megabyte”.

**MC:** Abbreviation for “master controller”.

**MCA:** Abbreviation for “mix control associate”.

**Meter:** Visual device to indicate the level of a signal.

**Mic:** Abbreviation for “microphone”.

**Microphone:** Device for converting sound waves into audio signals.

**MIDI:** Acronym for “musical instrument digital interface”. A digital signal system standard that facilitates integration of musical instruments, such as synthesizers and guitars, with computers.

**Mix:** 1. A signal that contains a combination of signals, such as a pair of stereo signals with numerous effects. 2. The act of creating such a combination. 3. A type of bus (see *Bus*). 4. Concerning the mix bay on the PRO2 control surface.

**Mixer:** 1. A console or other device that blends input signals into composite signals for output. 2. An engineer/technician who carries this out, especially during a live performance.

**mm:** Symbol for “millimetre” (one thousandth of a metre).

**MON:** Abbreviation for “monitor”, used to describe a console/control centre being used to mix the signals sent to the stage monitor speakers.

**Monitor:** 1. Speaker(s) used for listening to a mix or live audio. 2. The act of listening to a mix or live audio. 3. Concerning the primary or secondary monitor bus system, A or B respectively.

**Monitors:** Control area on the master bay for monitoring the A and B signal paths.



**Mono:** A single signal.

**Mute:** Function that allows a channel's signal to be silenced.

**Mute safe:** Function that means a mute cannot be controlled by scene recall or auto-mutes.

## N

**N/A:** Abbreviation for "not applicable".

**Navigation:** The act of directing channels or buses to the control surface for selection, mixing, processing etc.

**Navigation zone:** Area on the control surface concerning navigation.

**nm:** Symbol for nanometre (one billionth of a metre).

**Normalisation:** An automatic process whereby the gain of all program material is adjusted so that the peak level will just arrive at 0dB.

**Normalise:** To boost the amplitude of a digital sound so that it is as high as it can be without clipping (0dB).

**Normalised connection:** Also known as "normalised connection". A connection that allows a signal to pass through it when no plug is inserted in it, but breaks the connection when a plug is inserted.

**Normalising:** The process of making audio files the same volume.

**NVRAM:** Abbreviation for "Non-volatile random access memory". This is the general name used to describe any type of RAM that retains its information when power is switched off. For example, flash memory.

## O

**O/B:** Abbreviation for "outside broadcast".

**Oct:** Abbreviation for "octave".

**Octave:** A difference in pitch where one tone has a frequency that is double or half of the frequency of another tone.

**ohm ( $\Omega$ ):** Unit of electrical resistance.

**OpticalCon@:** A cable connector for fibre optic cables.

**OS:** Abbreviation for "operating system".

**OSC:** Abbreviation for "oscillator" or "oscillation".

**Out of phase:** 1. A signal, being similar to another in amplitude, frequency and wave shape, but offset in time by part of a cycle.

2. 180° out of phase or having opposite polarity. See *Phase*.

**Outboard:** External, as in an "external device".

**Outboard equipment:** External equipment used with the DL251/DL252 Audio System I/O, but that is not part of it.

**Output:** 1. The signal put out by a device. 2. The physical location of where a device sends out a signal. 3. Concerning the output bay on the PRO2 control surface.

**Overload:** A condition where the signal level is too high.

## P

**Pan:** To move from one side to another or up and down.

**Panning:** The left/right positioning of a signal across a stereo image.

**Parameter:** A setting whose value can be altered by the user.

**Parametric EQ:** A type of EQ that allows all of the parameters of equalisation to be changed, including centre frequency, boost/cut in gain, and bandwidth.

**Patch:** A temporary connection (physical or virtual) made between two audio devices or inside one.

**Patch connector:** Any tab patching point, for example, an XLR connector, bus, sidechain compressor etc. See *Patching*.

**Patching:** Also known as "soft patching". The process of routing a channel/signal from a source to a destination(s).

**PCB:** Abbreviation for "printed circuit board".

**PEQ:** Abbreviation for "parametric equaliser". See *Parametric*.

**PFL:** Abbreviation for "pre-fade listen". A function that allows the signal to be monitored pre-fader, that is, before it reaches the fader.

**Phantom power:** The power required for the operation of a condenser microphone when it is not supplied by internal batteries or a separate power supply. This is supplied by the DL251/DL252 Audio System I/O itself.

**Phase:** A measurement (in degrees) of the time difference between two waveforms.

**Pitch:** A continuous frequency over time. Musical interpretation of an audio frequency.

**Pitch shift:** Alteration of pitch or frequency, but without adjusting tempo.

**Point scene:** Subdivision of a scene. See *Scene*.

**Pointer:** 1. On the GUI, the pointer is the arrow-shaped object on the screen that moves when the user moves the trackball or external mouse. 2. On a control knob, it is the marking that, when used in conjunction with the indent around edge of control knob, helps to indicate the setting.

**POP group:** A number of channels assigned to a group that has unfold and area B controls. Provides an easy and quick method of manipulating and controlling the numerous channels available on the DL251/DL252 Audio System I/O.

**Post-:** The point for accessing audio just after it leaves a specific channel component, for example, "post-fader", where the audio is tapped from just after it leaves the channel's main level control.

**Pre-:** The point for accessing audio just before it reaches a specific module, for example, "pre-EQ", where the audio is tapped from just before it gets to a channel strip's EQ.

**Psychoacoustic noise:** Noise that affects the physiology of the listener.

**PSU:** Abbreviation for "power supply unit".

**Psychoacoustics:** The study of the perception of sound, that is, how we listen, our psychological responses and the physiological effects on the human nervous system.

## Q

**Quick access button:** Button for quickly selecting its associated strip section.

## R

**RAM:** Abbreviation for "Random access memory".

**Return:** Auxiliary return or aux return. An extra input used for receiving a signal from the output of an internal or external effect processor. See *Bus*.

**Reverb:** An effect where the ambience of a physical space is simulated. This is done by copying a signal and replaying at regular intervals at ever decreasing levels. The intervals are so close that each copy is not heard individually.

**RHS:** Abbreviation for "right-hand side".

**RMS:** Abbreviation for "root-mean-square". The square root of the mean of the sum of the squares. Commonly used as the effective value

of measuring a sine wave's electrical power. A standard in amplifier measurements. The effective average value of an AC waveform.

**RS:** Abbreviation for "right surround". The right-hand rear speaker in a 5.1 surround system.

## S

**s:** Symbol for "second"; a unit of time.

**Scene:** In automation, a set of mix settings for a particular part of a play or song.

**Sibilance:** Energy from a voice, centred around 7kHz, caused by pronouncing "s", "sh" or "ch" sounds.

**Side chain:** A special circuit that diverts a proportion of the main signal so that it can be processed, as required. Compressors use the side chain to derive their control signals.

**Signal flow:** The path of a signal from one place to another.

**SIP™:** Abbreviation for "solo in place".

**SIS:** Abbreviation for "spatial imaging system". Combines a central loudspeaker cluster with a left-right system to form three discrete sound channels.

**Snapshot:** A captured group of mixer settings that reflect the state of the mixer at a particular moment within a performance. This snapshot can then be recalled at the required moment in the performance/playback.

**Solo:** During monitoring, the isolation of one signal by silencing all other signals.

**Source:** The patch connector from which a signal is patched. See *Patching*.

**SPL:** Abbreviation for "sound pressure level". Given in decibels (dB), SPL is an expression of loudness or volume.

**Splash screens:** The GUI display during power up.

**SRC:** Abbreviation for "sample rate converter".

**SSD:** Abbreviation for "solid-state disk". Data storage device that uses non-volatile memory to store data. Quicker than the conventional hard disk and less susceptible to the failures associated with hard disk drives.

**Status indicator:** A device specifically designed to show the condition of something. For example, an LED that shows whether a pushbutton is on or off, or a meter showing the level of a signal.



**Stereo:** Two separate channels, left and right, used to give the listener the perception of where the noise is coming from. Usually used with music to give a fuller, more natural sound.

**Stereo image:** The perception of the different sound sources coming from far left, far right or anywhere in between.

**Surround:** Audio that has more than two speaker locations and, therefore, more than two channels. Also commonly termed “surround sound”.

**Sync:** Abbreviation for “synchronisation”.

**Synchronisation:** Coordination of timing between devices.

## T

**Tab:** A ‘sheet’ in the **From** and **To** sections of the **Patching** screen (GUI) that contains a specific group of patch connectors. See *Patching*.

**Talk output panel:** Routing system for talking out from the console.

**TFT:** Abbreviation for “thin film transistor”.

**Threshold:** Level at which dynamics processing will begin to operate.

**Tie line:** A dedicated connection between two systems, typically between FOH and MON positions.

**To section:** The rightmost area of the Patching screen that contains the destination patch connectors. See *Patching*.

**Tooltip:** The information box that appears next to the cursor on some GUI screens when it is on or near certain items, such as the channels on the **Dashboard** screen or patch connectors on the **Patching** screen.

**Touchpad:** Also known as “trackpad”. An input device on a laptop PC for controlling the on-screen pointer. See *Glide pad* and *Trackball*.

**Track:** Single stream of recorded audio data.

**Trackball:** Device for controlling the GUI. See *Navigation zone*, *Glide pad* and *Trackball*.

**Treble:** Higher frequencies in a signal.

**Tunnelling Ethernet:** Mechanism by which to transport a foreign protocol across a network that normally wouldn’t support it.

**TW:** Abbreviation for “twin wire”.

## U

**Unbalanced audio:** A type of audio connection that utilises only two of the leads of a cable, connector and jack.

**Unfold:** Navigates the input channels of a group to the input bays.

**USB:** Abbreviation for “universal serial bus”. A ‘plug and play’ interface that provides a fast connection between a computer and peripherals, such as keyboards, printers, scanners, digital cameras etc.

## V

**VCA:** Abbreviation for “variable control association”, as in VCA group (also “voltage controlled amplifier”).

**VCA fader:** The fader control of a VCA group.

**VCA group:** A group of channels that are controlled globally, such as via their group’s fader and other controls. Provides an easy and quick method of manipulating and controlling the numerous channels available on the DL251/DL252 Audio System I/O. See *VCA*.

**VGA:** Abbreviation for “video graphics array”. A graphics display system for PCs developed by IBM.

**Virtual rack:** A traditional 19” rack, represented on the GUI. A virtual rack will, typically, contain internal devices, such as effects and GEQs.

**volt (V):** A unit of electrical potential differential or electromotive force.

**Volume:** General term for a signal’s loudness.

**VU meter:** Abbreviation for “volume unit meter”.

## W

**Window:** A small self-contained panel that appears on the GUI, usually after selection of a specific control. Typically, contains a number of user-selectable options or information in the form of a message or prompt.

## X

**X-fade:** Abbreviation for “crossfade”.

**X-over:** Abbreviation for “crossover”.

**XLR connector:** High-quality three-pin audio connector, which is also used for AES/EBU digital audio connections.

# Other important information

**1 Register online.** Please register your new Midas equipment right after you purchase it by visiting [www.midasconsoles.com](http://www.midasconsoles.com). Registering your purchase using our simple online form helps us to process your repair claims more quickly and efficiently. Also, read the terms and conditions of our warranty, if applicable.

**2 Malfunction.** Should your MUSIC Group Authorized Reseller not be located in your vicinity, you may contact the MUSIC Group Authorized Fulfiller for your country at [www.midasconsoles.com](http://www.midasconsoles.com). If your country is not listed please contact the "United Kingdom (Midas/KT main office)" located under "Service ↳ Service/Repairs" on the [www.midasconsoles.com](http://www.midasconsoles.com) website. Alternatively, please submit the online warranty return form found under "Service ↳ Warranty Registration" on [www.midasconsoles.com](http://www.midasconsoles.com) BEFORE returning the product. All enquires must be accompanied by the description of the problem and the serial number of the product. The warranty eligibility will be verified from the original sales receipt.

**3 Power Connections.** Before plugging the unit into a power socket, please make sure you are using the correct mains voltage for your particular model. Faulty fuses must be replaced with fuses of the same type and rating without exception.

## FEDERAL COMMUNICATIONS COMMISSION COMPLIANCE INFORMATION



Responsible party name: MUSIC Group Research UK Limited

Address: Klark Industrial Park, Walter Nash Road, Kidderminster. Worcestershire. DY11 7HJ. England.

Phone/Fax No: Phone: +44 1562 741515  
Fax: +44 1562 745371

### PRO2 Live Audio System

complies with the FCC rules as mentioned in the following paragraph:

This equipment has been tested and found to comply with the limits for a Class A digital device, pursuant to Part 15 of the FCC Rules. These limits are designed to provide reasonable protection against harmful interference when the equipment is operated in a commercial environment. This equipment generates, uses, and can radiate radio frequency energy and, if not installed and used in accordance with the instruction manual, may cause harmful interference to radio communications. Operation of this equipment in a residential area is likely to cause harmful interference in which case the user will be required to correct the interference at his own expense.

### Important information:

Changes or modifications to the equipment not expressly approved by MUSIC Group can void the user's authority to use the equipment.



Thank you for reading through this Operator Manual.  
We hope you found it useful.

Please feel free to send us your comments. Our  
contact details and website address can be found at  
the front of this document.



MUSIC Group Research UK Limited  
Klark Industrial Park, Walter Nash Road,  
Kidderminster. Worcestershire. DY11 7HJ. England.  
Tel: +44 1562 741515, Fax: +44 1562 745371  
Email: [mkt.info@music-group.com](mailto:mkt.info@music-group.com)  
Website: [www.midasconsoles.com](http://www.midasconsoles.com)